



# World Interfaith Harmony Week

Official UN Week: First Week of February  
Resolution UNGA A/65/PV.34



On September 23<sup>rd</sup> 2010, HM King Abdullah II of Jordan introduced a World Interfaith Harmony Week at the Plenary Session of the 65<sup>th</sup> UN General Assembly in New York.

For this unprecedented global harmony initiative HM King Abdullah II of Jordan was recognized in the Global Harmony Association (GHA) as  
WORLD HARMONY CREATOR  
[www.peacefromharmony.org/?cat=en\\_c&key=513](http://www.peacefromharmony.org/?cat=en_c&key=513)

# Spiritual Culture for Harmonious Civilization

**Citizens of Earth!**

Unite in harmony for love, peace, justice, fraternity and happiness!



## Global Harmony Association (GHA)

Since 2005, GHA is an international NGO uniting more than 500 members in 56 countries and more than one million participants from the GHA collective members in 80 countries.

Web: [www.peacefromharmony.org](http://www.peacefromharmony.org)

**Board: 37 GHA members from 14 countries**

[www.peacefromharmony.org/?cat=en\\_c&key=249](http://www.peacefromharmony.org/?cat=en_c&key=249)

**GHA Founder and President: Dr. Leo Semashko**

Address: 7/4-42 Ho-Shi-Min Street, St. Petersburg, 194356 Russia

E-mail: [leo.semashko@gmail.com](mailto:leo.semashko@gmail.com) Web: [www.peacefromharmony.org/?cat=en\\_c&key=253](http://www.peacefromharmony.org/?cat=en_c&key=253)

GHA Mission is:

*To bring peace from harmony and to pave a conscious way for harmonious civilization on scientifically based 'ABC of Harmony' through harmonious education*

# World Interfaith Harmony: Internal Harmonious Potential of Religions and General Scientific Platform of *the ABC of Harmony* Interfaith Harmony Educational Project of the GHA

## Project Meaning

The UN World Interfaith Harmony Week is the second great intuitive step of humanity to global harmony and harmonious civilization after the Congress of World Religions in 1893, Chicago. The highest purpose and subject of the GHA Project of World Interfaith Harmony is to make this step from the intuitive into scientific-conscious one and commit it on the fundamentally new way of global harmonious education at the ABC of Harmony base. It is its ultimate meaning. The Project authors suggest to hold of the Third World Religions Congress "Global Interfaith Harmony Education" in 2015, under the UN aegis.

The GHA key proposal to Jordan's King HM Abdullah II in our Project is: To organize the Third World Religions Congress "Global Interfaith Harmony Education" on February 1-7, 2015 in Amman, under the UN aegis. It will be logical development of the HM World Interfaith Harmony Week initiative.

## Project Key Definition:

*The ABC of Harmony* is the second, after the internal harmonious potential of religions, necessary scientific and educational base for world interfaith harmony in the 21<sup>st</sup> century. *The ABC of Harmony* as world textbook provides global harmonious education, forming global harmonious consciousness as the most profound and sustainable spiritual foundation for interfaith harmony and harmonious civilization of the new century. It opens an entirely new, Interspiritual Revolution Age of world interfaith harmony.

## Project Overall Goal:

Dialogue and Creation in Different Faiths of the Interfaith Harmony Schools

## Project Purposes in 2013:

1. The Project debates in various religious denominations during the UN World Interfaith Harmony Week (UNWIHW): the first week of February, 2013 (<http://worldinterfaithharmonyweek.com/>)
2. In the event the Project will find recognition in any confession of any country, to start creating in it the first Interfaith Harmony School based on the ABC of Harmony in partnership with GHA.
3. Participation in the contest for the WIHW Prize:  
<http://worldinterfaithharmonyweek.com/world-interfaith-harmony-week-prize/>

GHA 42<sup>nd</sup> Project  
Started: December 7, 2012  
Approved in GHA: February 8, 2013

**Project Initiator, one of Authors and Editor in Chief is Dr. Leo Semashko and**

**More than 110 Participants of the GHA Project from 5 Continents, Including 35 Coauthors  
(38 articles and 2 poems) from 14 Confessions and of 17 Countries  
on February 24, 2013**

**The GHA World Interfaith Harmony Project Authors**

<b>Author's Name:</b>	<b>Faith:</b>	<b>Country:</b>
1. Celia Altschuler	Catholic	Puerto Rico
2. Ayo Ayoola-Amale.	Catholic	Ghana
3. Daurenbek Aubakir	Muslim	Kazakhstan
4. Reimon Bachika.	Shinto	Japan
5. Uraz Baimuratov.	Muslim	Kazakhstan
6. Ammar Banni.	Muslim	Algeria
7. Julia Budnikova.	Orthodox	Russia
8. Tholana A. Chakravarthy.	Hindu	India
9. Bruce L. Cook.	Catholic	USA
10. Robert D. Crane	Muslim	Qatar
11. Dmitry Delyukin.	Orthodox	Russia
12. Pravat K. Dhal.	Hindu	India
13. Michael Ellis.	Buddhist	Australia
14. Michael D. Greaney.	Catholic	USA
15. Kurt Johnson	Multifaith	USA
16. APJ Abdul Kalam.	Muslim	India
17. Tatomir Ion-Marius	Ecumenism	Romania
18. Glenn T. Martin.	Multifaith	USA
19. A. K. Merchant.	Bahá'í	India
20. Charles Mercieca.	Multifaith	USA
21. Nina Meyerhof.	Jewish	USA
22. Manijeh Navidnia.	Muslim	Iran
23. David R. Ord	Multifaith	USA
24. Abbas Panakkal	Muslim	India
25. Bishnu Pathak.	Hindu-Buddhist	Nepal
26. Steve V. Rajan.	Muslim	Malaysia
27. Maitreyee B. Roy.	Hindu	India
28. Leo Semashko.	Orthodox	Russia
29. Sunita Singh Sengupta	Hindu	India
30. Varant Z. Seropian.	Lebanese-Armenian Christian	Lebanon
31. Rudolf Siebert.	Catholic	USA
32. Yehuda Stolov.	Jewish	Israel
33. Laj Utreja.	Sanatana Dharma	USA
34. Rene Wadlow.	Liberal protestant	France
35. Chintamani Yogi	Hindu	Nepal
Faiths representatives: 1. Bahá'í – 1 2. Buddhist – 1 3. Catholic – 5 4. Ecumenism - 1 5. Hindu – 5 6. Hindu-Buddhist – 1 7. Jewish – 2		Algeria Australia France Ghana India Iran Israel Japan

<p>8. Lebanese-Armenian Christian – 1  9. Liberal protestant – 1  10. Multifaith – 3  11. Muslim – 5  12. Orthodox – 3  13. Sanatana Dharma – 1  14. Shinto – 1  - <b>All confessions are 14.</b></p>		<p>Kazakhstan  Lebanon  Malaysia  Nepal  Puerto Rico  Qatar  Romania  Russia  USA  - <b>All countries are 17</b></p>
---	--	--

The project is open to new participants on the basis of ideas and articles of interfaith harmony on the basis of *the ABC of Harmony* and similar books to join the authors and/or the public discussion through the GHA mailing list: [gha@freelists.org](mailto:gha@freelists.org) and on the GHA Forum (see below).

All project authors gave positive reviews of *the ABC of Harmony* that expresses their spiritual unity in the scientific understanding of the social and interfaith harmony in all their theoretical diversity (see the articles below). *The ABC of Harmony* as world textbook provides global harmonious education, forming global harmonious consciousness as the most profound and lasting scientific foundation for interfaith harmony and harmonious civilization of the 21<sup>st</sup> century. *The ABC of Harmony* reviews in Russian and English are available here:

[www.peacefromharmony.org/?cat=ru\\_c&key=534](http://www.peacefromharmony.org/?cat=ru_c&key=534)

[www.peacefromharmony.org/?cat=en\\_c&key=506](http://www.peacefromharmony.org/?cat=en_c&key=506)

© Global Harmony Association, 2012

© Leo M. Semashko, 2012

Published in languages:

English: [www.peacefromharmony.org/?cat=en\\_c&key=541](http://www.peacefromharmony.org/?cat=en_c&key=541)

Russian: [www.peacefromharmony.org/?cat=ru\\_c&key=563](http://www.peacefromharmony.org/?cat=ru_c&key=563)

PDF publication:

English: [www.peacefromharmony.org/docs/World\\_Interfaith\\_Harmony.pdf](http://www.peacefromharmony.org/docs/World_Interfaith_Harmony.pdf)

Russian: [www.peacefromharmony.org/docs/World\\_Interfaith\\_Harmony\\_rus.pdf](http://www.peacefromharmony.org/docs/World_Interfaith_Harmony_rus.pdf)

Project's Discussion on the GHA Forum:

English: [www.forum.peacefromharmony.org/viewtopic.php?f=2&t=2049](http://www.forum.peacefromharmony.org/viewtopic.php?f=2&t=2049)

Russian: [www.forum.peacefromharmony.org/viewtopic.php?f=3&t=2050](http://www.forum.peacefromharmony.org/viewtopic.php?f=3&t=2050)

Access to English Project via Smart Phone:

[www.articlesonpeace.com](http://www.articlesonpeace.com) (Interfaith)

# Contents

## PART I

1. The UN World Interfaith Harmony Week (WIHW) and its Initiator Jordan's King H.M. Abdullah II as the WORLD HARMONY CREATOR in GHA Qualification ...8
2. Harmony of Religions as Necessary Condition of Global Social Harmony and World Peace ...10
3. Facts of Interfaith Harmony ...11
  - APJ Abdul Kalam. The Great City of Harmony. Poem ...13
  - Dmitry Delyukin. Penang: Island of Interfaith Harmony ...14
  - Yehuda Stolov. Interfaith Harmony among Jews and Muslims in Jerusalem ...15
  - Reimon Bachika. Interfaith Harmony in Japan ...17
  - A.K. Merchant. Dialogue for Harmony, Diversity & Spirituality—the Baha'i Way ...18
  - Pravat K. Dhal. Sri Aurobindo's Teaching and Practice in the Interfaith Harmony ...23
  - Nina Meyerhof. Interfaith Harmony among the COE World Children ...26
  - Maitreyee B. Roy. Om Santi, Om Shanti, Om Shantih: Hindu Concepts of Eternal Peace and Harmony ...27
  - Ayo Ayoola-Amale. Interfaith Harmony in Nigeria ...29
  - Bruce L. Cook. Personal Examples of Interfaith Harmony ...32
  - Glenn T. Martin. on My Multi-faith Religious Experience ...33
  - Laj Utreja. Lifetime Achievements of Interfaith Mission Service in Huntsville, AL, USA ...34
  - Varant Z. Seropian. The Challenges to Interfaith Harmony in the Middle East and their Responses ...38
  - Chintamani Yogi. Interfaith Movement and Current Politics in Nepal ...40
  - Sunita Singh Sengupta. Living the Interfaith Harmony: Experiences of Sri Ramakrishna ...42
  - Daurenbek Aubakir. Archaic Syncretism of Harmony in the Ancient Religion of Tengri ...45
  - Tatomir Ion-Marius. Planting the Holy Thorn and Peace Pole in Glastonbury Town ...48
4. Internal Harmony Potential of Different Religions ...50
  - Tholana A. Chakravarthy. The Winds of Interfaith Harmony. Poem ...50
  - Bruce L. Cook. Religious Congress in Chicago in 1893 as the Beginning of Conscious Interfaith Harmony ...51
  - Rene Wadlow. The Faiths of the Past and the Challenges of the Future: The Start of Interfaith Efforts ...54
  - Rudolf Siebert. The Golden Rule of Religions and Interfaith Harmony ...56
  - Bishnu Pathak. Principles of Religious and Interfaith Harmony ...58
  - Julia Budnikova. Nicholas Roerich on Interfaith Harmony and Common Principles of Spiritual Teachings ...60
  - Leo Semashko. Dalai Lama: Need for Religious Harmony ...63
  - Rudolf Siebert. The Realization of Harmony in Religion, Philosophy, and Science ...64
  - Charles Mercieca. World Religions and Interfaith Harmony ...69
  - Glen T. Martin. Interfaith Harmony and the Earth Federation Movement ...70
  - Ammar Banni. Multiculturalism of Interfaith Harmony ...74
  - Uraz Baimuratov. Islamic Banking as Institution of World Interfaith Harmony and Harmonization of Consciousness ...75
  - Manijeh Navidnia. Interfaith harmony and societal security ...81
  - Steve V. Rajan. Inner Divine Meditation for Interfaith Harmony ...83
  - Celia Altschuler. Interfaith Meeting through Love and Education ...85
  - Abbas Panakkal. International Seminar on Interfaith Harmony & Tolerance. Malaysia ...87

5. Need for Common Scientific and Educational Platform for Interfaith Harmony: *The ABC of Harmony* ...90
  - Michael D. Greaney. Religion and the Interfaith Harmony for Harmonious Economy. Is Faith or Reason the Basis of Economic Justice and Global Harmony? ...91
  - Michael Ellis. Globalisation of Interfaith Harmony through the ABC of Harmony. Religion, Ecology and Globalisation in the 21<sup>st</sup> Century ...97
  - Kurt Johnson. The Interspiritual Age of Interfaith Harmony ...101
  - Leo Semashko. Intuitive Knowledge of Harmony in the God Doctrine of Brahma Kumaris and Harmony Science ...102
  - Kurt Johnson and David Robert Ord. Interfaith Harmony as Interspiritual Harmony in the 21<sup>st</sup> Century ...107
  - Robert D. Crane. Global Awakening: Toward the Interfaith Harmony of Global Ethics ...114
6. Alphabet of Social Harmony, Acceptable to All Faiths and Ensuring their Harmony ...118
7. Way of Interfaith Harmony: Harmonious Education through Interfaith Harmony Schools on *the ABC of Harmony* Basis ...119
8. Curriculum of the Interfaith Harmony Schools. Example: Harmony School in Jerusalem ...120
9. The GHA Offers to Jordan's King Abdullah II ...122

## PART II

10. Appendixes ...123
  - Appendix 1. Leo Semashko. Key content of the ABC of Harmony on 12 pages ...123
  - Appendix 2. Nicholas Roerich: 13 Paintings of the Interfaith Harmony Leaders ...135
  - Appendix 3. The Project Authors List with Brief Information ...142
  - Appendix 4. Responses on the Project during its Discussion within the UN Week of World Interfaith Harmony, February 1-7, 2013 and later ...150



# 1. The UN World Interfaith Harmony Week (WIHW) and its Initiator Jordan's King H.M. Abdullah II as the WORLD HARMONY CREATOR in GHA Qualification

In the United Nations on General Assembly, 23 November 2010, at the sixty-fifth session, a proposal by H.M. King Abdullah II of Jordan was adopted: Resolution: "**World Interfaith Harmony Week**".

The General Assembly, ...

Recognizing the imperative need for dialogue among different faiths and religions to enhance mutual understanding, harmony and cooperation among people,

Recalling with appreciation various global, regional and subregional initiatives on mutual understanding and interfaith harmony, including the Tripartite Forum on Interfaith Cooperation for Peace, and the initiative "A Common Word",

Recognizing that the moral imperatives of all religions, convictions and beliefs call for peace, tolerance and mutual understanding,

1. Reaffirms that mutual understanding and interreligious dialogue constitute important dimensions of a culture of peace;

2. Proclaims the first week of February every year the World Interfaith Harmony Week between all religions, faiths and beliefs;

3. Encourages all States to support, on a voluntary basis, the spread of the message of interfaith harmony and goodwill in the world's churches, mosques, synagogues, temples and other places of worship during that week, based on love of God and love of one's neighbour or on love of the good and love of one's neighbour, each according to their own religious traditions or convictions;

4. Requests the Secretary-General to keep the General Assembly informed of the implementation of the present resolution.

(Full text: [www.worldinterfaithharmonyweek.com/docs/UN-declaration-65-5-EN.pdf](http://www.worldinterfaithharmonyweek.com/docs/UN-declaration-65-5-EN.pdf))

Following is the full text of His Majesty King Abdullah's address at the Plenary Session of the 65<sup>th</sup> General Assembly of the United Nations in New York on September 26<sup>th</sup>, 2010 with the proposal of the World Interfaith Harmony Week: <http://worldinterfaithharmonyweek.com/newspost/h-m-king-abdullah-proposes-world-interfaith-harmony-week-at-the-un/>

In connection with this initiative, the Global Harmony Association (GHA), as a result of many days of discussion, recognized Jordan's King H.M. Abdullah II at the GHA High Honorary Title, **World Harmony Creator** with the following motivation:

For an unprecedented contribution to Global harmony, expressed in suggesting the United Nations Resolution "World Interfaith Harmony Week" adopted by the General Assembly, November 23, 2010.

This initiative of Jordan's King Abdullah II opened the way for global harmony through conscious world interfaith harmony, without which the development of a harmonious civilization is impossible. This makes the King of Jordan, one of the world's leaders of global harmony. His initiative deserves the GHA highest title as it coincides with the trend of global harmonious education and enlightenment on basis of the ABC of Harmony, created in GHA.

H.M. King Abdullah II of Jordan is included in the GHA Gallery: World Harmony Creators:

[http://peacefromharmony.org/?cat=en\\_c&key=513](http://peacefromharmony.org/?cat=en_c&key=513)

[http://peacefromharmony.org/?cat=ru\\_c&key=543](http://peacefromharmony.org/?cat=ru_c&key=543)

Approved by GHA, January 23, 2013

This Gallery also includes other prominent political leaders: President of India – APJ Abdul Kalam, President of Kazakhstan - Nursultan Nazarbayev, Prince of Wales, and a number of distinguished scientists who made a unique contribution to global harmony.

The Royal Aal Al-Bayt Institute for Islamic Thought in Jordan establishes annual WIHW Prize.

The Royal Aal Al-Bayt Institute for Islamic Thought in Jordan is delighted to announce the establishment of three WIHW Prizes. A prize will be given to each of the three best events or texts organized during the UN WIHW (first week of February) which best promote the goals of the WIHW.

The prizes will be:

First –\$25,000 and a gold medal

Second –\$15,000 and a silver medal

Third –\$5,000 and a bronze medal

The prizes will be awarded to those events or texts that are judged to have been most successful in promoting interfaith harmony, and impacting religious understanding.

Submission of Supporting Materials

To be considered for the prize, entries must submit the following:

- photos and / or videos from the event
- media reports about the event or text
- Testimonial(s) of Distinguished Guest(s) about event
- 3-5 references who can testify to qualifications of person/organization competing for the prize

(In more details here:

<http://worldinterfaithharmonyweek.com/world-interfaith-harmony-week-prize/>)

## 2. Harmony of Religions as Necessary Condition of Global Social Harmony and World Peace

The GHA long ago established the law of global harmony, according to which social harmony at any scale (harmonious civilization, world peace, every community and etc.) cannot exist without the harmony of religions and interfaith harmony. In a positive way, it says, social harmony at any level and scale requires religious, interfaith harmony. This law was discussed in different forms but in a single essence, in the GHA various projects and books from *Harmonious Era Calendar*, 2006:

[www.peacefromharmony.org/?cat=ru\\_c&key=190](http://www.peacefromharmony.org/?cat=ru_c&key=190).

Special development and basing the religious harmony through harmonious education is found in the Dr. Leo Semashko paper: *"General Harmonious Education as the Best Way for Harmonization of Relations between Religions"* in the **International Conference "Religion and Civil Society"**, Yalta, Ukraine, 20-22 November 2008:

[http://peacefromharmony.org/?cat=en\\_c&key=352](http://peacefromharmony.org/?cat=en_c&key=352).

For the time of the recurrent discussions of this law since 2006, we have not met any valid argument to refute it. At the same time, the details, forms and practice of its application caused and called many different discussions. This is natural, as the topic of religious harmony within global social harmony is an area of endless discussion.

The coauthors of the GHA project "Interfaith Harmony" recognize the law of social need for religious harmony as the immutable rule of global harmony and focus their attention not on the evidence but on the development of ways to achieve it and how to promote interfaith harmony. This is fully consistent with the objective of the World Interfaith Harmony Week of the UN, to which our project is dedicated.

### 3. Facts of Interfaith Harmony

The GHA, developing a scientific approach to global harmony, gives special attention to its facts ([www.peacefromharmony.org/?cat=en\\_c&key=382](http://www.peacefromharmony.org/?cat=en_c&key=382)). Here we only list the basic facts of religious (interfaith) harmony, which confirm the objective tendency of harmonizing relations among religions that is in the global trend toward religious and social harmony. These facts we capture only since the late 1950's: the previous period awaiting analysis.

#### **Facts interfaith harmony since the late 1950's:**

##### **In the social and political spheres:**

1. Israel, Interfaith Encounter Association (Interfaith dialogue) was established in Israel, Jerusalem in the late 1950's by a small group of visionaries: [www.interfaith-encounter.org](http://www.interfaith-encounter.org)
2. India (1968): Auroville Community based on the spiritual interfaith harmony and numbering about 2 thousand inhabitants; the founder is Mirra Alfassa, "Mother": [www.peacefromharmony.org/?cat=en\\_c&key=329](http://www.peacefromharmony.org/?cat=en_c&key=329),
3. Malaysia (1970): on the basis of the State Declaration of Five National Principles (Rukun Negara), Malaysia was converted into the racially balanced, socially stable, religious harmonious and prospering society: [http://en.wikipedia.org/wiki/Rukun\\_Negara](http://en.wikipedia.org/wiki/Rukun_Negara), <http://en.wikipedia.org/wiki/Malaysia>,
4. USA, California (1978): Annual National Harmony Festival on the interfaith base, the founder is Debra Giusti: [www.harmonyfestival.com](http://www.harmonyfestival.com),
5. Singapore (since 1997) provided harmony of interracial and interreligious relations: [http://en.wikipedia.org/wiki/Racial\\_Harmony\\_Day](http://en.wikipedia.org/wiki/Racial_Harmony_Day),
6. Singapore (2003): State Declaration of Religious Harmony as the first in history document of the conscious state policy of social harmony, founder: Goh Chok Tong: [http://en.wikipedia.org/wiki/Declaration\\_of\\_Religious\\_Harmony](http://en.wikipedia.org/wiki/Declaration_of_Religious_Harmony),
7. Kazakhstan (2003) declared itself as the centre for Eurasia harmonization, held the First International Conference of Peace and Harmony, on which has been accepted "Eurasian Charter of Peace and Harmony": [www.peacefromharmony.org/?cat=en\\_c&key=333](http://www.peacefromharmony.org/?cat=en_c&key=333),
8. China (2006) passed from dictatorship of the proletariat to 'building of a harmonious society', including interfaith harmony: [www.peacefromharmony.org/?cat=en\\_c&key=28](http://www.peacefromharmony.org/?cat=en_c&key=28),
9. Russia, St.-Petersburg (2006-2010), City Administration Program: "Tolerance: Great City Requires Harmony in Diversity" including interfaith harmony: [www.peacefromharmony.org/?cat=ru\\_c&key=345](http://www.peacefromharmony.org/?cat=ru_c&key=345), (in Russian),
10. Russia and West (2007): The Act of Canonical Communion with the Moscow Patriarchate reunited the two branches of the Russian Orthodox Church: the Russian Orthodox Church Outside Russia (ROCOR) and the Moscow Patriarchate as an appreciable step of religious harmonization: [http://en.wikipedia.org/wiki/Act\\_of\\_Canonical\\_Communion\\_with\\_the\\_Moscow\\_Patriarchate](http://en.wikipedia.org/wiki/Act_of_Canonical_Communion_with_the_Moscow_Patriarchate),
11. USA (June 2009): a policy of harmonization of relations with the Islamic world and transition from «clash of civilizations» to global harmony: [www.whitehouse.gov/blog/NewBeginning](http://www.whitehouse.gov/blog/NewBeginning),
12. The UN (2010): Resolution about World Interfaith Harmony Week: [www.worldinterfaithharmonyweek.com/docs/UN-declaration-65-5-EN.pdf](http://www.worldinterfaithharmonyweek.com/docs/UN-declaration-65-5-EN.pdf)

### In Culture and Science:

13. Understanding of the "Golden Rule of Religions" as the most ancient expression of social harmony: Rudolf Siebert, USA, 1980: [www.rudolfsiebert.org](http://www.rudolfsiebert.org),
14. Discovery of the sphere classes of the population as the actors of social and interfaith harmony: Leo Semashko, Russia, 1989: [www.peacefromharmony.org/?cat=en\\_c&key=180](http://www.peacefromharmony.org/?cat=en_c&key=180),
15. Idea of a Harmonious Peace Culture excluding war, including interfaith: Ada Aharoni, Israel, 2000: [www.peacefromharmony.org/?cat=en\\_c&key=2](http://www.peacefromharmony.org/?cat=en_c&key=2),
16. International bilingualism of English and Esperanto, as a way of linguistic and interfaith harmonization: Leo Semashko, Russia and Renato Corsetti, Italy, 2005: [www.peacefromharmony.org/?cat=en\\_c&key=97](http://www.peacefromharmony.org/?cat=en_c&key=97) and [www.peacefromharmony.org/?cat=en\\_c&key=107](http://www.peacefromharmony.org/?cat=en_c&key=107),
17. Pope Benedict XVI appeal: "to discover life meaning to the great cosmic harmony": Vatican 2006: [www.peacefromharmony.org/?cat=en\\_c&key=308](http://www.peacefromharmony.org/?cat=en_c&key=308), [www.vatican.va/holy\\_father/benedict\\_xvi/](http://www.vatican.va/holy_father/benedict_xvi/),
18. International Website "Peace from Harmony" uniting ideas of harmony from the entire world, including interfaith harmony and publishing in 17 languages, February 2005: [www.peacefromharmony.org](http://www.peacefromharmony.org),
19. Global Harmony Association as a World Community of global and interfaith harmony, de facto February 2005, de jure 2007: [http://peacefromharmony.org/?cat=en\\_c&key=249](http://peacefromharmony.org/?cat=en_c&key=249),
20. *Harmonious Era Calendar* of GHA as Calendar of interfaith harmony, January 2006: [www.peacefromharmony.org/?cat=ru\\_c&key=190](http://www.peacefromharmony.org/?cat=ru_c&key=190),
21. *Magna Carta of Harmony* of GHA as the Interfaith Charter, December 2006: [http://peacefromharmony.org/?cat=en\\_c&key=3](http://peacefromharmony.org/?cat=en_c&key=3),
22. *Harmonious Civilization* of GHA unfolding the base direction of interfaith harmony, 2009: [www.peacefromharmony.org/?cat=en\\_c&key=379](http://www.peacefromharmony.org/?cat=en_c&key=379),
23. *The GHA ABC of Harmony*, determining the fundamental basis for interfaith harmony and its achievements in global harmonious education, including any religious confession: [www.peacefromharmony.org/?cat=en\\_c&key=478](http://www.peacefromharmony.org/?cat=en_c&key=478).

Naturally, this list of social and cultural achievements of interfaith harmony is far from complete. It will be complemented by the new facts that will open in the history, or will emerge in modern times.

APJ Abdul Kalam

The Great City of Harmony

(Published: *The ABC of Harmony*, 2012, p. 266-267)

I heard Song of Unity in the streets  
Of harmony in the island!  
Ancient city of Penang  
I walked and walked every step,  
People of Malay, Muslims, Chinese, Christians  
Together walked with me with  
Pride and peace

The bell of St. George Church,  
Gave the glad tidings with a message,  
Forgive the human failing  
Give and give the hope of success.  
I entered the Kuan Yin temple  
With fragrance, the message radiating,  
Remove "I" and "Me"!  
That will eliminate human ego.

What a beautiful reception  
With a great music of  
Nadaswaram recital in the  
Sri Mahamariamman temple;  
The temple gave a message  
All places are our own, people of universe  
Are our kith and kin.  
The Teochew temple gave me a smile  
With a message 'if you remove "ego"  
Hatred will disappear;

In the great mosque participated in prayer  
With a Quranic recitation  
"Oh Almighty lead us the path of righteousness"  
The Yap Kongs, temple gave me  
The welcome song "eliminate hatred,  
Violence will disappear.  
In another temple Kho Kongs led us to the path  
Remove the violence in mind, peace in life will be filled with.

The Acheh Mosque gave us the message  
Message of removing the pain  
Of fellow human beings!  
This is Almighty's Command!

When I completed my pilgrimage  
The streets of Harmony of Penang.  
Presented an integrated spiritual centre  
With message to the Universe.  
Every human being will give and give  
The best of human societies will be born.

*Poem composed on 30<sup>th</sup> August 2008 on return from my tour of Penang-Malaysia. For visiting the various religious places in the street of harmony there were many cars, but seeing the large gathering of people, I walked with them to each place of worship.*

**Dr. APJ Abdul Kalam**, Muslim faith, b 1931, is one of the most distinguished scientists of India with the unique honour of receiving honorary doctorates from 42 Universities and institutions from India and abroad. Dr. Kalam became the 11<sup>th</sup> President of Republic of India on 25<sup>th</sup> July 2002. After five eventful years he demitted office on 25<sup>th</sup> July 2007.

The GHA Highest Honorary Title: WORLD HARMONY CREATOR:

[http://peacefromharmony.org/?cat=en\\_c&key=513](http://peacefromharmony.org/?cat=en_c&key=513)

Coauthor, *The ABC of Harmony*: [www.peacefromharmony.org/?cat=en\\_c&key=478](http://www.peacefromharmony.org/?cat=en_c&key=478)

**Address:** No 10, Rajaji marg, New Delhi-110011, India

**Phone:** 011 23793601

**Web:** [www.abdulkalam.com](http://www.abdulkalam.com), [www.peacefromharmony.org/?cat=en\\_c&key=95](http://www.peacefromharmony.org/?cat=en_c&key=95)

**E-mail:** [apj@abdulkalam.com](mailto:apj@abdulkalam.com)

Dmitry Delyukin

Penang: Island of Interfaith Harmony

(Published: *The ABC of Harmony*, 2012, p 148-149)

There is a unique place, called a street of Harmony in Penang, one of the island states in Malaysia. It is situated in the capital of the state, George Town, founded by the Englishmen, led by Captain Fransis Light in 1786. Being popular and famous among locals and guests of the island, the street could be officially named the street of Harmony, however it is still denoted as Pitt street in all the maps and guides. It is unique because this street is the only religious-cultural historical ensemble in the world, which has united architectural shrine masterpieces of all world religions. Mainly thanks to Pitt Street and its shrines the government of Malaysia has achieved recognition of Penang island as the object of cultural heritage of UNESCO.

Despite the fact, that Penang was all covered with the jungles, Captain Light decided to build fort Cornwalliss on the island and to start exploring the neighboring territories. Captain Light ordered everyone to spread the word all over Malaysia, so that every new settler will receive as much of the land, as he will be able to clean. Several years later there was a real town built instead of pathless jungles that was named George-Town after the king George III, with the town buildings in Victorian style. For the first 15 years of its existence the population of George Town has exceeded 10.000 people.

Generally, the chief inhabitants were the people with different cultural and religious formation. They all were united by the idea of finding work and welfare on this island defeated by the British empire, whereas their native counties suffered from different local and internal wars. Trade routes from Japan and China to Europe now ran through Penang. It was a strong push for development of the island and attraction of a great flow of immigrants from these countries, as well as from India, Middle East, Siam (Thailand), Myanmar, Sri-Lanka. In 1816 the first in the South-Eastern Asia English schools was opened in Penang, where children of all nations and estates of Penang population received education.

Naturally, today Malaysian is the main language of Penang, but at the beginning of the 21<sup>st</sup> century the English language became the main language of international communication. It was caused by the trade, organized by the European trade missions. However, the Asians didn't see anything bad in it. Fransis Light in the 1770-s, at the period of the town's beginning, first proclaimed not just the freedom of the settlements, but also the principle of religious freedom to maintain peaceful coexistence and order in Penang. The Englishmen set an example by building a majestic church in the Anglican style near the fort Cornwalliss, the first of this kind in the



South-Eastern Asia. Later all diasporas received the right and the land to build shrines corresponding to their denomination.

Not to divide the town in quarters, normally occurring by the nation's principle, special areas were provided for building, and these were later interconnected by Pitt street or Street of Harmony – an unofficial name, that appeared in the middle of the last century. It became a spiritual and public center, containing 9 main shrines of the town with all rich cultural heritage of Islamic, Buddhist, Confucian, Taoist, Hinduist, Sikh, Shinto and Christian communities, reflected in its architectural appearance, as well as the Armenian and Jewish communities, that soon left the island. The real pearls of the street are believed to be the church of Saint George, the Assumption Cathedral, the mosque Captain Kelling, the shrine Nagor, the shrine Tua Pek Kong, the shrine Guan In Teng, and the shrine Leon Sang Tong. They all were constructed in the first middle of the 21<sup>st</sup> century.

It is known, that the architecture of the shrines is the most important means of gradual formation of the attitude to life as a whole as to the divine creature and it reconstructs the harmony of the internal and external being. Step by step, by the beginning of 20<sup>th</sup> century a new form of public consciousness appeared sporadically, that after independence of Malaysia in 1957 resulted in the official ideology – "Rukunegara" or "The Foundations of the State", in view of the fact, that it included dozens thousands of representatives of different religious outlooks and traditions.

It may be assumed with certainty, that spiritual pluralism and harmony of religious diversity of Penang have become the way of living for its inhabitants. This is an excellent example for all the regions of religious conflicts. Such examples will become the ABC for the global harmonious civilization. At the moment, such sporadic examples are exotic for industrialism. To make them universal, they must be conscious – that is the goal of *the ABC of Harmony* and based on it the global harmonious education of believers of all faiths.

**Dmitry V. Delukin**, Orthodox Faith.

He has graduated from the Philology faculty of Saint-Petersburg State University in 1994. Now is the employee of Saint-Petersburg State Museum-institute of Roerich family. Coauthor, *The ABC of Harmony*: [www.peacefromharmony.org/?cat=en\\_c&key=478](http://www.peacefromharmony.org/?cat=en_c&key=478).

**Address:** Saint-Petersburg, Russia

**E-mail:** [dimdel10@yandex.ru](mailto:dimdel10@yandex.ru)

Yehuda Stolov

Interfaith Harmony among Jews and Muslims in Jerusalem

(Published: *The ABC of Harmony*, 2012, p. 150-151)

The Interfaith Encounter Association (IEA) was formed in the summer of 2001 and works since to promote genuine coexistence and sustainable peace, through joint community building on the grassroots level, using interactive interfaith dialogue as its vehicle. The a-political and all-inclusive approach of the organization and its activities continuously form the human infrastructure for peace in the Holy Land.

In its ten years of existence, the IEA have held – in its three regional focuses: in Israel, between Israelis and Palestinians and in the larger Middle East – more than 1000 programs, with thousands of participants. A most significant fact is that the participants in IEA programs include people of all political and religious views, as well as all ages, genders, walks of life etc; and that the vast majority of them have met 'the other' for the first time through IEA. The IEA have formed till now 41 on-going community-groups of interfaith encounter – from the Upper Galilee to Eilat, including 10 groups that bring together on a regular basis Israelis and West Bank Palestinians. Among the latter we maintain the three only groups in the country that bring together Palestinians with Settlers.



IEA maintains working relations with 7 Palestinian organizations, across the West Bank and the Gaza Strip and is a founding partner of the Middle East Abrahamic Forum, including Egypt, Iran, Jordan, Lebanon, Morocco, Tunisia and Turkey.

In 2010, IEA sponsored 165 encounters and events of various interfaith groups. Sixty of these encounters involved children, youth, and university students. Cumulatively, over 4,000 people attended its groups in 2010, many taking part on a regular basis. The IEA sponsor groups meeting both within the "Green Line" and in the West Bank, providing safe spaces for respectful discussions of issues relating to participants' religious beliefs. It is through these meetings, discussions, and time spent together that warm and understanding relationships are built and maintained among people of different faiths, cultures, and communities.

Beyond the groups' regular work, IEA had in the last year new areas of activity:

- For the first time since the beginning of the Second Intifada's violence, our Jerusalem-Hebron Youth Interfaith Encounter held a joint encounter and visit to the Palestinian-controlled part of Hebron. We were the first Israeli group to enter these parts of Hebron with permission from the army. The same group is organizing an encounter in Tel Aviv-Jaffa, enabling its Palestinian members to visit the sea for the first time in ten years (for some it will be their first time!)
- The "Circle of Light and Hope" Israeli-Palestinian Interfaith Encounter group organized a historic visit of Palestinian Muslims to the Friday night services of the (Orthodox) Kehilat Yedidya Synagogue in Jerusalem.
- The coordinators of the "A/Nahnu" Youth Interfaith Encounter in the Mt. Scopus campus of the Hebrew University obtained the agreement of the university's authorities to open a Muslim Prayer Room on campus. Furthermore, the intention is to make this room as the center for interfaith encounter activity.
- The coordinators of the group of Students from Hebrew University and Bethlehem University initiated a joint Israeli-Palestinian business venture for fair-trade marketing of olive oil, for funding activities of interfaith encounter.
- IEA began cooperating with the Feuerstein Institute in Jerusalem in bringing Palestinian children from Hebron and Gaza, who suffer from different forms of brain damage, for treatment and training at the Feuerstein Institute.
- With the additional support of the Anna Lindh Foundation, we initiated a major new project, the Euro-Mediterranean Abrahamic Forum. The first meeting took place in Amman with over 60 participants from seven Middle Eastern and five European countries, and was tremendously successful. The second one took place in Lublin, Poland in May 2011, and included a joint historical visit of such a mixed group to the nearby Majdanek Death Camp.

For its work the IEA has been recognized by UNESCO as "an organization that promotes the culture of peace" and awarded the 2006 Prize for Humanity by the Immortal Chaplains Foundation. In 2007 Two of IEA's coordinators won the Women's Peace Initiative Award of the Tanenbaum Center for Interreligious Understanding and the IEA was the recipient of the 2007 INTRA-Project Award for the Complementation of Religions of The Institute for Interreligious Studies. The film "Interfaith Encounter in the Galilee", produced by IEA to present the work of its school-twinning project, was awarded the Commendable Effort by the World Peace Film Award 2007 of the World Movement for Global Democracy. In May 2008, the IEA was one of the sixty projects, selected as "the entrepreneurial projects that will change the face of Tomorrow" to present at the Israeli Presidential Conference.

The IEA experience is very important for the conscious building of peace from harmony in the world on the basis of interfaith harmony.

**Yehuda Stolov.** Jewish faith. He is the executive director of the Interfaith Encounter Association, an organization that works to build peaceful inter-communal relations in the Holy Land by fostering mutual respect and trust through active interfaith dialogue. Dr. Stolov has

lectured on the role of religious dialogue in peace-building throughout the world. He holds a B.Sc. and an M.Sc. in Physics and a Ph.D. from the Hebrew University of Jerusalem. Coauthor, *The ABC of Harmony*: [www.peacefromharmony.org/?cat=en\\_c&key=478](http://www.peacefromharmony.org/?cat=en_c&key=478).  
**Address:** P.O. Box 3814, Jerusalem 91037, Israel  
**Web:** [www.interfaith-encounter.org](http://www.interfaith-encounter.org)  
**E-mail:** [yehuda@interfaith-encounter.org](mailto:yehuda@interfaith-encounter.org)

Reimon Bachika

### Interfaith Harmony in Japan

(Published: *The ABC of Harmony*, 2012, p. 146-147)

Religiously, Japan's situation resembles its natural existence as an island nation. Four islands, considerable in size and flanked by many smaller ones, constitute the country. Similarly, four different sources have contributed to Japan's religious culture: Shinto, Buddhism, Taoism, and Confucianism. The Shinto tradition is *culturally* the more influential strand of religion. It underwent some influence from Chinese Taoism, particularly *yang* and *yin* thought and fortune telling. Buddhism is *religiously* the stronger part. It was transmitted from Chinese sources but developed several varieties of Japanese Buddhism. Lastly, Confucian ideas impacted social relations as well as so-called ancestor worship.

Religious harmony exists on the level of everyday life. Remarkably, only one third of the population has membership in one of over two hundred religious denominations. Nevertheless, many Japanese feel attracted to religious customs of various kinds. Most of them worship at a Shinto shrine at New Years, when the whole country enjoys a week of holydays. At other occasions, parents take their children to a local shrine to pray for them at birth and at the ages of three, five, and seven. Further, many marriages are blessed in a Shinto ritual, but many others tie the knot at a Christian church or at chapels specially built for weddings. From December 20 or so, special decoration Christmas cakes are sold at stalls outside shops, just for casual passersby – only 1% of the Japanese have converted to Christianity (Catholicism or Protestantism) but it is a well respected religion. Quite different, when death strikes in a family, the Japanese turn to a Buddhist denominations for funeral rites. Remarkably again, the greater part of the population has either a Buddhist or a Shinto altar at home, to memorize deceased family members by offering flowers or fruits or incense. It is this practice that is called ancestor worship. Although Shinto and Buddhism have a distinct religious culture, 'household religion' functions as a common denominator.

The following are organizational religious practices. As mentioned above, the main event of Shinto is the New Year worship, starting at midnight at New Year's Eve. The most famous shrines draw enormous crowds of worshippers. At various occasions during the year, popular Shinto shrines provide occasion for worship, offering a simple ritual of purification that is performed on request, while neighborhood communities organize celebrations (*matsuri*), one more kind of Shinto practice. Apart from the funeral services provided by their priests Buddhist denominations are socially active in the field of education as well as welfare. Most of them have institutions of higher learning. Some temples are classified cultural treasures, open to the public at a fee. It is from all these services that Buddhist denominations derive their income.

The main traditional Buddhist denominations are as follows. Tendai and Shingon Buddhism were established in the Heian Period (794–1185) and followed by the Pure Land Denomination and Shin Buddhism (both known as Amida Buddhism) as well as the Nichiren denomination and two strands of Zen monasteries: Rinzai and Soto Zen, all of which originated in The Kamakura Period (1185–1333) in central Japan, with Kyoto as its center. All have their own revered founders and sutras. Based on these sacred scriptures they continue developing Buddhist religious thought.

Further we have the so-called 'the New Religions' that originated in the middle of the 19<sup>th</sup> century, the most active of which are Tenri-kyo and Konko-kyo (Shinto related denominations) and Soka Gakkai and Risshokoseikai (Buddhist denominations that grew fast after World War II). A few more sprang up in the 1970s, such as the infamous Omu Shinri-kyo and The Science of Happiness. The latter is following the example of Soka Gakkai in forming a political party, but as yet it is not very successful. In more details see: [121; 122].

Organized religion in Japan is pragmatic and can be characterized as 'corporate religion.' Like most business organizations, all manage their own affairs, competing with each other. Authoritarian attitudes are rare. The people's religious practices are uncomplicated. The meaning of these customs and practices is internalized through participation from childhood on and therefore taken for granted.

Thus, accommodating attitudes both by the people and the religious denominations make harmonious coexistence possible. At bottom, religion concerns the basic problems of life as well as spirituality that people can freely aspire to. Religious organizations are useful in providing services, spiritual guidance, and cultivating a special sense of community not found elsewhere. It is these conditions that render religious harmony possible, not top-down authoritarian thought.

Thus, the situation of religion in Japan is highly complex. Notwithstanding, we can say that it is "culturally" harmonious. In other words, Japanese culture is disposed to communitarian and interfaith harmony. The same should be possible for world civilization as a whole. Emphatically, civilization cannot be harmonious without a sense of harmony among world religions.

**Reimon Bachika**, Shinto faith,

Professor Emeritus (Dept Sociology) Bukkyo University, Kyoto, Japan. He is one of founders of the GHA.

Coauthor, *The ABC of Harmony*: [www.peacefromharmony.org/?cat=en\\_c&key=478](http://www.peacefromharmony.org/?cat=en_c&key=478).

**Address:** Yamamotodori 3-3-10 6F., Chuo-ku, KOBE, 650-0003 Japan

**Web:** [www.peacefromharmony.org/?cat=en\\_c&key=24](http://www.peacefromharmony.org/?cat=en_c&key=24)

**E-mail:** [rbac05yamk@yahoo.co.jp](mailto:rbac05yamk@yahoo.co.jp)

A. K. Merchant

## Dialogue for Harmony, Diversity & Spirituality — the Baha'i Way

Religion plays an important role in how we understand time – both the linear time of history and the cyclical times of social and spiritual events. In that sense history is still, according the Bahá'í writings, an unsatisfactory record of human progress. It is a calendar of the days that are past. It takes you through a silent avenue of tombs. It tells you stories of the battles fought and the empires carved by men and women. It is a poor record of the struggles that took place in the souls of those whose achievements adorn its pages. Other landmarks that regulate history and remained in the memory of human time are natural calamities such as pestilence, famine, drought, earthquakes, floods, volcanic eruptions, cataclysmic events, *inter alia*.

“The fundamental purpose animating the Faith of God and His Religion”, declared Bahá'u'lláh, “is to safeguard the interests and promote the unity of the human race, and to foster the spirit of love and fellowship amongst men. Suffer it not to become a source of dissension and discord, of hate and enmity. This is the straight Path, the fixed and immovable foundation. Whatsoever is raised on this foundation, the changes and chances of the world can never impair its strength nor will the revolution of countless centuries undermine its structure.” [1]

For most people in today's world, religion or dharma is not understood in such a straightforward manner. The ancient legacy of dharma, or religion handed down by our forefathers has become a heady brew of meaningless traditions, pseudo-spirituality, superstitions, rituals and dogma. So much so that the positive qualities of this powerful civilizing agent has

been reduced to belief in cultic practices and blind faith in charismatic god men and god women who have come to hold sway on the belief systems of countless millions – from the illiterate masses to the sophisticated and famous men and women in every country of the world. In such a setting India is blessed by an extraordinary multiplicity in linguistic, ethnic and cultural fields with an even more complex interplay of different religions and has also been looked upon as a showcase of tolerance and assimilation, for behind the obvious diversity there is an unending unity which is the greatest feature of our civilizational ethos. Satyamayve Jayte (Let Truth Prevail). India's legacy of the inter-faith dialogue and inter-religious parleys dates back to the days of emperor Ashoka and found culmination in the addresses of Swami Vivekananda in the first Parliament of the World's Religions in 1893.

Civilization, as we know it, is very ancient and as our first Prime Minister Jawaharlal Nehru wrote: "We might say that the first great cultural synthesis and fusion took place between the incoming Aryans and the Dravidians, who were probably the representatives of the Indus Valley civilization. Out of this synthesis and fusion grew the Indian races and the basic Indian culture, which had distinct elements of both. In the ages that followed there came many other races: Iranians, Greeks, Parthians, Bactrians, Scythians, Huns, Turks or Turks (before Islam), early Christians, Jews, Zoroastrians. They made difference and were absorbed. 'India was', according to Dodwell 'infinitely absorbent like the oceans.'"[2]

In the perspective of Bahá'u'lláh's teachings, the greatest danger of both the moral crisis and the inequities associated with globalization in its current form is an entrenched philosophical attitude that seeks to justify and excuse these failures. The overthrow of the twentieth century's totalitarian systems has not meant the end of ideology. on the contrary, there has not been a society in the history of the world, no matter how pragmatic, experimentalist and multi-form it may have been, that did not derive its thrust from some foundational interpretation of reality. Such a system of thought reigns today virtually unchallenged across the planet, under the nominal designation "Western civilization". Philosophically and politically, it presents itself as a kind of liberal relativism, economically and socially, as capitalism — two value systems that have now so adjusted to each other and become so mutually reinforcing as to constitute virtually a single, comprehensive worldview.[3]

The contribution of religion towards capacity building and promoting the peace process has in part been undervalued owing to the negative image it has acquired as a result of the history of conflicts in which religion has been seen to play a considerable role. The turmoil of the age has forced one scholar, Cantwell Smith, to write: "It is no longer possible to understand each 'religion' as a stable system." [4] The interconnectedness of man's religious history, as well as the convergence of 21<sup>st</sup> century humanity into one community, make it desirable to speak of one history of religion. "It is not the case that all religions are the same, however. They have grown up and developed in different times and at different places and represent and have represented many varieties of responses to the sense of the transcendent. Yet there is a continuum which is the historical process in which these different faith traditions have operated."[5]

Therefore, in order to enable every man, woman, youth and child to fulfill their highest potential an educational system has been conceived by the worldwide Baha'i community known as the "Ruhi Institute". The titles of the books as developed by this Institute are by themselves quite illustrative of the range and breadth of the subjects covered namely Reflections on the Life of the Spirit; Arising to Serve; Teaching Children's Classes, Grades I, II & III; The Twin Manifestations; Spiritual Empowerment of the Junior Youth [27 books] some of these are: Glimmerings of Hope, Learning About Excellence, Spirit of Faith, Breezes of Confirmation, Drawing on the Power of the Word, The Human Temple, [inter alia]; Planning & Teaching the Divine Cause; Walking Together on a Path of Service; Family Prosperity, and the like.[6]

The curricula offer an understanding of problems of present-day society at three levels of comprehension. The first is a basic understanding of the meaning of words and sentences of passages from the Holy Texts, which constitute the core of these courses. Thus, for example,

after reading the quotation, “The betterment of the world can be accomplished through pure and goodly deeds through commendable and seemly conduct”, [7] the participant is asked, “How can the betterment of the world be accomplished?” At first glance, this type of question may appear too simple. But the actual experience points to some of the reasons for the adoption of a simple approach to this basic level of understanding. The second level of comprehension is concerned with applying some of the concepts in the quotations to one’s daily life. And the third level of understanding requires the participants to think about the implications of the quotations for situations with no apparent or immediate connection with the theme of the quotation.

Many years of experience with the study and practical application of the guidance offered in these materials has demonstrated that examining ideas at these three levels of understanding helps collaborators create a conscious basis of a life of service to humanity and making each participant an agent of positive change for the building of a never-advancing civilization. In fact, the above system of education allows for the almost infinite development by various user communities of branching subsets that serve particular needs.

Moreover, the operation of the institute board; the functioning of coordinators at different levels; the capabilities of friends serving as tutors of study circles, animators of junior youth groups; teachers of children’s classes; and the promotion of an environment conducive at once to universal participation and mutual support and assistance have evolved over time and are being continually improved upon and refined. Of particular significance are the pedagogical principles governing the curriculum: developing capacity in every man, woman, youth and child to serve humanity in the light of Divine purpose in this Age of the “planetization of humankind” [8] “The process may be likened to walking a path of service. This conception shapes both content and structure. The very notion of a path is, itself, indicative of the nature and purpose of the courses, for a path invites participation, it beckons to new horizons, it demands effort and movement, it accommodates different paces and strides, it is structured and defined. A path can be experienced and known, not only by one or two but by scores upon scores; it belongs to the community.

To walk a path is a concept equally expressive. It requires of the individual volition and choice; it calls for a set of skills and abilities but also elicits certain qualities and attitudes; it necessitates a logical progression but admits, when needed, related lines of exploration; it may seem easy at the outset but becomes more challenging further along. And crucially, one walks the path in the company of others.” [9]

Over the past thirty plus years thousands of Bahá’í communities — from hamlets, villages and towns, to cities and megalopolis — are increasingly advancing the system of learning and attracting millions to experience the joy of building a new world. The work advancing in every corner of the globe today represents the latest stage of the ongoing Bahá’í endeavour to create the nucleus of the glorious civilization prophesied in the sacred scriptures of all the extant religions. Baha’is understand well that building of such an enterprise of infinite complexity and scale will demand centuries of exertion by humanity to bring to fruition.

For, the growing interdependence and the intensifying interaction among diverse peoples pose fundamental challenges to old ways of thinking, believing and acting. How we, as individuals and communities, respond to these challenges will, to a large degree, determine whether our communities become nurturing, cohesive and progressive, or inhospitable, divided and unsustainable? “To build a new world is no easy task. The road is stony and filled with obstacles, but the journey is infinitely rewarding.” [10]

Humanity’s crying needs will not be met by a struggle among competing ambitions or by protest against one or another of the countless wrongs afflicting a desperate age. It calls, rather, for a fundamental change of consciousness. The time has come when each human being on earth must learn to accept responsibility for the welfare of the entire human family. “The world is being made new. Death pangs are yielding to birth pangs. The pain shall pass when members of the human race act upon the common recognition of their essential oneness. There is light at the end of this tunnel of change beckoning humanity to the goal destined for it according to the

testimonies recorded in all the Holy Books.”[11] The internalization of the basic human values could serve as foundational blocks to the profound changes we are all experiencing.

Bahá'u'lláh speaks of two distinct but simultaneous and mutually reinforcing processes: one leading to the spiritual unity of the human race, that he refers to as the “Most Great Peace”; the other to the political unity of nations and described as the “Lesser Peace”. The former is a distant goal, requiring a monumental change in human conduct that only religious faith can ensure; the other is more immediate and can already be detected on the political horizon.

The horrific experiences of wars in the history of humankind and the resultant two world wars gave us the League of Nations and the United Nations respectively; the frequency with which world leaders, particularly with the ending of the Cold War and the rise of international terrorism, have met and debated on global issues; the renewed call for a global order that issued from the leaders at the Millennium Summits in 2000; the multiplication of organizations of civil society that focus attention on a variety of international concerns through the operation of an ever-expanding network of activities; the widespread debates on the need for global governance and numerous organized efforts towards world peace; the emergence of international tribunals; the rapid developments in communications technology that have made the planet borderless – these are among the voluminous evidences of an accelerating momentum to wage peace despite ominous signs of war.

Ostensibly, the movement leading to world unity must encounter opposing tendencies rooted in stubborn habits of chauvinism and partisanship that refuse to yield to the expectations of a new age. The torturous suffering imposed by such conditions as poverty, war, violence, fanaticism, disease, and degradation of the environment, to which masses of people are subjected, is a consequence of this opposition. Hence, before the peace of nations matures into a comprehensive reality, it must pass through difficult stages, not unlike those experienced by individual nations until their internal consolidation was achieved. “Be anxiously concerned with the needs of the age ye live in and centre your deliberations on its exigencies and requirements.” [12] “The world is in travail, and its agitation waxeth day by day”, is Bahá'u'lláh warning. “Its face is turned towards waywardness and unbelief. Such shall be its plight, that to disclose it now would not be meet and seemly. Its perversity will long continue. And when the appointed hour is come, there shall suddenly appear that which shall cause the limbs of mankind to quake...” [13]

Earthmen landing on the moon have perceived what poets, philosophers, and prophets have proclaimed through the centuries — the oneness of the human family. At a time when there is talk of setting up a base on the moon let us recall what one astronaut reported: “The view of the earth from the moon fascinated me — a small disk, 240,000 miles away. It was hard to think that that little thing held so many problems, so many frustrations. Raging nationalistic interests, famines, wars, pestilence don't show from that distance. I'm convinced that some wayward stranger in a spacecraft, coming from another part of the heavens, could look at earth and never know that it was inhabited at all. But the same wayward stranger would certainly know instinctively that if the earth were inhabited, then the destinies of all who lived on it must be inevitably interwoven and joined. We are one hunk of ground, water, air, clouds, floating around in space. From out there it really is one world.”[14] “Consort with the followers of all religions,” Bahá'u'lláh appeals to all, “in a spirit of friendliness and fellowship.”[15] And again: “It is not his to boast who loveth his country, but is his who loveth the world.”[16] His vision of humanity as one people and of the earth as our common homeland, enunciated over one-hundred forty years ago, was dismissed out of hand by the world leaders to whom he first addressed his mission. But today it has become the focus of human hope, more so with the ecological and environmental disasters that could well decide the fate of entire humankind.

Bahá'u'lláh addressing humankind more than a century ago said: “Ye are the fruits of one tree and the leaves of one branch.”[17] He compares humanity to a tree. The people of various races, castes, religions and cultural backgrounds are all like the branches and leaves of the same tree. The roots of this tree should be firmly fixed onto the spiritual principles that are the basis



for values and morality and for living in harmony with each other. “Peerless is this Day, for it is as the eye to past ages and centuries, and as a light unto the darkness of the times.”[18]

Ideas of Baha'u'llah about harmonious unity of the nations and religions are finding application and development in the scientific *ABC of Harmony* by 76 coauthors of the GHA from 26 countries: [www.peacefromharmony.org/?cat=en\\_c&key=478](http://www.peacefromharmony.org/?cat=en_c&key=478). This global textbook deepens understanding of global harmonious civilization of the 21<sup>st</sup> century and the way to it through the global harmonious education, based on this ABC and all the Sacred Scriptures.

### References & Bibliography

1. Baha'u'llah. Gleanings from the Writings of Baha'u'llah. (New Delhi: Baha'i Publishing Trust of India, 1973), section CX, p. 215.
2. Nehru, J. L. The Discovery of India. (Bombay: Asia Publishing House, 1961, repr. 1967), p. 76.
3. Cf. Baha'i World Centre. The Century of Light. (New Delhi: Baha'i Publishing Trust of India, 2001), p. 135.
4. Smith. Cantwell. Quoted in S. Bushrui, The Spiritual Heritage of Humankind, lecture notes, Landegg International Academy, 1991-92, p. 24.
5. Ibid., 25.
6. These materials are available from the Baha'i Publishing Trust of India, F3/6, Okhla Industrial Estate, New Delhi 110 020. Website: [www.bahaindia.in](http://www.bahaindia.in)
7. Baha'u'llah. Quoted in Shoghi Effendi, The Advent of Divine Justice. (New Delhi: Baha'i Publishing Trust of India, 1969), p. 25.
8. A phrase coined by the famous Jesuit theologian and philosopher, Pierre Teilhard de Chardin.
9. The Universal House of Justice letter addressed to National Spiritual Assemblies dated 12<sup>th</sup> December 2011 (unpublished).
10. The Universal House of Justice letter dated 9<sup>th</sup> November 1993, published in Promoting Entry by Troops. (New Delhi: Baha'i Publishing Trust of India, 1993), p. 3.
11. The Universal House of Justice letter dated 23<sup>rd</sup> May 2001 published in The Baha'i Year Book – 1992-93. (Oxford: Baha'i World Centre publications, 1993), p. 43.
12. Baha'u'llah. Gleanings, op. cit. Section CVI, p. 286.
13. Ibid., section LXI, pp. 118-119.
14. Fersh, Seymour. Editor, Learning About Peoples and Cultures, “Our Place on Earth.” (Canada, Agincourt: The Book Society of Canada Limited), p. 17.
15. Baha'u'llah. Gleanings, op. cit. Section CXXXII, p. 289.
16. Ibid., section CXVII, p. 250.
17. Ibid., section CXXXII, p. 288.
18. Baha'u'llah. Quoted in Shoghi Effendi, The Advent of Divine Justice, op cit. p. 69.

**Dr. A. K. Merchant**, Bahá'í Faith,

Vice-President, Global Harmony Association.

The author is the General Secretary, The Temple of Understanding — India [NGO with consultative status at the United Nations]; National Trustee, Lotus Temple & the Baha'i Community of India. He also serves as Chairperson, Sarvodaya International Trust — Delhi Chapter; Associate Secretary General, Global Warming Reduction Centre; Visiting Faculty, Centre for Cultural Resources & Training, Government of India; Member, Ethics Committee, Ram Manohar Lohia Hospital; subject expert for interfaith harmony & Indian culture, Jawaharlal Memorial Fund.

Dr. Merchant is the author of three monographs:

*Communal Harmony — India's Greatest Challenge* (1991);

*Hindu Dharama evam Bahá'í Dharma — Ek Adhayyan* (1999);

*Five Basic Human Values & the Bahá'í Faith* (2009),

and 200 research articles and papers published in international and national journals and as book chapters.

Although ancestry wise from Gujarat, he was born in Myanmar and spent his early childhood over there. He is a member of the Bahá'í community since 1975 and has travelled to some 35 countries and lived in different parts of India — West Bengal, Goa, Tamil Nadu, Karnataka, Jharkhand, Uttar Pradesh, Maharashtra, Jammu & Kashmir; for the last 28 years in Delhi.

**Mailing address:** S – 28, Greater Kailash Part I, New Delhi 110 048, India.

**Phones:** 011-29237919 / 9810441360

**E-mail:** [akmerchant@hotmail.com](mailto:akmerchant@hotmail.com), [ak9merchant@gmail.com](mailto:ak9merchant@gmail.com)

19/01/13

Pravat K. Dhal

## Sri Aurobindo's Teaching and Practice in the Interfaith Harmony

**Introduction.** Sri Aurobindo(1872-1950) was a yogi, poet, mystic, philosopher, and most importantly the pre-eminent Indian spiritual teacher of the 20<sup>th</sup> century. The Mother, who was his complete spiritual collaborator, created and organized the Sri Aurobindo Ashram and Auroville. Sri Aurobindo wanted a radical change of the world. Hence, He spent fifty years in 'Tapasya' (sadhana) and descended the transformational force to the earth, i.e. 'Supramental'. Integral education is the practical aspect of his ideas, which is implemented throughout the world for transformation of the society.

**Sri Aurobindo's Education.** Regarding this, The Mother (26<sup>th</sup> July, 1965) said, "*India has or rather had the knowledge of the spirit, but she neglected matter and suffered for it. The west has the knowledge of matter but rejected the spirit and suffers badly for it. An integral education which could, with some variations, be adapted to all the nations of the world must bring back the legitimate authority of the spirit over matter fully developed and utilized*" [1].

Sri Aurobindo's concept of education has blended the oriental and western culture, spiritual and material values and science and Vedanta. This much professed Integral education must emphasize the Psychic and Spiritual aspects in addition to the Physical, Mental and Vital aspects as denoted by Spirit and Matter respectively. The cultivation of these aspects Beauty, Power, Knowledge, Love and Bliss is what he calls as Integral education. Beauty is to be realized through physical culture. Power is to be achieved through cultivation of vital being. Knowledge will obtain through mental education. Love is the formation of desirable feelings and emotions which should be directed towards others and the communion with the Divine. This is the result of Psychic education. The cultivation of spiritual aspects will provide Bliss or 'Anand'. According to him, the evolution of consciousness does not end with mind, but it extends to greater levels, namely, higher mind, illumined mind, intuitive mind, over mind and super mind. These levels evolve from man to superman and lastly to 'Satchidanda'. All kinds of curricular and co-curricular activities should aim at inculcating spiritual and psychic values like love, truth, faith in God, competency in performance strength of mind and heart. International understanding, Universal love, sympathy, fellow feeling and mutual understanding are the desirable characteristics to be developed among children.

Integral education integrates the inner and outer realities of life. It believes in harmony and synthesis. It leads individual, social and universal development. It draws at a world unifying consciousness that spreads towards the greater harmonies of being, individually, socially, geopolitically. 'Auroville' is a unique example of this. In this system there must be balance and harmony in the individual and in the society

**Human Unity and International Understanding in Integral Education.** The foundation of integral education is meant for the whole world. This leads to the unity of all nations, international understanding and interfaith harmony. According to The Mother, "*unity of*



*the human race can be achieved neither by uniformity nor by domination and subjection, but by a synthetic organisation of all nations, each one occupying its true place according to its own genius and the part it has to play in the whole. In order to make this synthesis a living one, the grouping should be effectuated around a central idea that is as wide and as high as possible, in which all tendencies, even the most contradictory, may find their respective places. Education has a positive role to play in bring world union by making the children accustomed from a very early age not merely to the idea itself, but to its practice” [2].* Sri Aurobindo International Centre of Education at Pondicherry is a step towards the achievement of this ideal. The attempts of Sri Aurobindo and The Mother to educate people for human unity and international understanding include the creation of Auroville - a city of the future humanity which has spiritual principle as its base. It is observed that the world trends in education are moving towards that.

**Auroville.** Greetings from Auroville to all men of good will and are invited to Auroville - all those who thirst for progress and aspire to a higher and truer life. Auroville wants to be a universal town where men and women of all countries will be able to live in peace and progressive harmony, above all creeds, all politics and all nationalities. The aim of Auroville is to realize Human Unity [3].

Auroville, the City of Dawn, is a place in south India where, for more than thirty years, an increasing number of people from all over the world and of all faiths have been quietly and painstakingly working on the construction of a new township, a new way of living, a new way of being. Something is being attempted here for the benefit of all.

Auroville is to be a major vehicle of this evolutionary thrust and, eventually, a platform for transformation. Auroville is a collective experiment dedicated to human unity and international understanding. Auroville is intended as a city for up to 50,000 inhabitants. Today its number of inhabitants is around 2,000 people, drawn from some forty four nations and tens of religions. They live in about 100 settlements of varying size, separated by village and temple lands and surrounded by Tamil villages with a total population of over 35,000 people.

Since the very beginning, Auroville has received the unanimous endorsement of the General Conference of UNESCO in 1966, 1968, 1970 and 1983. In 1988, the Government of India passed the Auroville Foundation Act to safeguard the development of Auroville according to its Charter. Governmental and Non-Governmental Organisations in India and abroad have funded various development programmers, and donations have been received from foundations all over the world.

**The Mother, founded the township in 1968 and gave its Charter.** *“Auroville belongs to nobody in particular. Auroville belongs to humanity as a whole. But to live in Auroville, one must be the willing servitor of the Divine Consciousness. Auroville will be the place of an unending education, of constant progress, and a youth that never ages. Auroville wants to be the bridge between the past and the future. Taking advantage of all discoveries from without and from within, Auroville will boldly spring towards future realizations. Auroville will be a site of material and spiritual researches for a living embodiment of an actual Human Unity” [4]*

Auroville wants to be the first realization of human unity based on the teaching of SriAurobindo, where men of all countries and faiths would be at home. Auroville is the city of universal harmonious culture. It is a world university of harmony.

**Interpersonal Harmony in Sri Aurobindo’s Thought.** According to Sri Aurobindo, Unity, Harmony and Solidarity are the ideals of Collective living. It is relatively easy to achieve outer harmony but more difficult to achieve inner harmony among people. Without this inner harmony, outer harmony is uncertain and unsustainable. Living and working together, though helpful, neither bring everlasting inner and outer harmony among people, nor can overtake unnecessary conflicts among individuals. To achieve an integral harmony we have to understand the major causes of conflict among individuals and also the factors, which lead to inner and outer harmony.

Unity and harmony within the individual is the foundation of unity and harmony in collectively. When the individuals in a community are at peace and harmony with themselves, it

leads to a spontaneous harmony in the community. So to bring unity and harmony in the community, every individual in the community has to make a conscious effort to integrate his body, mind and heart and his thought, feeling, will and action around some life-enriching values which unite people.

It is also seen that there are conflicts among religions. Regarding this, Sri Aurobindo wrote: "*The conflict of religions arises because each one claims the exclusive truth and demands complete adherence to it by the method of dogma, belief, ritual ceremony and prescribed acts. The solution would be to recognise that the real truth of religion is in the spiritual experience of which it is an outer formation*" [5].

Srinivas beautifully summarized this idea of Sri Aurobindo. The inner psychological fraternity made up of mutual goodwill is the basis of peace and harmony in a community. But for this to happen, goodwill should be not only mutual but also integral which means it must be present in thought, feeling and will. In the will this positive state of consciousness manifests as a constant and persistent urge for the well being of others. In the feeling it expresses itself as kindness, compassion, generosity, trust, forgiveness. In thought it is understanding, tolerance, non-judgmental attitude and benevolence. All these qualities of the mind and heart have to be consciously cultivated and their opposites have to be firmly and persistently rejected. In yoga this inner discipline is called Chitta-shuddhi, which means purification of the mind.

However, this inner fraternity created by human love, goodwill and compassion is not the highest state of unity and harmony. This inner fraternity prepares our individual consciousness to rise beyond human fraternities to the true and everlasting unity of the spirit in which we can feel our oneness not only with all human beings but also with all creation, human and non-human. To realize this spiritual unity, we have to enter into inner depth of our being and come into some form of direct or reflected contact with our inner most spiritual self in the stillness of our mind or heart. But it is not so easy. It can be generated through a process of progressive inner evolution, which prepares the inner being of the individual and collectively for moving forward towards the spiritual unity. The next stage is shifting of our consciousness from the surface level to the deeper subliminal and spiritual level where we can feel a concrete experiential unity. This can be achieved only through the psychological and spiritual disciplines of yoga.

This inner unity of consciousness expressing itself at the outer life as perfect mutuality and unity is the spiritual ideal of collective living. Hence Sri Aurobindo says:

*"Unity is the basis of the Gnostic consciousness, mutuality the natural result of its direct awareness of oneness in diversity, harmony the inevitable power of its force, unity, mutuality and harmony must therefore be the inescapable law of a common and collective Gnostic life"* [6].

*The ABC of Harmony* ([www.peacefromharmony.org/?cat=en\\_c&key=478](http://www.peacefromharmony.org/?cat=en_c&key=478)) and based on it harmonious education continue, develop and raise the ideas of Sri Aurobindo to a new level of the 21<sup>st</sup> century as a stage of harmonious civilization and world interfaith harmony on the foundation of global harmonious consciousness developed of this ABC.

#### **References and Notes:**

- [1]. The Mother 1978, Vol. 12
- [2]. The Mother 1978, Vol. 12, p. 40
- [3]. <http://auroville.info>
- [4]. <http://auroville.info>
- [5]. Sing, K. (2007) *Interfaith Harmony in A Globalized Society*, [www.TimesofIndia.com](http://www.TimesofIndia.com)
- [6]. Sri Nivasan, *Interpersonal Harmony: A Psychological Perspective* (A Featured Article), SAFIM, Sri Aurobindo Society, Pondicherry

#### **Bibliography: Writings of Sri Aurobindo:**

Sri Aurobindo Birth Centenary Volumes Published by Sri Aurobindo Ashram, Pondicherry, 1972.  
No. Title Pages

13. Essays on the Gita 490-507
  14. The Foundations of Indian Culture 108-122
  15. Social and Political Thought 37-47,180-194,231-245
  18. The Life Divine - I 122-141 and 271-289
  19. The Life Divine - II 683-731 and 916-963
  20. The Synthesis of Yoga - I
  21. The Synthesis of Yoga -II 616-626 and 673-674
- Sri Nivasan, *Interpersonal Harmony: A Psychological Perspective* (A Featured Article), SAFIM, Sri Aurobindo Society, Pondicherry

**Dr. Pravat Kumar Dhal**, PhD, M.SC., M.ED., Hindu faith,  
GHA-India member,  
Principal, Grizzly College of Education.  
**Address:** Koderma, Jharkhand (state), India  
**Mob:**+919430774502  
**E-mail:** [pravatkumar.dhal@gmail.com](mailto:pravatkumar.dhal@gmail.com)  
22/01/13

Nina Meyerhof

### Interfaith Harmony among the COE World Children

For the past 15 years there has been a growing swell for interfaith harmony. I remember my first introduction to this was for the annual opening of each UN General Assembly with the Inter-faith celebration to pray and meditate with religious leaders, ambassadors and others speaking on giving inner support to the leaders of our world as they planned to meet in the General Assembly. Originally this was held within the UN and at a local Church prior to the convening of the GA. Nana Apeadu, who is a Guide for Children of the Earth, would be invited to pour Libation for Kofi Annan thus even including the Indigenous Africans in this process. on 9/11, a disastrous day for the US, there was a major special ceremony calling all religions together. The Interfaith Center of NY became the visible action model for this. Now at the UN, interfaith has been integrated into the fuller understanding of the need it fulfills and we have the Interfaith Week starting in February as a global event.

Children from around the world within the organization of Children of the Earth have come together since 1990. They come together from all lands and all religions. They come from most unusual circumstances such as war torn Sierra Leone to out casted Native Americans from upstate NY to Mongolian orphan youth from the former USSR. All coming to learn, to live and to love. They stand with each other, to look at who and what is a “universal human being”, how is LOVE more powerful than FEAR and finally how to make PEACE. Peace...both inner and outer...equates to harmony.

We brought these young people together to our home, Hearts Bend in the US, to Aburi, Ghana to Japan to the mountains of Mt Fuji with the religious group of Byakkoto Mohawk Country to sit in POWWOW to the Buddhist meditation training of Dhammakaya in Thailand, always criss-crossing all religions and learning from our hosts.

Thus, these young people embraced Buddhism, indigenous teachings, Hindu practices, Christian thought, Jewish prayers and on and on. They all became cognizant that they are one family of humankind. This pilgrimage began at the home site and continues forward even today. They are the family of youth of Children of the Earth stretching across 50 countries and touching presently over 15,000 young people. They are the spirit of Children of the Earth and future stewards of our world. Children of the Earth's next endeavor is to create a Spirit Youth website for youth spirit ambassadors to communicate with each other and know each other as universally

conscious beings. They are being trained and as future leaders will lead us to new models of structural global interdependence and interconnectedness.

For years we traveled the world bringing groups of youth together and showcasing their new ideas. While focused on creating a Spiritual Forum at the UN and also formulating a World Spirit Forum in Switzerland, I began to realize that interfaith means one religion at a time being celebrated and recognized. I realized that if I am to advocate for the universal human as well as one family of humankind that we need to go beyond this nomenclature. For Children of the Earth, on our trip to Nepal with 20 people, we identified a new movement, that of INTRAFaITH...thus going inside the human being to spirit and bringing this spirit weaving of humans into reality. The identity of religion was, in my mind, to become an externalized dress code such as ethnicity or culture or any other country habits only an outward definition of the person.

So if we are to experience ourselves in harmony we must start from where we are the same and not believe and learn that it is the development of tolerance that teaches us to be united but rather that we are united by birth. We must start to define ourselves as intra-faith humans acting as individuals and in collectives with outer designs. Intra-faith is oneness. If we are to learn anything it is to remember that “We Are One”.

Teaching children to this new worldview harmonious unity of diversity and diversity of unity is of paramount importance in the era of globalization. This requires new, global textbooks with appropriate attitudes. COE issued a similar book, *Pioneering Spiritual Activism: A Handbook for Youth Leadership* for creating the needed positive social change. This book is distributed with accompanying youth trainings around the world ([www.coeworld.org](http://www.coeworld.org)). Another similar textbook is *the ABC of Harmony* (2012) prepared by 76 authors of GHA from 26 countries ([www.peacefromharmony.org/?cat=en\\_c&key=478](http://www.peacefromharmony.org/?cat=en_c&key=478)). These, and similar books, form the peaceful and harmonious consciousness which is the deepest foundation, source and potential for interfaith harmony and world peace in the 21<sup>st</sup> century.

**Nina Meyerhof, Ed. D.;** Jewish by birth, spiritual seeker,  
GHA Vice-President,  
Founder and President, Children of the Earth (COE).

**Address:** Vermont, USA

**Phone:** +802-862-1936

**Web:** [www.coeworld.org](http://www.coeworld.org)

**Skype:** nina\_meyerhof

**E-mail:** [nina@coeworld.org](mailto:nina@coeworld.org)

23/01/13

Maitreyee B. Roy

## Om Santi, Om Shanti, Om Shantihi: Hindu Concepts of Eternal Peace and Harmony

Om Santi, Om Shanti, and Om Shantihi are the three basic concepts in Hindu Philosophy talking of eternal peace and harmony throughout the universe. Thus the words Om Shanti have been ethically explained as a power that teaches us to maintain peaceful co-existence within the society with diverse socio-cultural surroundings. Om indicates Universe, Shanti is peace and serenity. All Hindu rituals thus begin with the words OM Santi, Om Shanti, and Om Shantihi. The words are uttered thrice at a time with an intention to overcome all evils associated with human existence. The basic concept Om Shanti talks of welfare of all in the universe irrespective of their caste creed religion instead of the diversity in their existence. To the Hindu philosophy the Hymns or Mantras should be uttered clearly and loudly so that the chanting sound of the ‘Mantras’ can create a direct effect on the human being and can clear off all bad effects from his

mind This is called Atmanang Sudhi, i.e. clear mind. The believers of Hindu Philosophy thus believe in the theory of clean mindedness through peace, harmony and help to all. Those who believe in Hindu Philosophy or Hinduism believe in the chanting sound of the Hymn Om Shanti which brings a change all over the universe starting from moon to sun and the sky.

The chanting sounds associated with the Mantras are expected to help the universe to come closer to each other and to think of the welfare of all. Thus Hindu Philosophy does not believe the territorial deviation of the people. The philosophy of Hindustan (Land of Hindus or Hindustan) teaches us to sacrifice our happiness for the benefit of all in the universe. It teaches us the concept, 'I am for you all and I am for all'. Hindus believe that if one sacrifices his life for the welfare of the universe, his entity as a human being will be assimilated with the universe and he will achieve the utmost satisfaction of life. Hinduism trains us the philosophy of sacrifice, it teaches us to recognize the contribution of all in our life. Also, it teaches us to sacrifice our happiness for the happiness of all. Thus all cultural activities in the Hindu families revolves round the words 'OM Shanti'. The word Om Shanti is chanted thrice at a time with the idea of eradicating three odds witnessed by human beings in their every day's life. In Sanskrit, these are referred to as adhi-daivikam, adhi-bhautikam and adhyatmikam.

Adhi-daivikam literally means "mental disturbances that come from God"—i.e. things that are utterly beyond our control: such as hurricanes, earthquakes, volcanic eruptions, floods, tsunamis, and other natural calamities etc and over which we have no control. To overcome these types of disturbances we utter the first shanty. Thus through these words we pray to God with the words "O God, may we be protected from these obstacles which are beyond our control."

Adhi-bhautikam literally means "disturbances that come from the world." That is the every day's activities. The Second Om Shanti includes those disturbances stemming from the world around us. This may be called, sound pollution, disturbances occurring in the surroundings etc. As opposed to the first category, we have some control over this second category of disturbances. So this Shanti indicates our prayer to God to protect us from the people and surroundings.

The third type of disturbance is the most powerful and, at the same time, the only one over which we have total control. Adhyatmikam means "disturbances stemming from the self." For one who is still identified with the ego, the people, places and things of this world stimulate one of two reactions in the mind—attachment or aversion. Whether we physical see someone we consider our enemy as we walk down the street or remember him during meditation, the mental turbulence that results is the same. Lust, jealousy, anger, sorrow, hatred destroy our peace. During meditation, pleasant memories also distract us. Hearing the sound of a jet plane flying overhead may mentally carry us off to a fabulous holiday we once took. Only after 10 minutes of day dreaming do we realize we have lost focus on our object of meditation. Thus unless we learn to control, lust, anger in us we will not be looked up as a human being and thereby in such society Shanti (peace ) is impossible to achieve.

Thus Om means absolute infinity and Shanti means peace and tranquility.

Hinduism does not preach fanatic religious beliefs, it emphasizes the need for the development of morality, ethics and values in the life of the people. The Hindu Philosophy, instead of preaching individualism in human beings, encourages collectivism. As such religious rituals as we practice within the community are expected to be done by those chosen from Brahmin community arte. Called Purohito` means those who thins for the welfare of the society `the term `PURO` indicates the community while `Hito` indicates welfare i.e. `Purohito` is a person who can talk of the welfare of the community and work for it too. Persons involves in religious rituals like Home Garga are called the Purohito. Thus the term Puro+Hito indicated the person who is engaged in conducting religious rituals involving welfare of the locality. Since the person is expected to satisfy the nature and think of the welfare of the community as a whole he is called the Puro+Hito. The very concept behind the involvement of a third person in religious rituals is to discourage the development of selfish interest in them by involving themselves in their own welfare.

However the practice of engagement of the third person gave birth to the negative aspects of Brahmanism and in the long run led to the development of sectarianism that dominated the country with their explanation of the concept of religious practices leading to religious superstition and religious fear complex created in the community compelling the people to accept the domination of this Purohito or Brahmin in the later part of the civilization and to accept the domination of the so called middle class intelligentsia ultimately dominating the society through their selfish interest. Thus it was at the initiative of the Brahmin that the class and the caste system and religious division in the society crop up. The Hindu Philosophy thus turns to Hindu religion. This resulted in the development of divisional attitude among the community and this destroyed the philosophical attitude of the people

What binds India together: India is a vast country with diversified religious sects and multi lingual groups residing together for years together and instead of stray incidences they remained united. The vast country was, although expedited by invaders, ~~they~~ instead of destruction the resources of the country were preserved and they protected the territorial boundaries as a source of their understanding. Starting from the story of Aryan and Dravidians to the Moghol emperor and the British rule the concept of peaceful co-existence continued to be preserved. Considering this history as a significant example of peace and harmony we have to accept the fact that it is due to the inherent rule of peaceful co-existence which existed in Indian people so they could maintain the territorial entity of the vast country. It was only due to Hinduism that the integrity of the country could be maintained. I was nurtured even in the 21<sup>st</sup> century Indian community. The significant contribution of Hinduism was the mutual understanding and peaceful co-existence as the country's territorial boundaries continued to exist even in the 21<sup>st</sup> century and will continue to exist. This is the specialty of Hinduism which is never a religion but a philosophy used to enrich the human mind through out the days of history.

The long, peaceful and harmonizing history of Hinduism in the country opens up the wide possibility of teaching *the ABC of Harmony* ([www.peacefromharmony.org/?cat=en\\_c&key=478](http://www.peacefromharmony.org/?cat=en_c&key=478)) in all educational institutions of the country, to provide conscious interfaith harmony in India and to delete from it all religious conflicts.

**Dr. Maitreyee Bardhan Roy**, Hindu faith,  
GHA-India Vice-President; Coauthor, *The ABC of Harmony*:  
[www.peacefromharmony.org/?cat=en\\_c&key=478](http://www.peacefromharmony.org/?cat=en_c&key=478).

Principal Basanti Devi College, 147B Rash Behari Avenue, Kolkata-700029. President,  
Beautiful Mind: a parental organization of special children.

**Address:** Kolkata, India

**Web:** [www.peacefromharmony.org/?cat=en\\_c&key=317](http://www.peacefromharmony.org/?cat=en_c&key=317)

**E-mail:** [maitreyee25@rediffmail.com](mailto:maitreyee25@rediffmail.com)

22/01/13

## Ayo Ayoola-Amale

### Interfaith Harmony in Nigeria

I am a Nigerian. I am a Catholic born into the faith. My country is a multi-religious, multi-linguistic, and multicultural society. I believe that interfaith harmony should be a way of life and a peaceful co-existence among practitioners of various religious beliefs. As a Nigerian I believe that our diversity can be a great asset if properly managed. Unfortunately, we face many of the world's greatest problems. We encounter injustice, poverty, disease and the scourge of religious terrorism and tribal conflicts in the midst of profuse abundance.

Nigeria is the most black populated country in the world and the citizens of these African nation cry out loud for harmony, peace and justice. We know that there will be no economic prosperity and development without peace.

In Nigeria, religious conflicts have occurred between the different religious backgrounds. The majority of Nigerians are peace loving, however a few are religious fundamentalists using violence and terrorism. They commit violence, promote conflict, and often appeal to limited sectarian interests.

These problems are restricted so far to the Northern parts of the country. The terrible bomb explosions by suicide bombers have traumatized residents of many northern cities. Consequently, a hitherto quiet and peaceful country has been turned into an unsecured place by the drivers of the conflicts who have ruptured the peace. It is glaring that these terrorists are not believers of God or the principles of peace and harmony that is so core to every religion.

Our diversity, differences in religion, ethnicity, tradition, and culture obviously make the tapestry of humankind meaningful. This humankind tapestry with its rich and complex imagery is the creator's tapestry. This epitomizes our common humanity, and our common destiny irrespective of our differences.

In Nigeria the reality is that, the root of the problem is the abuse of religion by corrupt leaders. The world's religions teach us the ways of peace and harmonious living, from the Christian's Bible, the Islamic Qur'an, the Torah of Judaism etc. For centuries religion has paved the path to peace, harmony and love.

Nigerians are very hungry for harmony and peace more than anything else. It explains the clamour for interfaith harmony in Nigeria. The Nigerian Government established a Nigerian Interreligious Council known as Nigeria Inter-Religious Council (NIREC), and the promotion of an interfaith peace initiative that is all-embracing and holistic. The interreligious council is co-chaired by leaders of the two main religions, Christianity and Islam in the country. The council's purpose is to focus on addressing the ideological and doctrinal drivers of the inter-religious, inter-tribal conflicts plaguing the country.

In my opinion all groups promoting interfaith harmony of religions in Nigeria and the Nigerian Interreligious Council should be committed to building harmonious co-existence and peace by ensuring security and counter extremism. The different religions in Nigeria have immense responsibility of creating value and respect for human life above any religious affiliation or belief. This universal responsibility is the real key to human survival. It is indeed the best foundation for peace. The purpose of religion is to cultivate positive human qualities like love, harmony, tolerance and peace.

The culture and tradition in my country for centuries has been the sisters' and brothers' keeper principle of love your neighbor as yourself. This obviously is in line with the Golden rule of Love your neighbor the way you would want to be loved.

In my country, this has for a very long time been our role, that of providing love and service to benefit our fellow Nigerians. The people of Nigeria live in a country that is multicultural and multi-faith, a diversity that was our strength, beauty and national pride.

Unfortunately the age of materialism and greed has long taken over our minds, and consequently, we can see that there is something seriously wrong with our current value system. Materialism and greed has led to gross inequality; and eroded our personal well-being. We have immense responsibility as human beings to ensure that we build communities of harmony, tolerance and love. In this vein I strongly recommend that all interfaith harmony organizations in Nigeria and indeed in the World should consider: TEACHING PEACE.

Peace education is very important for the education and enlightenment of the people. Peace education right from the home, the places of worship to the school. We need to train, educate and teach the different tribes, religions, age groups and the youth the importance of mutual co-existence, religious harmony and interfaith dialogue. The high school curriculum should include peace education. Ideally, it should be from the basic to tertiary level so as to



engage youth, who form the majority of the population and utilize their energies to promote interfaith dialogue and understanding.

*The ABC of Harmony* book (2012), created by 76 authors from 26 countries in the Global Harmony Association ([www.peacefromharmony.org/?cat=en\\_c&key=478](http://www.peacefromharmony.org/?cat=en_c&key=478)) is strongly recommended as a textbook for peace harmonious education in secondary schools all over the world. The use of this book will empower youth leaders to shape society that is free from discrimination, bias and religious fundamentalism. It will deepen personal connections, promote harmonious living, build understanding, good will and a sense of community.

The role of youth in curbing terrorism is by promoting mutual understanding, religious tolerance, and inter religious dialogue. This will sensitize the local community for the promotion of a culture of peace, justice, interfaith, intercultural harmony, healing and reconciliation.

I believe educating people on the importance of tolerance and harmonious co-existence can play a big role in ameliorating interreligious conflicts in Nigeria especially in areas where education is lacking. These conflicts take place in Northern Nigeria where education is seriously lacking and in an area with a high population growth.

### A Poem: Humankind Tapestry

Woven wraps of clay colours,  
Woven in the beginning,  
Woven as pilgrim.

Pouring forth humanity like an unending spring.

Woven through oneness that root life full,  
Woven through oneness that sing wholeness,  
Woven as one.

Pouring forth sunshine into the depth of minds.

Woven as thunders of harmony broken into souls  
Woven souls turning swords into ploughshares  
Woven as human.

Pouring forth inner and outer disarmament to sanctify all souls laughing with the sun.

Today, falling every season like autumn long grown dead  
a beauty shattered like war, in worldly wraps found herself dust.  
All hurrying to shatters in a deep storm, Bereaved.

**Ayo Ayoola-Amale**, Catholic faith,  
Poet, Writer, Lawyer,  
Senior Lecturer & Head of Department of Law, Fac of Law, Kings University,  
GHA Vice-president, GHA-Africa President & Ambassador of Harmony for Africa,  
Founder/President Splendors of Dawn Poetry Foundation.  
**Address:** Accra, Ghana and Nigeria  
**Web:** [www.peacefromharmony.org/?cat=en\\_c&key=524](http://www.peacefromharmony.org/?cat=en_c&key=524),  
[www.splendorsofdawnpf.org](http://www.splendorsofdawnpf.org), [www.ayor.webs.com](http://www.ayor.webs.com)  
**E-mail:** [ayo@splendorsofdawnpf.org](mailto:ayo@splendorsofdawnpf.org)  
08/01/13



Bruce L. Cook

## Personal Examples of Interfaith Harmony

I was fortunate to be born into an interfaith situation. In my case, my father, grandfather and great grandfather were involved in publishing religious lesson plans and other documents for all varieties of the Christian faith, and this broad range continued until the 1960's. Since that time, while that publishing house has tended to narrow its focus, I learned of the "ecumenical" movement while in graduate school at Temple University and since then was privileged to travel to many areas of the world and meet people from a wide variety of faiths, not Christians alone.

During this time I learned that Christian, Jews, and Muslims were all "People of the Book," and I wondered how many people in these religious faiths were aware of their stunning commonality, for what I learned as the Old Testament is accepted by so many people of the world.

Today in the USA international cooperation is emerging from a dim awareness in the public mind of the past, and a still more dim view when it came to accepting beliefs other than Christian. However, strong movements are now forming in which each of the religious faiths leans forward to others in deliberate efforts to transcend differences. I would like to give two interfaith examples from my personal experience:

(1) **My Home Town.** In Elgin, Illinois, my own home town, where ecumenism was once championed in what was started in the 1950's (by my parents and others) as the Elgin Council of Churches and was renamed the Elgin Federation of Churches by the 1960s. A decade later, in the '70s, the name became to the Clergy Association of Greater Elgin. Then, in 1982, Elgin Cooperative Ministries was formed. These developments were notable in their focus on unity among Christian churches.

While these movements had great value in recognizing unity among Christian places of worship, in the late 1980's the group included the Baha'i faith. Today it has become an inclusive interfaith group called the Elgin Coalition of Elgin Religious Leaders. Its membership is made up of clergy (ordained), rabbis, imams and lay religious leaders: 77 congregations and sixteen friends. As recently as 2002, the group met monthly. Today, they meet bimonthly, once every two months, over lunch, typically on the third Tuesday of the month.

(Source [http://elginreligiousleaders.com/?page\\_id=20](http://elginreligiousleaders.com/?page_id=20))

(2) **My Brother's Home Town as an Example of Muslim/Christian Unity.** More recently, I was pleased to learn that my brother, Greg Cook, helped to found an interfaith group in his home town called the Muslim Christian Group, which is notable in its willingness to confront controversial differences that exist after 911 and other disturbing events. It is the Muslims and Christians United: A Lehigh Valley Initiative for Justice and Peace, organized by members of Wesley United Methodist Church and First Presbyterian Church of Bethlehem, Pennsylvania and the Muslim Association of Lehigh Valley, Whitehall (near Allentown), Pennsylvania. As an example of their progress, they have scheduled a 3<sup>rd</sup> January meeting to discuss Jihad. From their website, walv.org:

MALV represents a multi-ethnic and vibrant community of Muslims residing in Lehigh Valley. The center is built on 7 acres of land and includes a mosque, library, fulltime Islamic elementary school and weekend Islamic school. The present facility of 14,000 square feet is insufficient to accommodate the rapid growth of the community. An expansion plan to increase the size of the facility is in progress. Phase I of expansion was completed in 2008 with addition of 80 parking spaces. Planning for phase II of expansion is in progress which includes construction of new elementary school and gymnasium.

MALV offers the five daily prayers, and weekly halaka (religious education for brothers and sisters) year around. MALV also has monthly family dinners with invited guest speakers, an annual fun fair, and various youth programs. MALV maintains strong ties with other religious groups and participates in interfaith activities, community service programs and other social

events. It is democratically governed by eight elected members of the Board of Trustees and eight elected members of the Executive Committee.

Sources:

<http://muslimschristiansunited.blogspot.com>

[www.mcall.com/opinion/mc-bw-muslims-christians-20120217,0,2334144.column](http://www.mcall.com/opinion/mc-bw-muslims-christians-20120217,0,2334144.column)

<http://muslimschristiansunited.blogspot.com/>

[www.wmalv.org](http://www.wmalv.org)

[www.bctv.org/special\\_reports/government/centering-on-peace/vmix\\_c6856754-448e-11e2-80a1-001a4bcf887a.html](http://www.bctv.org/special_reports/government/centering-on-peace/vmix_c6856754-448e-11e2-80a1-001a4bcf887a.html)

[www.youtube.com/watch?v=oARJXqQYL00&feature=plcp](http://www.youtube.com/watch?v=oARJXqQYL00&feature=plcp)

**Bruce L. Cook**, Ph.D., Catholic faith,  
GHA-USA Acting President. GHA Ambassador of Peace and Disarmament from Harmony.  
Publisher and Editor. President, World Writers Resources, Inc. Author, *Harmony of Nations*:  
1943 – 2020, Just Fiction Editions, 2012.

**Address:** 7337 Grandview Ct. Carpentersville, IL 60110 USA

**Phone:** 312-859-8090

**Web:** [www.harmonyofnations.com](http://www.harmonyofnations.com), <http://author-me.com>,

[www.peacefromharmony.org/?cat=en\\_c&key=544](http://www.peacefromharmony.org/?cat=en_c&key=544)

**E-mail:** [cookcomm@gmail.com](mailto:cookcomm@gmail.com)

Glenn T. Martin

## On My Multi-faith Religious Experience

My parents brought us up as kids in a (northern) Baptist church. As a teen-ager I used to take notes on our pastor's sermons. In my College years (long ago), I attended the Universalist-Unitarian churches in Buffalo, NY and New York City. And I have occasionally given the sermon (talk) at the UU church near here, having long understood the unity of all the faiths and the deeper spirituality underlying them. Abroad, I have worshipped or meditated with others in Catholic, Protestant, Buddhist, Hindu, Baha'i, Oomoto, Shinto, and Moslem settings (most recently last week in the wonderful 'Blue Mosque' in Istanbul). Locally, a few years back, I meditated with the New River Zen Buddhist Community for four years, exploring the deeper spirituality behind all the faiths, and I have worked closely politically with the progressive local people from the Catholic, Methodist, and Presbyterian churches in this area.

I have long studied the writings of 'liberation theology' (especially Christian, Gandhian, and Buddhist) as well as many fundamental texts in the (universal) philosophy of religion. I have also published articles and written about the spiritual essence of all the religions, especially in my book, *Millennium Dawn*, which resulted from my study of mysticism in all faiths. However, it may be that my own views are closest to those expressed in my article "The Religious Nature of Wittgenstein's Later Philosophy" (*Philosophy Today*, 1989). Wittgenstein declared "I am not a religious man, but I cannot help seeing every question from a religious point of view."

Hence, I do not affiliate with any particular faith. In our family life, we practice rituals from several different faiths, especially, Christian, Jewish, and Buddhist. on our dining room wall, we have a large calligraphy in Arabic quoting the Qur'an.

**Dr. Glen T. Martin**, Multi-faith,  
President, World Constitution and Parliament Assoc. ([www.wcpa.biz](http://www.wcpa.biz))  
President, Institute on World Problems ([www.worldproblems.net](http://www.worldproblems.net))  
Professor of Philosophy and Chair of Peace Studies at Radford University  
([www.radford.edu/gmartin](http://www.radford.edu/gmartin))

Coauthor, *The ABC of Harmony*: [www.peacefromharmony.org/?cat=en\\_c&key=478](http://www.peacefromharmony.org/?cat=en_c&key=478)

Address: Radford, USA

Web: [www.peacefromharmony.org/?cat=en\\_c&key=428](http://www.peacefromharmony.org/?cat=en_c&key=428)

E-mail: [gmartin@RADFORD.EDU](mailto:gmartin@RADFORD.EDU)

Laj Utreja

## Lifetime Achievements of Interfaith Mission Service in Huntsville, AL, USA

### **A Brief Description**

Founded in 1970, the Interfaith Mission Service (IMS) is a unique and successful experiment in building a beloved community – a place of religious acceptance, racial harmony and justice. Drawing from the strength and resources of Huntsville’s diverse faith groups, IMS is a partnership among congregations. Its core objectives are responding to human needs and promoting acceptance through education and action. Member congregations take ownership of IMS programs, which provide a way for citizens to come together for service, fellowship and dialog. Working side-by-side to alleviate suffering also fosters understanding, appreciation and a spirit of oneness.

We believe that the many initiatives undertaken by IMS here in the Deep South – an area once soaked in resistance to racial integration and civil rights progress – have begun to change the landscape to one of racial, religious and cultural harmony.

During the turbulent 1960s and 1970s in Huntsville, white churches barred black families from attending. Even this community, steeped in the vision of new worlds as NASA’s home, found itself impeding new possibilities. In this soil of oppression – a most unlikely place for interfaith cooperation – eight Christian and Jewish congregations began to plant the seeds of racial and religious respect.

As a product of the civil rights era, IMS member congregations chose to take unpopular and at times risky stands to follow a dream of interfaith cooperation in the face of racial tyranny. These congregations formed a partnership to collaboratively close gaps in Huntsville’s social services and to build bridges to religious, racial and cultural harmony. What we present in this article is their story.

Today, we face new challenges, but our legacy forms the bedrock on which we stand in confidence and unity. In a world characterized by technological advances, increased migration, an interdependent ecology and a global economy, we believe that unity and interfaith cooperation have never been more crucial. As we face the challenges of the 21<sup>st</sup> century, IMS has a story to tell to a fragmented world that needs to hear it. We are grateful for your consideration of our proposal.

### **The Journey**

At IMS, we call it “The Journey.” It began in 1969 when racial tension was severe, unions were striking and urban renewal programs were just getting started in the Deep South. Nine congregations – Christian and Jewish -- joined hands to create an interfaith partnership that extended beyond the capability of any single congregation. Three decades later, IMS has more than 50 member congregations who continue to promote religious, racial and cultural harmony, and to respond to human needs. Our journey testifies that when people and their institutions believe that diversity of faiths, races and cultures is an asset, they can leverage that asset to enhance the community’s quality of life. In the next paragraphs, we delineate IMS’s lifetime accomplishments and our vision for the future – creating what Dr. Martin Luther King, Jr., called the beloved community – a place of tolerance and harmony.

## **The Journey to Promoting Religious, Racial and Cultural Harmony**

Huntsville – home of America’s first space exploration programs – is fortunate to have residents from more than 150 countries and at least a dozen distinct faith traditions. Many are high-tech workers employed by government, business and academia. This highly educated and diverse community has influenced the life of the area by insisting that inclusiveness and respect are essential in maintaining harmony in the community. They believe that understanding other faith traditions enhances each individual’s pursuit of truth within his or her own spiritual tradition. And, from a practical standpoint, this harmony-in-diversity can become the mechanism for improving the quality of life and for sustaining and attracting new business. The IMS programs that derive from these beliefs are highlighted below.

### **Interfaith Dialogue**

An Ecumenical Dialogue series began in 1987 as the community became increasingly diverse. Interfaith dialogue events include study forums, youth rallies and dinners conducted for the general public and for small groups within congregations. We reached a milestone in 2005 when the member congregations began inviting IMS to make interfaith presentations as part of their own educational programs. To date, approximately 100,000 people have participated in the bi-monthly programs, approximately 650 youth have been involved in the youth rallies and another 100,000 people have attended diversity dinners.

### **Interfaith Celebration and Season of Unity**

The first event was held September 15, 2001, in compassionate response to the terrorist attacks on the World Trade Center and the Pentagon. Its purpose was to provide an opportunity for the community to come together for prayer and worship, and to demonstrate unity. Since the first occasion, it has become an annual event that includes a day of justice celebrated through community service and interfaith unity.

During the “Unity Weekend,” hundreds of volunteers go to homes, businesses, shelters and convalescent homes to help others – with hammers, mops, brushes and shovels, or just by listening. Last year more than 250 volunteers visited 22 sites. We continue to learn from this hands-on community service that it is difficult to stereotype a human being who is now known to you in the breaking of bread, sweat or laughter. The weekend concludes with an Interfaith Celebration that brings citizens together for reflection, readings from sacred texts, a ritual for reconciliation, prayers, music, interfaith litanies, dance, candle lighting and a ceremonial departing with fire. Last year, around 300 people participated in the concluding ceremony.

### **“One Huntsville” Diversity Dinners**

Beginning in 1990, the diversity dinners have been held monthly at a local restaurant. The goal is clear: improve human relations by fostering friendships that cross the lines of race, faith and culture. “One Huntsville” promotes networking community problem solving, valuing diversity finding common ground, sharing projects and exchanging community information – all over a good meal and an educational program or forum. Currently, 20-30 people attend each monthly dinner.

### **Interfaith Summit**

In February 2007, IMS organized a highly successful 4-day interfaith summit, *“If It’s Broken, Fix It – A Search for the Sacred.”* Two distinguished speakers – Dr. John J. Thatamanil and Rabbi David Saperstein – spoke on the permeability of religious boundaries as fostered by King and Gandhi, and on the roots of Jewish social justice in action, respectively. Summit participants attended an Islamic prayer service, a Jewish Sabbath service and a Christian worship service. They enjoyed ancient Hindu dances and an interfaith dialogue on nine major world religions. Over 1,200 people attended the 4-day summit. We were gratified that the summit could be presented on a \$2,200 budget.

In June 2009, IMS organized another highly successful interfaith summit, “*An Emerging Ethical Renaissance*” Interfaith Panel – Representatives of their faiths addressed common questions, including the similarities and differences in their core values. They were asked pointed questions regarding situations in which their faiths were linked with situations and they provided some guidance to people of their faiths to correct the situation. In addition, Dr. Sheshagiri Rao (Chief Editor, Encyclopedia on Hinduism) presented ‘Human Values in a Global Society, Prof. Yitzak Landau (Dir. Interfaith Relations, Hartford Seminary) spoke on interfaith education and Jewish-Arab peacemaking, Dr. Elizabeth Kiss (President, St. Agnes College) stressed the importance of human values in education, and Imam Khalid Latif (Chaplain and Director of the Islamic Center at NYU) focused on Jewish-Muslim relations and conflict resolution.

Co-founders of Global Dharma Center, William, an internationally recognized expert on values-driven innovation, and Debra, focused on spirituality as the basis of leadership and work, Deborah Levine covered human values in business and Brenda Martin, Huntsville’s Multicultural Officer discussed the role of human values in the city. The summit concluded with representatives from Huntsville’s faith communities, who tackled ethical questions. Two of the highlights of the Summit were: *Human Values in the Home*, featuring representatives of the Marriage Coalition and the Baha’i Common Virtues Initiative and *Justice as a Human Value*, featuring representatives of the Alabama Poverty Program, Alabama Arise, and the Alabama Faith Council.

Over 1,000 people attended the 3-day summit. The summit received many accolades from the attendees.

### **Heart-to-Heart Hometown Pilgrimage**

The Heart-to Heart Hometown Pilgrimage is another successful experiment intended to foster greater understanding between local faith communities. Over a span of 10 weeks, 10 congregations opened their services to faith neighbors to deepen understanding of each other, without proselytizing or coercion but in a spirit of respect. This pilgrimage embodied the traditions of walking with one another and touching those things of the holy other with awe and reverence. Beginning in 2006, when there was standing room only during these stops along the common road, the program has continued prompting us to vary its execution every year. The Hometown Pilgrimage is accomplished with no budget.

### **The Journey to Social Justice**

In 2010, recognizing the need to inform the community on public policy issues and asking, “Do policies reflect the model of justice and mercy our congregations adhere to?” IMS added Social Justice Ministry in its services. The IMS programs under this Ministry area are highlighted below:

#### **Just Faith**

Beginning in 2010, IMS undertook a 30-week program, Just Faith, which instills in participants a passion for justice and prepares them for the work of social ministry. Meeting weekly, small groups of 10-15 use books, videos, lectures, and discussion to study the call to be agents of compassion and healing. Originated in the Roman Catholic faith, Just Faith also has an ecumenical version.

#### **Social Justice Topic Studies**

Social Justice Topic Studies program offers small groups a way to engage a particular topic in a deliberative style rather than debate or advocacy. Topics being studied include constitutional reform, predatory lending, tax reform, death penalty, restorative justice, health care, and care for the environment. Course study guides explain why the topic is in the public conversation and provide a faith perspective, enabling the groups to find common themes for action.

### **The Journey of Responding to Human Needs**

From its inception, IMS has worked with other community organizations -- civic, religious and cultural -- to develop solutions to meet human needs. IMS has undertaken this journey by creating a number of organizations, such as *Hospice* and the *Food Bank*. As a “parent,” IMS has successfully spun off many of these organizations into independence and maturity. Some examples are described below:

#### **A sampling of IMS human needs programs that are now independent**

Since 1978, *CASA* (Care Assurance System for the Aging and Homebound) has been providing volunteer services to assist the aging and homebound population. Organized in 1970, *HELPLine* (Huntsville Emergency Line Program) has provided telephone crisis intervention and information, answering nearly a million calls for help since the first call was taken in July of 1971. In 1999, *HELPLine* merged with *HOPE Place*, which has provided safe shelter to over 9,000 women, children, and men since 1982. *LIFT* (Living in Family Transition) was organized in 1985 to provide transitional housing for homeless families. These organizations created by IMS and then spun off as vital, energetic are brand names in the community. Several have million dollar budgets, with much of that funding from public and private sources outside of the community.

#### **Ongoing programs currently funded by IMS**

The *FoodLine* food pantry system was organized in 1970 to provide emergency food to families in need. Currently there are 20 congregations in the *FoodLine* network that operate food pantries, serving approximately 12,000 people annually. Many more congregations supply food to these pantries. The clearinghouse functions are performed by a group of volunteers at the IMS office.

*IMS First Stop* – our showcase project in the human needs area – opened for business in February 2002. *First Stop* helps the chronically homeless attain permanent housing. Our clients get meal packs, hygiene kits and a place during the day to shower, do laundry, be sheltered from the weather, and work with case managers to move into housing. Their various faith backgrounds are nurtured without judgment. Reaching this vulnerable population has helped Huntsville move toward becoming a beloved community.

Since *First Stop* opened, more than 800 people have used the drop-in center. Case managers currently work with 300 people, helping them get past such barriers to employment and housing as mental health problems, alcohol/drug problems, lack of education and skills, and physical or mental disability. Case managers have placed more than 45 individuals in permanent housing so far. Volunteers from the community provide a significant resource each month to keep the center running effectively. Until it makes its own way, *First Stop* receives approximately \$200,000 of our \$250,000 annual budget.

#### **The Journey to the Future**

Our vision for the future is to establish a teaching center for interfaith cooperation. Among the many educational programs of this center, we plan to study *the ABC of Harmony* ([www.peacefromharmony.org/?cat=en\\_c&key=478](http://www.peacefromharmony.org/?cat=en_c&key=478)) as the scientific basis of global and interfaith harmony, because harmonious education would provide harmonious consciousness needed for the most profound and lasting foundation of interfaith harmony leading to a harmonious civilization.

With the support from faith groups as agents of togetherness, we will continue to promote family as the building block of any community, develop personal relationships for living in harmony and provide and maintain affordable housing for the needy.

No single congregation could have sewn these seeds of faith, community service and cultural harmony. IMS has acted as an agent of reconciliation to help avoid actions that polarize



the community. Through IMS-initiated training, workshops and programs personal relationships have been built, bridging religious, racial and cultural differences. These relationships form a network of experience and trust that empowers change and contributes greatly to the quality of life we enjoy and the beloved community we have begun to create in the Tennessee Valley.

**Dr. Laj Utreja** has worked in various capacities, as hands-on engineer, as technical leader in people management, and as CEO of a small business. He has been an ardent student of Sanatana Dharma for most of his adult life. His reverence for Bhagavad Geeta has in part motivated him to write his two books, "Who are we?" and "What is our origin?" He is founder of the Institute of Spiritual Healing (ISH); GHA Vice-president; Peace Ambassador, IAEWP; Director, Institute of Global Harmony, Gandhi Vidya Mandir. My faith is Sanatana Dharma (the Eternal Truth); Coauthor, *The ABC of Harmony*: [www.peacefromharmony.org/?cat=en\\_c&key=478](http://www.peacefromharmony.org/?cat=en_c&key=478)

**Address:** 122 Foxhound Drive, Madison, AL 35758, USA

**Web:** [www.peacefromharmony.org/?cat=en\\_c&key=353](http://www.peacefromharmony.org/?cat=en_c&key=353)

**E-mail:** [lutreja7@gmail.com](mailto:lutreja7@gmail.com)

Varant Z. Seropian

## The Challenges to Interfaith Harmony in the Middle East and their Responses

The Middle East, a place of diversity and so called religious conflicts. It is the birth place of the world's major religions. People of the region are in a never ending conflict even within their own religion. Faith issues are never to be a matter of conflict and the use of military brutal force is no more to be accepted.

People must be educated to live in peace and harmony with each other and accept each other's differences. Faith is a personal issue, it is the inner you, what you believe in and how you see matters from your own perspective. While there is an absolute truth about the creation and the purpose of human life on this planet, there is also the human struggle for power, greed and control. Some communities chose to settle matters and control fellow citizens of other faiths through making them either accept their beliefs or just live as second level citizens or just the easy way go and immigrate to another country of their similar faith.

This concept of thinking and living was the case for more than hundreds of years but in a slow rhythm. Nowadays this rhythm started to take a super fast highway as we already see changes in MENA countries. The Middle East is getting emptied of all Christians in a rapid and gradual manner. This is not a myth but a truth and all statistics show that in years to come the number of Christians in MENA region will be negligible.

The call of UN and the resolution to recognize World Interfaith Harmony week in the coming month of February has to be looked at in a serious and humanistic manner. All calls from all over the world including MENA country political and religious leaders must be taken into consideration. Words are not enough anymore - actions must be more than words. People want to live in peace, harmony and prosperity. MENA country people of all religions and faiths are fed up with the brutal behavior of third parties which, instead of helping to resolve matters, have made this part of the world a place to settle their own issues at on the expense of the locals.

It is now the time that the UN recognizes and hears the calls of all the good people living in this part of the world and helps them solve their differences. NGOs that have the good intention of making this planet a blessing must also assist in educating citizens in matters of peace, harmony and teaching people how to live with each other by accepting the other no matter what their faith or belief is.

Religious leaders have a major task in this concept. They can either be a blessing or can be curse for their communities. They can either bring people together by teaching about God's

teachings and the truth about creation and purpose of human to live on this planet or they can be a curse by making people hate each other because of some religious differences.

The concept of religion and civil democracy is kind of mixed-up in this part of the world and it is the role of the UN through its different organizations, NGOs and representative offices to help leaders recognize these matters and give them the necessary tools to rule in peace.

God in all religions and faiths is the God of peace, harmony, forgiveness and love. How come you say you love God and your daily behavior shows the opposite, that you hate your neighbor, you do harm, you invade others' lands, you interfere in others' life to make it a misery and list goes on.

We have never seen "good" we have never seen resolution of conflicts, we have never seen peace, we have never seen human rights, we have never seen happy faces, and we have never lived tranquility and harmony. This is the words that you hear from the people of MENA countries. The big question is still WHEN?

It is very nice to hear philosophical discussions and read books and theories but the most important is the outcome .What has been done? What has the entire world done? It is to be known that MENA countries are not a junkyard; they are not a place for major countries to settle their differences in the expanse of the life of poor people.

It is time for action. February 2013 is near and people of this entire region are watching closely for the week of World Interfaith Harmony. Leaders of all countries and religions hear that you have a very major moral, ethical and conscious responsibility. You either simply fail or you put the first foot step towards reforms and understanding in a rapid way. People can tolerate no more; violence is no more expected in this era. Humankind is evolving and not devolving. People want to live with respect, prosperity and love. Faith issued MUST not be an issue of wars, struggles, hatred or negative way of behavior. on the contrary diversity in all aspects must be respected and studied to help our species evolve in a more prosper and positive way.

Through GHA and similar sister associations all educated people and educators must unite to assist this project by putting aside all differences and all matters of clash and struggle to make this planet a better, safer, balanced place to live in peace, harmony, prosperity and love.

Our decisive response to the challenges of interfaith harmony in our region is harmonious education for all its countries based on the scientific *ABC of Harmony* ([www.peacefromharmony.org/?cat=ru\\_c&key=504](http://www.peacefromharmony.org/?cat=ru_c&key=504)), which is acceptable to all our nations. We favor the establishment in the MENA countries of schools of similar kind, projects of which are created in the GHA ([www.peacefromharmony.org/?cat=en\\_c&key=461](http://www.peacefromharmony.org/?cat=en_c&key=461)) and it has long been proposed them to the region's governments and NGOs – it is, in our view, the only, if not quick, but a reliable way and the response to the challenges of interfaith harmony and lasting peace in our countries.

With all prayers for the success of the GHA World Interfaith Harmony project not only for the month of February but all year round. This must be a daily project and something not to forget till the ultimate goal of understanding and harmony is achieved.

With all prayers for the success of the GHA World Interfaith Harmony project not only for month February but all year round. This must be a daily project and something not to forget till the ultimate goal of understanding and harmony is achieved.

**H.E. Grand Dr. Prof. Sir Varant Zareh Seropian**, Lebanese-Armenian Christian faith;  
GHA Ambassador of Peace and Harmony from Harmony in MENA,  
IAEWP-UN ESCWA representative.

Employment : Doctor Physician - Inventor - Scientist – Academician – Philosopher – Educator.

**Address:** POBox 70063 Antelias - Lebanon

**Web:** [www.iaewp.page.tl](http://www.iaewp.page.tl)

**E-mail:** [iaewp-un@live.com](mailto:iaewp-un@live.com)

23/01/13



## Chintamani Yogi

### Interfaith Movement and Current Politics in Nepal

#### **Interfaith movement in Nepal**

The Acronym of Never End Peace And Love is Nepal, so the fertile ground of Nepal has accepted and embraced any religion and religious movement in the country which will grow and is still growing. Religious tolerance has been one of the remarkable characteristics of the country. St Xavier's and St Marie's opened during Panchayat rule, a mosque opening in front of the Royal Palace and the Government helping Muslims for Hajj are some of the examples of Nepal's openness towards every religion. Due to geopolitics, minor misunderstanding has often taken place which relatively counts less and comparatively increased the interfaith movement. Some examples are:

a. Nepal Interfaith Movement

With the help of Sakriya Sewa Samaj located at Thapathali 6 years ago this Movement has been helping to raise awareness about HIV AIDS to all the religious leaders.

b. National Interfaith Network Violence Against Women

STEP Nepal has taken a great initiative to stop any sort of violence against women in Nepal.

c. Interfaith Council Nepal

For the last 7 years this council has been pressurizing government and various political parties with the help of religious leaders for peaceful settlement in the country.

Similarly, Sai Sewa Samiti, Art Of Living, Satya Prem Pariwar, Prajapati Brahma Kumari, Ramkrishna Mission, Gandhian Organization, are working praiseworthy.

Although only a tiny country on the world map since 1950, after Rana was overthrown Nepal reached to the outer world, and the outer world increased its program and projects inside the country. Some of the religious, non-religious and interfaith programs now taking places in the country are as follows:

a. Religions for Peace Nepal (RfP-Nepal):

This New York, US based organization has a long history which may be the first international interfaith organization working in the country for peace.

b. Universal Peace Federation (UPF):

Rev Sanmyang Moon is the founder of this organization and has been conducting wonderful work in the country.

c. Global Network of Religions for Children (GNRC):

Based on a book "Learning To Live Together" (LTLT), this organization aims to promote ethics in education. It also marks Day of Prayer and Action for Children on November 20<sup>th</sup> each year. Hindu Vidyapeeth-Nepal, Shanti Sewa Ashram and Youth Society for Peace are some of the leading organizations working to promote ethics in education in Nepal.

d. United Religions Initiative (URI):

This organization is flourishing in more than 100 countries for the promotion of peace through various activities. In Nepal Youth Society for Peace (YSP) has been working as a cooperation circle for the promotion of peace.

#### **Some critical questions raised by current politics of Nepal:**

- a. Do we want a country or ethnic state?
- b. Do we promote the class struggle on the basis of ethnic group or by understanding?
- c. No matter where we reside or which religion we follow, some examples like Maghi help us to unite not to divide.
- d. We think about advanced scientific technology but talk about ethnic groups.

- e. Ethnic groups may migrate but hills, mountains and rivers are stable, so, the names of the places should be better kept based on nature and culture along with history rather than ethnic groups.
- f. Is development just identifying the problems or making a plan and formulating, monitoring and evaluating policies?
- g. Should illiterate and backward people be given equal opportunities or just rights?
- h. Should we embrace all as we are turning into a global village or should we battle for class division?
- i. Is it the time to talk about consistency and co-existence or dialectic materialism?
- j. Can we preserve nationality when we destroy national culture?
- k. Are we just talking about secularism or atheism?
- l. Can we preserve any other languages when we are terminating Sanskrit language?
- m. What could be the conspiracy for declaring Federalism and secularism in Nepal without a plan?
- n. What is Hindu extremism? Can we talk about extremism when we accept polytheism,, reincarnation and multi faith within Hinduism.
- o. Can secularism cover Dhammam Saranam Gachhami as well?
- p. Who wants secularism? Is it the public, political leaders or foreigners?
- q. Can secularism protect the indigenous culture?
- r. Are we trying to introduce secularism like that of India?
- s. What if national culture also becomes secular? What if people start to kill cows in the name of cultural secularism?
- t. Polytheism, Reincarnation, multi-scriptures, multi-rituals, multi-philosophy, multi-policy is what we Nepalese have been accepting. Is it not enough to prove independence and freedom of religion?

### **The current solution of the problems**

There could be many solutions but the important thing to bear in mind is positive thinking and appreciative inquiry for one's own religion and respect for other religions, multiplying the nationalism in deed.

- a. Let us respect all cultures without forgetting our own roots.
- b. Let us respect all the mother tongues without forgetting our national language.
- c. Let us be united and think about the national need rather than a personal or group's need.
- d. Let us respect all the ethnic groups without hindering nationalism.
- e. It is the vote that counts in democracy but voters need to be well trained and educated.
- f. Political leaders are raising issues to end class, but they are dividing us into various classes.
- g. Prevention is better than cure so let's be conscious about duty rather than rights.
- h. Is there a difference between an indigenous group and an ethnic group?
- i. Let us not forget that the concept of ethnicity was created by the slavery of the British Empire in India.
- j. Ethnic groups do not remain in the same place.
- k. Poor and backward groups / communities should get an opportunity, but how?
- l. Are we accepting all the grants by donors so that we can divide ourselves into Arya and Anarya?
- m. To raise the standard of the poor does not mean to kill all the rich people.
- n. Human history shows expansionists were the enemy, but now each ethnic group is becoming the enemy.
- o. We fought to stop foreign invasion but are now fighting to make new borders within the border.
- p. If we could have understood Buddha and Gorakhnath then we would not have to start a silent war of dialectic materialism.

- q. The poor are taught how to use gun and slogans but not the development of skill and positive attitude.
- r. Class struggle may divide the unbreakable relationship of Hindu and Buddhist in Nepal.
- s. Are missionaries working with a slogan of human rights fair and just? Are they multiplying Christianity in Nepal with vested interest?
- t. In fact we need Sangham Saranam Gacchami, not federalism and ethnic division.
- u. Indigenous worship of nature and theory of worshipping nature is in Veda.
- v. A nation may not have religion but of course it needs to have an identification and prestigious history.
- w. Hinduism embraces all the religions and respects all at the same time.
- x. Nepal is an open museum for the study of society and culture.

### **Conclusion**

We need a clear, deeper understanding among all the religions. To have peace and better understanding we need courage to have a boundless study of all the religions and embrace any religion and religious point of view respecting our own. Let us correct ourselves and the way we look at situations, because until and unless we are able to ignore the things we will find differences. Peace is an utmost factor for the all around development of a person, community, nation and a country. So, let us have a humble dialogue among different religions and reach a conclusion as Mahatma Gandhi said - 'There is no way to Peace; Peace is the way.'

But this way will be the most effective through the general harmonious education of believers from different religions, which is possible on the basis of a global scientific textbook *the ABC of Harmony*, which was created in 2012 by an interfaith group of scientists and artists of 76 co-authors from 26 countries of the world: [www.peacefromharmony.org/?cat=en\\_c&key=478](http://www.peacefromharmony.org/?cat=en_c&key=478). Only such education will provide to the believers common harmonious consciousness as the most firm spiritual base for interfaith harmony of different religions.

**Dr. Chintamani Yogi**, Hindu,

GHA World Ambassador of Peace and Disarmament from Harmony,

Founding Principal, Hindu VidyaPeeth-Nepal (HVP),

Founding Chairperson, Shanti Sewa Ashram (SSA),

Patron, Youth Society for Peace ( YSP),

Founder, Society for Value Education (SVE),

Chairperson, Nepal Inter-faith Movement (NIM)

Coordinator- GNRC-Nepal

**Address:** Po. Box: 6807, Kathmandu, Nepal; Ph. 00977-1-5527924 /5006125,

**Web:** [www.cmyogi.org](http://www.cmyogi.org), [www.hvp-nepal.org](http://www.hvp-nepal.org), [www.peaceservicenepal.org.np](http://www.peaceservicenepal.org.np),

[www.childrenspeacehome.org](http://www.childrenspeacehome.org)

**E-mail:** [mail2cmyogi@yahoo.com](mailto:mail2cmyogi@yahoo.com)

12/02/13

Sunita Singh Sengupta

Living the Interfaith Harmony: Experiences of Sri Ramakrishna

*"As many faiths, so many paths. The paths vary, but the goal remains the same. Harmony of religions is not uniformity; it is unity in diversity. It is not a fusion of religions, but a fellowship of religions based on their common goal -- communion with God. This harmony is to be realized by deepening our individual God-consciousness" –*

Sri Ramakrishna

Sri Ramakrishna Paramahansa, the greatest spiritual leader of 18<sup>th</sup> century (1836-1886) from India, talked and emphasized oneness of God and advocated harmony in religions ‘God is, one, the ways may be different’ was what he experienced through his different spiritual experiences in Kali’s Temple, Masjid, Gurudwara and church and hence started emphasizing harmony of religion. According to him it is not the fusion of religions but a fellowship of religions based on their common goal – communion with God. This harmony is to be realized by deepening our individual God - consciousness (Dasgupta, 2001).

*Religion always in India, says Sri Aurobindo, precedes natural awakening. Shankaracharya was the beginning of a wave that swept round the whole country culminating in Chaitanya in Bengal, the Sikh Gurus in the Punjab, Shivaji in Maharashtra and Ramanuja and Madhavacharya in the South. Through each of these a people sprang into self realization, into national energy and consciousness of their own unity. Sri Ramakrishna represents a synthesis, in one person, of all leaders. It follows that the movements of his age will unify and organize the more provincial and fragmentary movements of the past. Ramakrishna Paramahansa is the epitome of the whole. His was the great superconscious life which alone can witness to the infinitude of the current that bears us all ocean words. He is the proof of the power behind us and the future before us. So great a birth initiates great happenings* (Swami Sundarananda, 1986, p. 246).

Sri Ramakrishna is a perfect incarnation of Hindu genius and his greatest contribution to the world of thought is his declaration of the harmony of all religions after actual realization of their highest truths. In one life of 50 years and odd, Sri Ramakrishna lived ‘the five thousand years of national spiritual life, and so raised himself to be an object-lesson for future generations. Out of his direct perception of the truths of all the religions, he declared the existence of the one and only supreme Being, and not more than one, who is worshipped as Brahman by the Hindus, Buddha by the Buddhists, Christ by the Christians and Allah by the Muslims just as the same water is named differently in different languages’ (1986, p. 248).

Sri Aurobindo says:

*The world moves through a new synthesis of religious thought life – free from intolerance, yet full of faith and fervor, accepting all forms of religion, because it was an unshakable faith in One. The religion which embraces science and faith, Theism, Christianity, Mohammedanism, Buddhism and yet is none of these, is that to which the world spirit moves. It is such a synthesis embracing all life and action in its scope that the teachings of Sri Ramakrishna have been preparing* (1986, p. 248).

Mahatma Gandhi said (Courtsey- Advaita Ashrama, Calcutta):

*The story of Ramakrishna Paramahansa’s life is a story of religion in practice. His life enables us to see God face to face. No one can read the story of his life without being convinced that God alone is real and that all else is an illusion. Ramakrishna was a living embodiment of godliness. His sayings are not those of a mere learned man but they are pages from the Book of Life. They are the revelations of his own experiences. They therefore leave on the reader an impression which he cannot resist. In this age of skepticism Ramakrishna presents an example of a bright and living faith which gives solace to thousands of men and women who would otherwise have remained without spiritual light. Ramakrishna’s life was an object- lesson in Ahimsa (non-injury). His love knew no limits, geographical or otherwise. May His divine love be an inspiration to all... M.K.Gandhi*

The vast and all – comprehensive synthesis arrived at by Sri Ramakrishna is a spiritual verity. It was not designed, but discovered; it was not reasoned out, but revealed. It has, therefore, all the permanence of a natural law or scientific truth. Why then in our vision is the harmony of religion dimmed. I would like to quote a story from ‘Ramakrishna and His Unique Message’ written by Swami Ghananada and published by Advaita Ashrama, Kolkata in 2005 (p.142):

*The story is told of a forester and a lion who were walking together and fell to discussing the inevitable question. Who is stronger - a lion or a man? Finding it utterly impossible to solve*

*the problem to their mutual satisfaction, they continued walking and came suddenly upon a piece of statuary representing a man in the act of throwing a lion. 'There,' exclaimed the forester, 'you see, man is the stronger!' 'Ah! Yes,' replied the lion, 'but their positions would have been reversed if a lion had been the sculptor.' Man usually portrays religions other than his own in ugly colours. It is rather as every mother thinks her own child the most beautiful in the world.*

Tolerance, reconciliation, co-operation and fellowship of faiths are the graduated steps to be achieved for establishing the harmony of religion. Sri Ramakrishna lived this harmony of religion. Swami Vivekananda proclaimed at the Parliament of Religions at Chicago – ‘Do I wish that the Christian should become a Hindu? God forbid. Do I wish that the Hindu or Buddhist should become a Hindu or a Buddhist, nor a Hindu or a Buddhist to become a Christian; but each must assimilate the spirit of others and yet to preserve his individuality and grow according to his own law of growth’ (Swami Vivekananda, Chicago Address).

It is only through the friendly contact amongst religions that we can pave the way for fellowships amongst cultures and civilizations. Swami Ghanananda writes, “...The unity of purpose and the affinity of aspirations underlying the acceptance of the harmony of religions will diffuse from the plane of religion to the plane of cultural thought, and pave the way for the concord of cultures and symphony of civilizations. Communal and national as well as regional and racial cultures and civilizations will be benefited by contact between themselves. They will lose the spirit of narrowness and exclusiveness and contribute their share to world culture and world civilization” (2005, p.139).

To conclude.

Sri Ramakrishna’s idea of a Universal Religion was based on the synthesis of sectarian beliefs. He, after practicing Hinduism, Christianity, and Islam boldly, declared the oneness of different religions – based on his profound realization of the ultimate reality. He recognized the differences among religions but held the view that in spite of these differences every religion has an essential core of spirituality which constitutes the common ground of all religions.

Now, almost 130 years after Ramakrishna, after the creation and presentation in New Delhi on February 11, 2012 the global textbook *ABC of Harmony* ([www.peacefromharmony.org/?cat=en\\_c&key=478](http://www.peacefromharmony.org/?cat=en_c&key=478)), humanity and all believers became possible to achieve social and interfaith harmony, which declared Ramakrishna at the highest spiritual intuition. *The ABC of Harmony* opened the way for this and any like social harmony at the level of social science, which deepens, extends and develops intuition. It allows us to learn a common scientific theory of social harmony in a global harmonious education, which forms a global harmonious consciousness as a very profound and strong foundation of social, religious and interfaith harmony. The GHA Interfaith Harmonious Education Project is the first world attempt to implement this opportunity.

#### **References:**

1. Dasgupta, R.K.(2001). Sri Ramakrishna’s Religion. Calcutta: The Ramakrishna Mission Institute of Culture.
2. Swami Ghanananda (2005). Sri Ramakrishna and His Unique Message. Kolkata: Advaita Ashrama.
3. Swami Sundarananda (1986). Ramakrishna: The Symbol of National Unity. Paper Contributed In the book “Sri Ramakrishna: The Great Prophet of Harmony”. Kolkata: Advaita Ashrama.

**Sunita Singh Sengupta, Ph.D.,** Hindu,

GHA Ambassador of Peace and Disarmament from Harmony for India,  
Professor of Organizational Behaviour, University of Delhi ([www.fms.edu](http://www.fms.edu))

Founder & Honorary Convener

Integrating Spirituality and Organizational Leadership Foundation.

Address: Delhi, India

Web: [www.isolindia.org](http://www.isolindia.org) E-mail: [sunita.singhsengupta@gmail.com](mailto:sunita.singhsengupta@gmail.com)

12/02/13

Daurenbek Aubakir

## Archaic Syncretism Harmony in the Ancient Religion of Tengri

The ancient religion Tengri, the cultural core of many of the ancient peoples of Asia and uniting their different religious beliefs, has been little studied. When were these archaic beliefs formed in a single religion? The exact answer to this question is not easy. We only know the name of their God - the Almighty Tengri religion. What was the religion of harmony syncretism? Does it impact on the religions of other people and if he underwent exposure to other religions? These problems were in the orbit of our attempts at comprehension.

### **Historic Retreat and Review of Scientific Papers**

Of scientists who have dedicated their works to the Ancient Tengri religion not much is known. The first were the Frenchman Jean Roux and Russian scientists I.V. Stebleva, S.G. Klyashtorny. The relationship between religion and the ancient Turks Manichean religion was thoroughly investigated by M. Mayllard. Continuity of worship and shamanism bakhsi of Central Asian people, saving up to XX-XXI centuries of the cult of the ancient Turks, became an object of research of L.P. Potopov, A.V. Anokhin, S.D. Maynagashev, Ch. Valikhanov N.P. Dyrenkova and copyright information, G.D. Sanzhaev, N.A. Alekseev, O. Purev, S.M. Abromzon, P. Pellew, G.P. Snesarev and others [1-4].

Some signs of religious beliefs of the ancient Turks remained in the memory of today's descendants of ethnic groups: Mongol and Manchu-Tungus. That opens the door for further study and discussion of the problem of Ancient religious bent.

The outlook and spiritual values of the ancient Turks, Mongols and Tungus-Manchu were often limited in the scientific tradition to primitive beliefs. In modern science, it is understood as a blind faith in natural phenomena, followed by worship of their objects. We turn first to the three scientists who gave the first, and the most accurate in our view, the scientific interpretation of the Ancient religion.

French explorer Jean Roux says, "the cult of the ancient Turks Hagan could not rise to a truly popular religion, it remained at the level of simple faith". Stebleva, also staying in the same opinion, brings her back to polytheism. At the highest level - Tengri, on average - Umai, on the ground - Jer-Suv (land, water), and below - Aruahi ancestors. Klyashtorny, considering the ancient Turkic religion as "shamanism" and "bakhsi", the world divides into three levels: the upper, middle and lower. God is the top of the world - Tengri. It acts on all living things, animate and inanimate. Umai his motherly way - female womb, the defender and protector of children. Jer-Suv - the god of the middle world, Erklig - the god of the lower world. German scientist G. Doerfer (Dörfer) makes the first scientific conclusion, arguing that the religion of the ancient Turks was "Tengrianism" which meets the requirements to be called a religion, and not just the ancient belief. [5] But it retains the archaic harmony and syncretism of ancient beliefs and is the first in religion in the deification of the consent of nature, society and man and the gods in the personification of this agreement and their mutual coordination.

### **A Look at the Nature of the Ancient Religion**

Supporting opinion of the West Turkic scientist G. Doerfers takes an attempt in the direction of archaic syncretism of harmony. For this we must first answer the question: what is the response of religion and what religion is a measure of transcendence?

Consider these features and the following figures:

1. God is neither in heaven nor on earth!
2. God is not born, he was not born!
3. There are "This world - White Light" and "Another World"!



4. Heaven, Hell - as is!
5. "End of the World" - should be!
6. Religion has a strong place in the mind, the soul of the ethnos, people, it becomes a way of being, and ethical behavior in everyday life.
7. Origin, evolution and transformation of ethnicity being directly under the religious understanding of the world, religious and philosophical worldview.
8. The presence of a separate place of worship a deity.

These eight criteria are crucial, in our opinion, in order to distinguish between religion, including the world, and religious beliefs.

Religions of the world this day - Buddhism, Judaism, Christianity and Islam - meet all of these eight criteria in full.

Shall we subject the religion of the ancient Turks to the test of these criteria?

On the concept of ancient Turkic Tengri (**teŋri**) - either on earth or in heaven, and - for him, for his dome: **Üzekökteŋri** (Tengri the heavens) (text on the stele Kyultegin, L.N.Gumilyov ENU, Astana).

Tengri - the only creator. Himself no one is created, not born.

"White light" - living space. After death, the soul of man flies to "Another World". It does not die, and does not disappear: **Külteginqojjylda [toquzynčyaj] jitijigirmikeučdy** (Kyultegin year ram seventeenth ninth month flew) (text on the stele Kyultegin).

It says here that the soul Kyultegin had flown while the body was left in the world. Flown away the soul disappears. In the other world - a different world awaits her good or plight. Hence, they were able to distinguish between the Hell from Paradise, and the problem of different worlds - the "white light", "Otherworld" - "another world" they knew.

If one angers Tengri or spirit of the Earth, then comes the "End of the World." All people will experience their punishment and a general feud will begin: **Teŋrijerbulyaqynüçün**.

Ancient inscriptions drafted that any animate or inanimate life exists on the instructions of one creator - Tengri. It was called "Two bases, three times": **Ekijlytyzüčöd**. That was the basis of the philosophy of understanding the world of ancient Turks.

Of course, the Turks have left behind the Scriptures which became the basis for modern rational world religions. All their ideas are expressed in the form of the first intuitions and allegory with many meanings and archaic syncretism harmony inherent in all religions, from which stories crystallize divine actors (leaders) and the creators of universal harmony in various Holy Books.

### **Tengri Religion as the First Monotheistic Religion - Much in Common with Harmony**

Nomads wandered ten millennia on the super continent Eurasia, which extends to the east foothills Hyangan in the west to the Caucasus Mountains. They worshiped one God, being faithful to the canons of monotheistic religion Tengri, while their sedentary neighbors - the Chinese, Indians, Persians, and Slavs - were of polytheistic religions. Monotheism came much later. This allows us to formulate a hypothesis about the influence of religion, with its archaic Tengri syncretism harmony to the emergence and development of the monotheistic religions:

- Buddhism VI-V centuries BC
- Judaism VIII-VII centuries BC
- Confucianism VI-V centuries BC
- Daoism VI-V centuries BC
- Christianity III-I centuries BC
- Islam In III-VI centuries AD.

The idea of the presence of initial connection leads to the question of how these religions pray.

In Buddhism two hands folded and bring your hands to the forehead

In Islam two open palms first stretch forward and then put it to the face and figure



In Judaism two hands.

All of this is as if praying Tengirshilik (Tengrianism): Two hands with open palms up in supplication stretched forward to Tengri.

Tengri religion influenced the birth of the monotheistic religions by the archaic power of his syncretism of harmony, which proved to be more viable and meets the basic needs of all nations, uniting them in a harmonious social and cultural diversity.

### **Excursion in the Name of the Religion Tengri Expressing Syncretism Harmony**

Neither the ancient Turks, the Mongols have retained the written word "Tengrianism", "religion Tengri", "tengrianic religion". Even these names are not in the speech of these ethnic groups. Therefore, the question of the name of this religion is still left open. With "light hand" European scientists offered a nickname "Tengrianism", but this name was contrived, not true. Intensive search in the runic text on stone stele, given their results, has found the real name of this religion.

In Orhon inscriptions were found the following texts [6]:

- Byogyu Hagan (**bögüqayan**) (text on the stone stele TuiUkuk);
- Byogyu Khan (**bögü qan**) (Türkische Turfan - Texte II);
- Byoge-budrach, Byoge-Iavgach (Kutadgu bilik of Mahmud Kashgari).

There was a custom of the ancient Turks, who took over Mongolians in ancient times before heading to a campaign, on the eve of the battle, set in-chief Godminister, and gave him time to foresee the outcome of the battle. Only after the prediction of a positive outcome was a farewell given, and the army withdrew. First Western translators perceived "Godminister" as Hagan's eldest son Kapagan Hagan. A more detailed study enabled the accurate reading in the true interpretation of the word, but in was his sense means "chief Godminister", "chief priest," "head of Tengrian religion". It asks to remark: "Is it because the people - the descendants of the Turkic ethnic group"- forgot "or rather forgot the Tengri their ancient religion, as it has provided a" side "conqueror of all the peoples of the world and the conqueror Genghis Khan and his warlike descendants, as it happened with American Indians buried in oblivion of their religion (and, in some tribes that moved from Asia to 30 thousand years ago, this was the religion of God Tengri),after their conquest by the Spaniards" [7].

Let's see how these names are etched in the memory of the Kazakh people.

In legend, "Salih, Samain" is a sentence "**God TeṅriKekshe saint - Auliye**". In the Mongolian secret Shezhire this proposal is: "**TyevTeṅriKekechuBögü**".

This shows that in the later transcriptions under the influence of Islam, the word "Bögü" replaces the word "Auliye" - a saint, "bek", "begi", "begim" - powerful, capable, powerful, respectively. Therefore, in the Kazakh speaking and in written texts instead of "Bogu" we read "Auliye" ("ata"), "begi", "begim": KonyrAuliye, KylyshbekAuliye, Becket ata, Baydibekata, Uzunata; kus-begi (kusbegi - who is able to tame the bird, meaning wild birds of prey), at-begi (atbegi - able unbridle horse, meaning wild or feral horse), Aiganymbegim (Aiganym powerful mother ChokanValikhanov) etc.

Concluding the above, we can assert that the ancient religion of the ethnos "Bögü" and not "Tengrianism" that emerged 30-40 thousand years ago, was in effect a monotheistic religion that came to our days with the changes and transformations. It spawned a harmonious pluralistic world view, perception of religion and philosophical outlook Byogyu waiting for researchers to recover the full panoramic picture of this truly grand heritage of all mankind, which was based on a deep archaic syncretism harmony, and therefore of particular interest to the threshold of its global harmonious civilization. This civilization is born in the 21<sup>st</sup> century, creating for itself the key spiritual background and is primarily in the form of *the ABC of Harmony* [11] ([www.peacefromharmony.org/?cat=en\\_c&key=478](http://www.peacefromharmony.org/?cat=en_c&key=478)), on a scientific basis upon which was created this project of sustainable inter-faith harmony in the new civilization. It is its spiritual key factor, the origins of which are lost in the archaic syncretism harmony Tengri.

Given the past greatness and inestimable value of this ancient religion in the development of humanity, it is fair to define the place of honor at the Palace of Peace and Accord in Astana for religion Byogyu. Everyone knows that there were four leaders of the Congress of World Religions. Thus, all of us living today, would have the honor to themselves in a celebration of his own great story. on the other hand, this was a commendable name for homo sapiens lesson for living and future generations. We could cite dozens of sources [2] without diminishing their value, yet say that they discuss this problem in using the name "Tengrianism" and an outdated interpretation of its role in the life of the ancient Turks, as we have emphasized above. It will be hard to change this view, but still need to go to the true name of God Tengri religion - "Byogyu» - «böğü».

#### REFERENCES

1. Valikhanov Ch. Works, Almaty, 1984.
2. Sartkozhauly K. Aubakir D.A., Aubakirova D.D. Philosophical analysis of the impact on the modern world religions Tengrian Ancient Religions // Roc-Miras (magazine), 2005, № 4 (7), p. 41-48.
3. Abromzon S.M. Kirghiz and ethno genetic historical and cultural ties, L., 1971.
4. Pelliot P. Neuf notes sur des questions d'Asie Centrale // TP. Vol. 26, 1926, p. 212-216.
5. Doerfer G. Türkische und mongolische Elemente in Neupersischen. Bd. I-III, Wiesbaden: 1965.
6. Sartkozhauly K. Orkhon monuments, Astana Kyultegin, 2003, 392 p.
7. Dyrenkova N.P. Umai in the cult of the Turkish tribes // Culture and Literature of the East, III, Baku, 1928, p. 120-148.
8. Suleimenov O.O. Scripting Language. Looking into the prehistory of the origin of writing and language Small humanity, Almaty-Roma, 1998, 501 p.
9. Aubakir D.A. Harmony in science, technology and life - an inexhaustible source of life and perpetual motion machine intelligence, Almaty KazgosINTI, 2001, 200 p.
10. Gumilyov L.N. Ethnogenesis and the Biosphere / Comp. and general ed. A.I. Kurkchi, MA: Institute for CI-Dick, 1997, 640 p.
11. Semashko L.M. and 75 coauthors. *The ABC of Harmony for World Peace, Harmonious Civilization and Tetranet Thinking*, St. Petersburg, 2012.

**Daurenbek Aubakir.** Muslim. Ph.-Math.C., Ph.D., member of the Academy of IIA and ISAESNM, Professor Department of System Analysis and Control of Physics and Technology Department of L.N. Gumilyov ENU, Astana (Kazakhstan). Author of the book: "*Harmony in science, technology and life - an inexhaustible source of life and the perpetual motion of the intellect*" (Almaty, 2001, 200 p.).

**Address:** Astana, Kazakhstan

**Mobile:** +7-701-367-79-33

**E-mail:** [segiz-seri@yandex.ru](mailto:segiz-seri@yandex.ru)

19/02/13

Tatomir Ion-Marius

### Planting the Holy Thorn and Peace Pole in Glastonbury Town

26 January 2013, in Glastonbury, England, was an extraordinary event. The tree known as the Holy Thorn was planted in the heart of the town, along with a Peace Pole which has written on it in 8 languages (English, Dutch, German, Romanian, Spanish, Japanese, Hindi and Braille) the peace message "May Peace Prevail on Earth". The Holy Thorn planted is a very special tree, a descendent of the Holy Thorn that stood on Wearyall Hill. Legend says that the Thorn have sprung from the staff of Joseph of Arimathea, more than 2000 years ago when he came to Britain.

In September 2012 I visited the Glastonbury Pilgrim Reception Centre which has as manager Morgana West and inspired in her the idea of planting a Peace Pole. A Peace Pole is a monument that displays the message "May Peace Prevail on Earth" in various languages and can be made of different materials in varying sizes. The Peace Pole reminds us to act daily peacefully and in a harmonious way. There have been planted Peace Poles all around the world. The Peace Pole Project is the official Project of The World Peace Prayer Society, started in Japan in 1955 by Masahisa Goi. Morgana West embraced the idea and supported it with extraordinary efforts, presenting to the local council the proposal of planting the Pole. The local council with Mayor Ian Tucker approved the project appreciating its importance.

On 26<sup>th</sup> January, the event started in the town hall with beautiful harp music from John Dalton in a speech has been kept by the mayor of the town, Ian Tucker. After this, a ceremony of lighting special candles took place. I had the honour to lighten the Candle of Peace and said that I am lighting the Candle with the wish that may Oneness and Peace prevail. The director of the World Prayer Peace Society (UK), Caroline Uchima had travelled from Scotland to attend the event and spoke about the Peace Pole Project. Peace Ambassador Morgana West talked about the Glastonbury Thorn planting and its powerful message.

After the speeches, the event continued with the planting of the Holy Thorn and of the Peace Pole. Several dignitaries participated at the planting of the Holy Thorn and of the Peace Pole: Sue Thurgood, John Brunson, Denise Michell, William Knight, Jon Cousins counsellors of the town of Glastonbury, Ian Tucker mayor of the town, Morgana West manager of PRC, Lynne Sedgmore British Commander, Caroline Uchima director of WPPS for UK who came specially from Scotland, volunteers, the community of the town, visitors, etc. The Peace Pole has been placed close to one of the town's attractions, the abbey in whose courtyard is said that the legendary king Arthur has been buried.

The planting of the Holy Thorn was a very touching event, I felt very specially at the planting of the Tree at the Minute of Silence. After planting, the celebrations continued in the town hall with excellent music from the Avalonian Free State Choir and Tim Hall & the Archetypes. It must be known that Glastonbury is visited yearly by hundreds of thousands of tourists. The event has been intensely promoted in the media in the UK but internationally also. Glastonbury, holy place, blessed be!

Planting the Holy Thorn and the Peace Pole with the Peace Message in 8 languages, the Minute of Silence and lighting the Candles for Peace and Unity – all of these are the great emotional marks of interfaith harmony and world peace. These marks could use effectively in the global interfaith harmonious education on *the ABC of Harmony* base and similar global textbooks for world peace.

**Tatomir Ion-Marius**, Ecumenical Christian,  
GHA Ambassador of Peace and Disarmament from Harmony in Europe,  
Poet and Peace Worker,  
*The ABC of Harmony* coauthor: [www.peacefromharmony.org/?cat=en\\_c&key=478](http://www.peacefromharmony.org/?cat=en_c&key=478)  
**Address:** Maramures, Romania,  
**Web:** [www.peacefromharmony.org/?cat=en\\_c&key=274](http://www.peacefromharmony.org/?cat=en_c&key=274)  
**E-mail:** [tatomir@gmail.com](mailto:tatomir@gmail.com)  
22/02/13

#### 4. Internal Harmony Potential of Different Religions

These summaries of interfaith harmony and analysis articles earnestly evidence the powerful internal and millennia harmony potential of all religions, beginning with their appearance. This potential is expressed in the Golden Rule of religions, universal principles of religious harmony, in a common set of universal values and virtues, etc. We can safely say that in every religion God is the personification of the power of cosmic and social harmony as a whole, the embodiment of all its best natural and human qualities, values and virtues: love, peace, equilibrium, justice, consent, measure, brotherhood, coherence, happiness etc. Harmony defines them, they grow on its soil, but they also have a positive impact on it and strengthen it. Harmony is a good in general, it's positive and viable in the world, it is the fullest expression of God. Therefore, we can make a universal conclusion that the essence of religion is harmony, its benefit at the fullest of its positive qualities, values and virtues. It is their spiritual strength inspiring millions of believers to the heroic enthusiasm of countless human discoveries, grandiose achievements and heroic deeds in the name of God, as the embodiment of universal harmony and goodness throughout human history. God was and is the most powerful inner spiritual support of individuals and nations in all of human history, as in all its happiness as and all its sufferings. Religion has been and will remain the spiritual support necessary for humanity, all nations and people, without which their natural, harmonious existence is impossible.

However, religion is a contradictory phenomenon. It contains the antipodes of these qualities, values and virtues as their absolutization, extreme and excess, i.e. violation and denial of harmony. Absolutization of the religious extremes in fundamentalism, extremism, fanaticism and religious intolerance distorts and rejects harmonious essence of any religion. This is especially a problem in modern history, in the countless facts of religious wars, violence and hatred. But these facts also accompany human history. This means that the capacity of the internal harmony of religions is not enough to ensure their full and sustained interfaith harmony, which has not been achieved so far in history.

The internal harmony potential of religions is the first necessary condition for interfaith harmony, which is impossible without this fundamental premise. But, obviously, it is not enough to fully achieve interfaith harmony, which has not occurred for many thousands of years of religion.

Tholana A. Chakravarthy

#### The Winds of Interfaith Harmony

Autumn leaves flutter with the early morning gales  
Dew drops glitter under the warm reflective sunrays,  
The golden horizon unfolds another dawn, delightful;  
The longing for harmony unfolds in my thoughts castle,  
To enhance mutual understanding-cooperation among people.

Blessed are the flowers which during the night blossom  
Blessed are the cozy blossoms which for a tomorrow dream,  
Blessed are the clouds that decorate the sky with delight  
Blessed are we to cherish the harmony-promoting insight,  
And these dimensions of culture of peace, we should promote.

If the concept of 'love of God and love of one's neighbor'  
If endorsed, according to own religious traditions or fervor;  
The earth would become a safe place to live with joy, forever.  
Yes, why can't humans exhibit a bit of patience and tolerance?  
To ward off the ever-surging frictions and budding differences.

The tentacles of evil; 'hatred and ego-centric ambitions',  
The hassles of progress; 'injustice and non-cooperation';  
If both get conquered with trust, love and harmonization,  
Planet earth is bound to transform into an abode of heaven  
To experience equivalence and prosperity, instead of ruin.

The impact of religious harmony will shower ceaseless trust,  
And, the winds of change shall blow every atom of mistrust.  
Across the world's churches, mosques, synagogues and temples,  
If we spread the message of harmony, interfaith and goodwill,  
We are bound to unfurl a new era, magnificent and delightful.

**Dr. T. Ashok Chakravarthy**, Litt.D, Hindu faith,  
GHA Vice-president,  
Co-Director, Embassy of Human Rights from Harmony and Justice, Ambassador,  
International Poet-Review Writer; Universal Peace Ambassador,  
Coauthor, *The ABC of Harmony*: [www.peacefromharmony.org/?cat=en\\_c&key=478](http://www.peacefromharmony.org/?cat=en_c&key=478).  
**Address:** Hyderabad, INDIA  
**Web:** [www.worldpeacepoetry.com](http://www.worldpeacepoetry.com), [www.peacefromharmony.org/?cat=en\\_c&key=286](http://www.peacefromharmony.org/?cat=en_c&key=286)  
**E-mail:** [tacvarthy@gmail.com](mailto:tacvarthy@gmail.com)  
24/01/13

Bruce L. Cook

## Religious Congress in Chicago in 1893 as the Beginning of Conscious Interfaith Harmony

The interfaith movement has its origins in the late 19<sup>th</sup> century. Amazingly, the official beginning would be in Chicago, a city seldom thought of in terms of religion. Two important events occurred in Chicago: the Columbian Exposition of 1893 and the World's Fair in 1933.

The Boston Collaborative Encyclopedia of Western Theology gives a highly descriptive account of the Columbian Exposition based upon these two historical documents.

(See <http://people.bu.edu/wwildman/bce/worldparliamentofreligions1893.htm>)

Barrows, John H., ed. 1893. *The World's Parliament of Religions: An Illustrated and Popular Story of the World's First Parliament of Religions, Held in Chicago in Connection with the Columbian Exposition of 1893*. Vol. I. Chicago: The Parliament Publishing Company, 1893.

Barrows, John H., ed. 1893. *The World's Parliament of Religions: An Illustrated and Popular Story of the World's First Parliament of Religions, Held in Chicago in Connection with the Columbian Exposition of 1893*. Vol. II. Chicago: The Parliament Publishing Company.

Here is the encyclopedia's account:

"The 1893 World's Parliament of Religions, held on the shore of Lake Michigan, Chicago, was the largest and most spectacular event among many other congresses in the World's Columbian Exposition. The Exposition itself was a large trade fair that was to celebrate the quadricentennial of the discovery of America by Christopher Columbus. The organizing process of the Parliament began after Charles Carroll Bonney, a layman in the Swedenborgian church and the president of the World's Congress Auxiliary, appointed John Henry Barrows to administer the General Committee on the Congress of Religion, which eventually was called the World's Parliament of Religions. Under Barrows' leadership, the Parliament was expected to be "the most important, commanding, and influential, as surely it will be the most phenomenal fact of the Columbian Exposition" (in Ziolkowski 1993, 5). The committee consisted of sixteen persons from different religious backgrounds. Although most of them were from Christian

mainline denominations, we could find distinguished names such as E.G. Hirsch (Jewish rabbi from New York), Jenkin Llyod-Jones (Unitarian), and P.A. Feehan (Catholic bishop).

“In June 1891, more than three thousand copies of the Preliminary Address was sent out to the world, informing the plan of the 1893 Parliament and inviting religious leaders from all over the world to attend to it. The responses were varied and well documented in Barrows' two-volume report books (1893a, 18-61). The enthusiastic responses came from those like Max Müller, a champion in the field of comparative studies of religion. Although he deeply regretted failing to attend the Parliament, he expressed his hope that the Parliament would increase interest in the studies of religions. He also said that the Parliament “stands unique, stands unprecedented in the whole history of the world” (in Seager 1993, 154). Some other positive responses demonstrated particular interests, for instance, to show the supremacy of one religion over others or to clarify misconceptions about their religious traditions (Braybrooke 1980, 2).

“There were also those who disapproved. For instance, the Presbyterian Church in the United States of America, the home church of John H. Barrows, passed a resolution against this convention. Yet, the fact that this resolution was passed hurriedly in the closing hours of the General Assembly in 1892 did not produce unified voice among the Presbyterians; indeed, their opinion was divided. Further opposition came from the Archbishop of Canterbury, saying in his letter that his disapproval rested on “the fact that the Christian religion is the one religion. I do not understand how that religion can be regarded as a member of a Parliament of Religions without assuming the equality of the other intended members and the parity of their position and claims” (in Barrows 1893, 20-2). Along with these two, the sultan of Turkey, the European Roman Catholic hierarchy, and many North American Evangelical leaders such as D.L. Moody also opposed this convention.

“In spite of these varied responses, the 1893 Parliament had to be recognized as a great achievement within the modern civilization in general and the Western American culture in particular. As Marcus Braybrooke said, “it remains a remarkable pioneer event, and no subsequent inter-faith gathering has come near to it in size or complexity” (1980, 8). The glory of the Parliament was most obvious in the opening ceremony, on September 11, 1893. More than four thousand people had gathered in the Hall of Columbus, when at ten o'clock a dozen of representatives from different faiths marched into the hall hand in hand. At the same time, the Columbian Liberty bell in the Court of Honor tolled ten times, honoring the ten great world religions — Confucianism, Taoism, Shintoism, Hinduism, Buddhism, Jainism, Zoroastrianism, Judaism, Christianity, and Islam. The inaugural ceremony began with “an act of common worship to Almighty God,” in which Isaac Watts' paraphrase of the hundredth Psalm was sung (Barrows 1893a, 66):

“Praise God, from whom all blessing flow;  
“Praise him, all creatures here below;  
“Praise him above, ye heavenly host;  
“Praise Father, Son and Holy Ghost. (67)

“Afterwards, Cardinal Gibbons led the crowd in the Lord's Prayer, which interestingly became the “universal prayer” — to use Barrows' words — that marked the beginning of each day during the seventeen days of the Parliament.

“Statistically speaking, the Parliament was dominated by English-speaking Christian representatives, who delivered 152 of 194 papers. The opportunity for the leaders from other religious traditions was limited but significant; 12 speakers represented Buddhism, 11 Judaism, 8 Hinduism, 2 Islam, 2 Parsis religion, 2 Shintoism, 2 Confucianism, 1 Taoism, and 1 Jainism (Seager 1986, 87). Among them, Swami Vivekananda's three speeches undoubtedly drew most attention from the American public. Barrows recorded that when Vivekananda addressed the audience as “sisters and brothers of America,” they went into rapture with “a peal of applause that lasted for several minutes” (Barrows 1893a, 101).



“The whole program of the Parliament was designed to provide a wide range of topics presented by a great variety of speakers. Beside a large amount of papers focused on religion per se, several papers were categorized under the rubric of “scientific section” and “denominational congress.”

“More than seven thousand people attended the closing session on the seventeenth day. Several Christian hymns were sung before Bonney and Barrows delivered their concluding addresses. Along with them, some representatives also spoke to express their thanks and impressions. The “Hallelujah Chorus” from Handel's Messiah was then sung. About this Barrows commented,

“To the Christians who were present, and all seemed imbued with a Christian spirit, [the chorus] appeared as if the Kingdom of God was descending visibly before their eyes and many thought of the Redeemer's promise — “And I, if I be lifted up from the earth, will draw all men unto me.” (Barrows 1893a, 172-3)

“The Parliament was officially closed with the Lord's Prayer led by Emil G. Hirsch, a rabbi from Chicago.”

Also notable in the 1893 celebrations was the inclusion of meetings for female visitors as arranged by the World's Congress of Representative Women. Here the detailed account is found in:

The Latter -day Saints and the 1893 Chicago's World's Fair (Oxford, NY: Oxford University Press, 2011).

The second event was the World's Fair in Chicago in 1933. A succinct description for this event is offered by the Baha'i Reference library and the common law copyright book, *God Passes By*.

Shoghi Effendi, *God Passes By* (Wilmette: Bahá'í Publishing Trust, 1971), a Project Gutenberg eBook ([www.gutenberg.org/files/19275/19275-h/19275-h.html](http://www.gutenberg.org/files/19275/19275-h/19275-h.html))

Here is the description Effendi offers in the description of Baha'i (p. 351):

“Century of Progress Exhibition, held in Chicago in 1933, where no less than ten thousand people, passing through the Hall of Religions, must have viewed it every day--its replica forming a part of the permanent exhibit of the Museum of Science and Industry in Chicago; its doors now thronged by visitors from far and near, whose number, during the period from June, 1932 to October, 1941 has exceeded 130,000 people, representing almost every country in the world, this great "Silent Teacher" of the Faith of Bahá'u'lláh, it may be confidently asserted, has contributed to the diffusion of the knowledge of His Faith and teachings in a measure which no other single agency, operating within the framework of its Administrative Order, has ever remotely approached.”

These were momentous beginnings, and it seems surprising that the movement didn't become stronger in those early years. Even with the Christian faith, the World Council of Churches didn't begin until 1948\*, and further developments there concentrated on unity among the many strands of Christian belief and practice, each of which is often viewed as competing with others to become the one true Christian church.

In presenting our Global Harmony interfaith project, we hope to minimize that kind of competition and, instead, seek harmonious relationships and mutual respect among all religions of the world. In order to achieve global harmony, we need to focus on commonly accepted beliefs and put less emphasis on our differences. In this way, we can all learn from each other.

\*Howard C. Kee, et. al., *Christianity: a Social and Cultural History*, 2<sup>nd</sup> ed. (Upper Saddle River, NJ.: Prentice Hall, 1998)

**Bruce L. Cook**, Ph.D., Catholic faith,  
GHA-USA Acting President. GHA Ambassador of Peace and Disarmament from Harmony.  
Publisher and Editor. President, World Writers Resources, Inc. Author, *Harmony of Nations: 1943 – 2020*, Just Fiction Editions, 2012.



**Address:** 7337 Grandview Ct. Carpentersville, IL 60110 USA

**Phone:** 312-859-8090

**Web:** [www.harmonyofnations.com](http://www.harmonyofnations.com), <http://author-me.com>,

[www.peacefromharmony.org/?cat=en\\_c&key=544](http://www.peacefromharmony.org/?cat=en_c&key=544)

**E-mail:** [cookcomm@gmail.com](mailto:cookcomm@gmail.com)

Rene Wadlow

## The Faiths of the Past and the Challenges of the Future: The Start of Interfaith Efforts

There has always been interaction and borrowing of ideas among spiritual and religious groups. Early Christianity took ideas and rituals from the Jewish milieu of its early members including its founder, Jesus. However, ideas from the mystical traditions of the Middle East and Greece were also incorporated — Neo-Platonism as well as aspects of the Eleusinian and other initiation rituals. Christian Gnostic groups had relations with Zoroastrian thought and probably Buddhists from India.

In Europe during the 16<sup>th</sup> and 17<sup>th</sup> centuries, in reaction to the violent religious conflicts between Catholics and Protestants during the Reformation, humanists such as Erasmus appealed for tolerance and tried to find an intellectual basis for reconciliation. The Erasmian spirit found one of its most beautiful expressions in a small but influential group known as the *Domus Charitatis* (the Family of Love). Founded in the 1540s, the Family of Love recruited its members from all over Europe and included both Catholics and Protestants. The Familists placed an emphasis on the practice and growth of spiritual love as a way of building bridges between dogmatic religious positions.

During the same period of the 16<sup>th</sup> and 17<sup>th</sup> centuries, in a more esoteric way, the alchemists turned to a wide variety of sources in their search for a symbolic language to express the mystery of both physical and spiritual transformation. In addition to Christian symbolism, they used the symbolism of Greek and Roman mythology, Gnosticism, the Jewish Kabbal and Islamic culture. Drawing on such a wide variety of traditions, the alchemists paved the way for the gradual interest in the study of the world religions in Europe during the 18<sup>th</sup> and 19<sup>th</sup> centuries.

However, we can date the start of formal inter-religious understanding and cooperation from the first World Parliament of Religions held in Chicago. In 1893, interfaith dialogue was almost unknown in the United States when immigration up until that time was nearly exclusively Christian with the addition of a small number of Jews coming from Germany and Central Europe.

The 1893 World Parliament of Religions (sometimes called the World's Congress of Religions) was convened in Chicago in connection with the World's Fair of that year (1). The Parliament owed much to the efforts of its organizing president, John Henry Barrow. Barrow was a well-known Chicago lawyer as well as a Swedenborg minister. The Parliament was heavily weighed in favour of liberal Protestant denominations: the Unitarians, the Universalists, the Congregationalists along with two more conservative Protestant churches: the Presbyterians and the Baptists. The Roman Catholics were represented by the prominent Cardinal Gibbons.

Barrow depended on his contacts in Chicago with members of the Theosophical Society for advice on Asian religions. Thus Annie Besant, President of the Theosophical Society, living at its headquarters in India and active in Indian reform movements suggested the Asian speakers — all of whom represented a modern, social reformist wing of their faiths. Annie Besant participated and had insisted that there be an important contribution from women highlighting their specific roles — a theme then new to the largely hierarchical and patriarchal structures of religious groups.

Buddhism was represented by the theosophically-trained H. Dharmapala, an educator and social reformer in what is now Sri Lanka but not a member of the orthodox Buddhist Sanga of the island. The Zoroastrians were represented by an Indian Parsee, Jananji Modi, a friend of the Theosophical Society and a friend of the Oxford scholar of religions Max Muller who also played an important intellectual role in the preparation of the Parliament. Muller did not attend but sent a paper on “Greek Philosophy and the Christian Religion” which was read by Barrow. An aspect of Indian thought was represented by B.R. Nargarkara of the reformist Bhahmo-Sumaj who quoted its spirit saying “When scriptures differ, and faith disagree, a man should see truth reflected in his own spirit... We do not believe in the revelation of books and men, of histories and historical records for today God communicates His will to mankind as truly and as really as He did in the days of Christ or Moses, Mohammed or Buddha.”

The most striking voice of Indian thought came from the young Vivekananda (born Narendranath Datta to an aristocratic Calcutta family.) He alighted in Chicago in ochre robes and turban and gave a series of talks to the 4,000 attendees of the Parliament. Vivekananda, a follower of the more mystic thinker, Ramakrishna, defined Hinduism as a few basic propositions of Vedantic thought, the foremost being that “all souls are potentially divine”, and he quoted Ramakrishna that “the mystical experience at the heart of every religious discipline was essentially the same.” Being 31, Vivekananda had the energy to travel throughout the United States, meeting intellectuals who were discovering Indian thought not through translations of Indian scriptures as had Emerson and other New England writers but through a learned and dynamic Indian.

From the USA, his writings spread, influencing such thinkers as Leo Tolstoy and Romain Rolland who wrote a *Life of Ramakrishna* and a *Life of Vivekananda* (1928). Later the English writer, Aldous Huxley, wrote *The Gospel of Sri Ramakrishna*. Vivekananda’s enthusiasm for the USA as a new land unburdened by the old ways was boundless, and quite fittingly, he died on 4 July, 1902 — the US national day. He was just 39 years old but was exhausted from ceaseless work and untreated diabetes.

For many decades, the exposition of Indian thought by Vivekananda was considered to be Hinduism. It was not until the late 1950s and the coming to the University of Chicago of Mircea Eliade, the Romanian specialist of Indian religious thought that the many different strands of Hinduism were stressed. Hinduism was a term coined by the English colonists as they wanted a term to cover all Indian thought as they were already used to “Islam” for the Arabs and “Christians” for the West. At the start of the English colonial period in India, Indians never referred to themselves as Hindus, but used more often the term *dharma* —the law of Nature — for their faith. Likewise Buddhists also never spoke of themselves as Buddhists. Buddha was also said to have explained the *dharma* which had existed eternally, and they were only following the *dharma* as explained by the Buddha; they were not following the historical Buddha.

Since 1893, interfaith discussions have increased, but many of the issues have remained the same: how to make religious thought relevant to the social-economic-political issues of the day. Can religious organizations play a useful role in the resolution of violent conflicts? (2)

It is important to build on past efforts, but many challenges remain. These challenges call for responses from a wide range of people and groups, motivated by good will to break down barriers and to reconcile women and men within the world community.

The past efforts are not enough for interfaith harmony as it has not been reached between religions since 1893. Interfaith harmony is needed for a new spiritual and educational platform in the age of globalization. Such platform maybe *the ABC of Harmony* ([www.peacefromharmony.org/?cat=en\\_c&key=478](http://www.peacefromharmony.org/?cat=en_c&key=478)), created collectively at Global Harmony Association (GHA), which proposed the global harmonious education of all believers in this ABC and similar texts for the 21<sup>st</sup> century. It is the best and the most important challenge for the future faiths and their harmony.

## Notes

- 1) For a record of the talks and statement of the Parliament see: Rev Minot J. Savage *The World's Congress of Religions* (Boston: Arena Publishing Co. 1893, 428 pp.)
- 2) For a useful overview of recent multi-faith dialogue and cooperation by a participant in many of the efforts see: Marcus Braybrooks *Faith and Interfaith in a Global Age* (Grand Rapids, MI: Co-Nexus Press, 1998, 144 pp)

**Rene Wadlow, Prof.;** Liberal protestant,  
President, Association of World Citizens,  
Representative to the UN, Geneva. GHA member,  
Coauthor, *The ABC of Harmony*: [www.peacefromharmony.org/?cat=en\\_c&key=478](http://www.peacefromharmony.org/?cat=en_c&key=478).  
**Address:** Le Passe, France  
**Web:** [www.peacefromharmony.org/?cat=en\\_c&key=272](http://www.peacefromharmony.org/?cat=en_c&key=272)  
**E-mail:** [Wadlowz@aol.com](mailto:Wadlowz@aol.com)  
14/01/13

Rudolf J. Siebert

## The Golden Rule of Religions and Interfaith Harmony

The critical theory view

(Published: *The ABC of Harmony*, 2012, p. 134-136)

The Golden Rule appears in the different world religions in slightly different forms:

The Golden Rule says in its Hindu Form:

*This is the sum of duty: do nothing to others, which would cause you pain, if done to you* (Mahabharata XIII 114. 8).

The Golden Rule teaches in its Buddhist form:

*A state that is not pleasant or delightful to me must be so for him also; and a state which is not pleasant or delightful for me, how could I inflict that on another?* (Samyutta Nikaia V).

The Golden Rule states in its Chinese form:

*Do not do to others what you do not want them to do to you* (Confucius, Analects 15, 23).

The Golden Rule of Jainism says:

*A person should treat all creatures as he himself would be treated* (Sutrakritanga 1. 11, 33 anga).

The Golden Rule says in its Jewish form:

*Do not do to others what you would not want them to do to you* (Rabbi Hillel, Shabbat 31a).

The Golden Rule teaches in its Christian form:

*In everything do to others as you would have them do to you* (Matthew 7:12; Luke 6:31).

The Golden Rule states in its Islamic form:

*No one of you is a believer until he desires for his brother that which he desires for himself* (40 Hadith Sayings of Muhammad of an-Nawawi 13).

The Golden Rule says in its Wicca form:

*If you harm none, do what you will: what you give forth, will come back three fold.*

Informed by Jean Piaget, Lawrence Kohlberg and Karl-Otto Apel, Juergen Habermas has objected, that the *Golden Rule* in all its forms was not the Kantian categorical imperative, and rightly so. The Golden Rule is, of course, pre-modern, religious and material in all its forms, whereas the Kantian categorical imperative is modern, secular and formal. However, in the perspective of the dialectical religiology, the religious Golden Rule can also be inverted, translated, sublated, rationalized, formalized, and secularized in modern, post-modern, and post-metaphysical philosophical and social-scientific discourses into the principle of – what Kant had called – the categorical imperative:

*Act in such a way, that the maxim of your will can at any time also be valid as principle of a universal legislation. Or:*

*Act in such a way, that you use the humanity in your own person as well as in the person of every other human being always also as purpose, never merely as means.*

In their communicative or discourse ethics, Charles Pierce, Apel, and Habermas have translated, sublated, rationalized, formalized, and secularized further the religious Golden Rule and the secular Kantian categorical imperative into the principle of the apriori of the unlimited communication community:

*Your action is ethically valid, when it honors the five validity claims – truthfulness, honesty, rightfulness, tastefulness and understandability – and when it finds the consensus of the universal communication community, particularly of the possible victims.*

Habermas has admitted that modern secular ethics has a problem with motivation. Even after Apel's and Habermas' communicative or discourse ethics has verified the validity of an ethical norm, e.g. that it is better to love than to hate, or that one should not kill if one finds that convenient for oneself or for one's country, there still remains the question why a person should follow it? The secular categorical imperative or the likewise secular communicative ethics has no adequate answer to this question of motivation. The theologian Kueng had to admit, that certainly the world religions, as they motivate people, have always been and still are in temptation to command and give orders to human beings in a most authoritarian manner, and to demand from them blind obedience and to do violence to their consciences.

According to the critical theorists of society, Kant's categorical imperative commanded, that man should treat man never only as means, but always at the same time as purpose.

According to the critical theorist, what Kant's transcendental philosophy formulated as law of social morality, e.g. the categorical imperative in its different forms, was nothing else than the inversion, translation, and secularization of religion, particularly Judaism, Christianity, and Islam, i.e. the three Abrahamic religions. The critical theorists were convinced; that, contrary to Kant practical or theoretical reason, they could, with the exception of Buddhist or Christian reason, command just as much the very opposite of the Golden Rule or the categorical imperative, e.g. in the form of the instrumental rationality rooted in the human potential and evolutionary universal of work and tool.

According to the critical theorists, Kant's assertion of the identity of Christianity and practical reason was wrong. The moral believe; that love was better than hate, and that kindness was better than cruelty, and, to be sure, not in the positivistic or naturalistic sense of the more skillful tactics and strategies, but better in itself, was justified through nothing else than the cultural tradition in the West. The merely tactical or strategical rationality of business leads to Post-Modern alternative Future I – the totally functionalized, reified, bureaucratized, one-dimensional, technocratic society, in which every particular purpose turns right away into a means again, and in which there is no purpose or meaning as such, and to Post-Modern alternative Future II – the extremely aggressive, necrophilous war society, characterized by an ideology of death, and not to Post-Modern alternative Future III – the reconciled democratic society, which is open toward the entirely Other.

According to the critical theorists, in so far as the criminal law of the nation state was not opposed to it, infamies could be as rational as honesty. With the last trace of theology, as it seems to appear in Tillich's work, the thought that the neighbor was to be recognized and respected and even to be loved, not to speak of the love of the stranger or even of the enemy, lost its logical foundation. What, according to the dialectical religiology, not a few people besides the critical theorists experienced as the regression of the Western civilization, was deeply connected with the disappearance of the seriousness of life, which derived itself from religion, which Tillich and other theologians, e.g. Kueng and Metz, and Peukert and Arens, have tried to stop through their theological-philosophical writings, and not at last and not at least also the critical theorists through their dialectical theory of society up to the present – 2011 (Matthew 5: 20–48).

The critical theorist did not dare to predict the future effects of all these attempts to rescue religion and its ethics and morality in the post-secular society. The dialectical religiologist remembers all the great world religions, which went under for good: e.g. the Persian Religion of Light and Darkness, Good and Evil, the Syrian Religion of Pain and Suffering, the Egyptian Religion of Riddle, the Greek Religion of Beauty and Fate, the Roman Religion of Utility, many native African religions, the native American religions, etc.

The golden rule of religions and the categorical imperative, expressing the eternal ethical standards of social and interfaith harmony, which will be embodied entirely in the Future III as a harmonious civilization, a more detailed discussion in my fundamental book: *Manifesto of the Critical Theory of Society and Religion* (3 vols.), 2011.

**Rudolf J. Siebert**, (b. 1927), Roman Catholic faith, Professor of Religion and Society in the Department of Comparative Religion at Western Michigan University, Kalamazoo, Michigan, USA. He develops the Critical Theory of Society and Religion presented in about 300 scientific publications in 12 languages, including 28 books and 35 chapters. He is the leading researcher of the world religions Golden Rule as the first conscious principle of social harmony. Director of the two international courses: 1. "Future of Religion" in Dubrovnik, Croatia since 1975, and 2. "Religion in Civil Society" in Yalta, Crimea, Ukraine since 1999. He is the "Peace from Harmony" and GHA founder in 2005 and has the GHA highest Honorary Title: World Harmony Creator.

Coauthor, *The ABC of Harmony*: [www.peacefromharmony.org/?cat=en\\_c&key=478](http://www.peacefromharmony.org/?cat=en_c&key=478).

**Web**: [www.rudolfsiebert.org](http://www.rudolfsiebert.org), [www.peacefromharmony.org/?cat=en\\_c&key=51](http://www.peacefromharmony.org/?cat=en_c&key=51)

**E-mail**: [RSieb3@aol.com](mailto:RSieb3@aol.com)

Bishnu Pathak

## Principles of Religious and Interfaith Harmony

Harmony and peace go hand in hand as a cause and its consequence. Peace can come after chaos and bloodshed but it will be unstable and pregnant with a new war. In this case there is no possibility for harmony. Peace as the process through and from social harmony is a perfect and lasting relationship. Peace may be experienced alone by a human through harmony in a systematic character between two or more persons or parties. Harmony is always a plural condition. Peace may be enjoyed alone; harmony is living together peacefully. Peace implies calmness; harmony requires unity. Different religions in different ways express the dependence and the following of peace through and from harmony.

**Confucianism**: Harmony is the humanistic philosophy of good virtue that is adhered to with an essential code of conduct to be followed by a person, a group of people, and the society in all worldly matters. Human beings are imperfect and ever prone to make mistakes, but they also are teachable, improvable, and perfectible through self-cultivation and self-creation. There is a possibility for human error for which a person may be punished for not pursuing the rules. Our society is a community of human beings; the parents have the authority over their children and the employers have the authority over their employees.

**Daoism/Taoism**: Harmony has a naturalistic nature which entails the ultimate source of values for human beings. Harmony achieves the values with the Universe for which a human being must act or live in accordance with the laws and ways of the nature.

**Judaism**: Harmony is against the tit for tat "a leg for a leg and a tooth for a tooth". Harmony is an umbrella term in holy teachings and writings. Harmony believes on humankind, loving-kindness, holiness, daily conduct of gracious and merciful immanent. Harmony is a central sacred text that supports theism. Harmony is viewed as a set of general guiding principles and restrictions that are mostly practiced voluntarily.



**Buddhism:** Harmony is an accomplishment to imbibe peace in our minds. It is a cultivation of positive emotions, i.e. love and compassion, abandoning anger and negative state of mind, loving one another, and practicing altruism. If harmony begins from home, there will be social order in the nation; if there is social order in the nation, there will be peace in the world. Harmony teachings offer endless reincarnation and spiritual attainment through correct views and actions and transform the soul so as to get rid of all sorts of cravings, sufferings and sorrows. It is a path toward cessation of pain that emphasizes all that is right: view, speech, action, livelihood, thought, effort, mindfulness, and concentration.

**Hinduism:** Harmony is Vasudhaiva Kutumbakam (entire world being a single family – abandoning all dichotomies and divisions). Harmony is not just a unified system of belief encoded in a declaration of faith; it is rather an umbrella comprising the plurality of religious phenomena originating from the Vedic tradition. It includes conglomeration of a wide spectrum of laws and morality based on karma (action), dharma (righteousness conforming the regulatory order of the universe), sanskar (acculturation), and societal norms. All human beings are divine; their unity of existence with love is enriched through satya (truth), ahimsa (non-violence), asteya (non-stealing), aparighara (non-possession), santosh (contentment), and tapas (control, austerity and penance).

**Christianity:** Harmony promotes peace through benevolence by sharing the faith with others in addition to pardoning those who disrupt the peace. It is to love God, love oneself, and love all in the course of righteousness. The restrictive character of general guiding principles of harmony is recognized in all religions, most clearly in Christianity, in its 10 Commandments as the Moral Constitution of the Holy Scripture.

**Islam:** Harmony is faith in humanity recognized as one family. It is faith upon one God and having common parents, Adam and Eve, which is a great motivation for all human beings to live together with peace and brotherhood. It is not to hurt anyone whether through words or deeds; it works for the benefit and happiness of God's creatures.

**Baha’I Faith:** Harmony is a pursuit for world peace embracing collective security for the establishment of permanent peace. Harmony opposes any distinction among the people on the basis of caste/ethnicity, race, color, sex, culture, and region, etc.

Harmony can be identified in the religions as with one God (monotheism in all its forms), as and with great number of Gods (polytheism in all its forms, for example – Hinduism and etc.). In addition, one of the deepest senses of harmony is control and self-restraint, which curb the extremes, excessive and unbridled.

Fruits of harmony may vegetate in a civilized world with the concept of tolerance for peace and non-acceptance toward conflict, tension and war. Teaching of harmony is an invaluable guideline to develop harmonic mind, harmonic behavior, and harmonic thinking for all as the first condition for world peace. Harmony needs to begin at home, work and community; it is required in the society, in the nation, and on the earth. The fusion of social democracy in the countryside and market economy in the urban centers may soon be a role model for universal harmony, no less so for socially, culturally, economically and politically sensitive and conflict-prone countries in the world.

Harmony is, of course, a moral law which is continuously enriching through the beliefs, spirit and interfaith, and welfare of human beings. Seeds of world peace rise only in the soil of universal harmony, which sprout up when like-minded individuals and/or institutions work together on a common platform of *the ABC of Harmony*: [www.peacefromharmony.org/?cat=en\\_c&key=478](http://www.peacefromharmony.org/?cat=en_c&key=478).

*The ABC of Harmony* is the first book of active peacemakers in world history and the first global textbook on social harmony for all nations, governments, presidents, and the United Nations. It is for harmonious education and harmonious civilization for behavioral change. It focuses on love, justice, freedom, brotherhood, happiness, and any other universal value. It refutes disharmonious and violent consciousness and mentality. It promotes harmonious peacemaking in order to resolve armed conflicts in the 21<sup>st</sup> century. It allows for nonviolent and

peaceful solution to any global problem of humanity and it denies the possibility of war. It lifts the culture of peace to a new height. It enables the mainstream of global peacemaking interests, human survival, and sustainable peace development. It provides a turn from the history of perpetual wars to the history of eternal peace in human history.

The principles of religious harmony above are the intuitive and spontaneous rules of the interfaith harmony, which remained very limited by its character in the past. *The ABC of Harmony* is the first principle of conscious and scientific interfaith harmony in the 21<sup>st</sup> century and for future.

**Bishnu Pathak**, PhD; Hindu-Buddhist faith,  
Board Member, TRANSCEND Peace University,  
GHA Chief Coordinator: GHA Petition to the UN for Total Disarmament  
([www.peacefromharmony.org/?cat=en\\_c&key=529](http://www.peacefromharmony.org/?cat=en_c&key=529)),  
GHA Ambassador of Peace and Disarmament from Harmony  
([www.peacefromharmony.org/?cat=en\\_c&key=532](http://www.peacefromharmony.org/?cat=en_c&key=532)),  
Convener, TRANSCEND International (South Asia),  
Director, Peace and Conflict Studies Center (PCS Center).  
**Address:** P. O. Box 11374, Sokedhara  
Kathmandu, Nepal  
**Phone:** +977 1 4650696  
**Mobile:** +977 9841 345514  
**Web:** [www.transcend.org](http://www.transcend.org), [www.cscenter.org.np](http://www.cscenter.org.np),  
[www.insightonconflict.org/conflicts/nepal/peacebuilding-organisations/pcsc/](http://www.insightonconflict.org/conflicts/nepal/peacebuilding-organisations/pcsc/)  
**E-mail:** [pathakbishnu@gmail.com](mailto:pathakbishnu@gmail.com)  
24/01/13

Julia Budnikova

## Nicholas Roerich on Interfaith Harmony and Common Principles of Spiritual Teachings

The world famous Russian philosopher and artist Nicholas Roerich (1874–1947) was one of the pioneers in considering interfaith ideology as a concept full of harmony. He had to live and work in different countries, collaborating with people of diverse faiths. In 1924 he created a significant series of paintings named «Banners of the East» that consisted of 19 works. 13 from them are published in the GHA Interfaith Harmony project.

The sacred images of spiritual masters of varied epochs and folks, who became founders of World Religions, appear before spectators on these paintings. This artistic work mirrored creative, scientific, and man's credo of the great humanist. It's interesting to point out that if we range "Banners of The East" in the particular order they'll compose doubled rainbow's spectrum. Discussing aesthetic level of comprehension this phenomenon underlines the artist's believe that emanations of spiritual life in different cultures are mutually supportive and stay in the polyphonic harmony. Compositional and semantic center of the cycle is the painting "Mother of the World." This image, which is found under various names in different religions, represents the secrecy and height of the Truth, the source of everything in the universe. It can also be viewed as an embodiment of Harmony.

All the works of Nicholas Roerich are permeated by several main ideas. First of all the foundation of each of the World Religions is formed by highest spiritual knowledge common to all the humanity. Secondly, humankind can evolve and overcome the severe crisis that affects its political, economic, and social life as well as psychological stability of the society as a whole and its separate members only by means of serving to the highest powers. This service is carried out through religious practices and elaboration of religious consciousness.



Four members of the Roerich family contributed to the idea of interfaith harmony. They dug for common roots of all the religious doctrines, and tried to reveal, clarify and explain this implicit truth. They committed to promotion of the highest moral samples given by representatives of various religions, the samples that could brotherly unite people with different cultural background. As a result of this long-term activity the first in the world history international treaty on the protection of the cultural heritage was signed down. It was named Roerich's Pact. Helena Roerich wrote 17 books of "The Living Ethics" presenting the synthesis of eastern and western spiritual knowledge. George Roerich revived in Russia Buddhist studies and Vedas research in the end of 1950<sup>th</sup> after national school of Oriental studies had been totally destroyed by Stalin's regime. Smaller son of the Roerichs Svetoslav was Russian and Orthodox by birth but India with its ancient culture and rich spiritual tradition became his second motherland. He depicted Indian peoples and varied terrains of this country on numerous paintings.

How did Nicholas Roerich seek for spiritual basics of interfaith harmony? We can find the best explanation in his own words quoted below.

*«The upper portion of the Buddhist banners bear the cross-shaped spear, disk, crescent and lotus-petals. Are not the emblems of all teachings intertwined upon one flagstaff? In these reminders of the symbols of the elements of Nature every one will find an image near to him.*

*Upon the icons and ornaments of Tibet often is found, glowing with precious stones, the image of the fish — that happy sign — the same found upon the walls of the Roman catacombs. In one conception is united the Buddha's "Wheel of life," the Circle of the "Elements forming the mystery" of the Christian church and the "Wheel of Ezekiel." The many-eyed seraphim and multiple eyes of the Luminous Mother of the World penetrate equally into the recesses of the soul.*

*In the cults of Zoroaster there is represented the chalice with a flame. The same flaming chalice is engraved upon the ancient Hebrew silver shekels of the time of Solomon and of an even remoter antiquity. In the Hindu excavations of the periods from Chandragupta Maurya, we observe the same powerfully stylized image. Sergius of Radonega, laboring over the enlightenment of Russia, administered from the flaming chalice. Upon Tibetan images, the Bodhisattvas are holding the chalice blossoming with tongues of flame. One may also remember the Druid chalice of life. Aflame, too, was the Holy Grail. Not in imagination; verily by deeds are being interwoven the great teachings of all ages, the language of pure fire!*

*It has long since been said, "Faith without deeds is dead".*

*Buddha pronounced three paths: the long way of knowledge, the shorter way of faith, and the shortest way — through action.*

*David and Solomon also glorify the strivings of labor. The Vedanta extols the manifestation of works. Verily, in the foundation of all covenants, action is placed foremost. This is the creative fire of the Spirit.*

*Are the symbols of the Hindu Trimurti alien to the Trinity? Does the Buddhist Tree of Wishes, hung with the objects of all desires, not respond to our conception of the Christmas Tree? What of the details of the arrangement of the temple altars? What of the ascetics and hermits, who buried themselves in their stone coffins? What of the image-lamps and the fires of conjurations; the wreaths and candles of heartfelt prayer, flung upon the bosom of the Ganges? And the birch of Trinity, the musk and incense? And the wrought gem-bedecked vestments? And the stones flung at Buddha by his closest kin — are they not like the stones of Stephen? Verily, not by accident have Buddhist legends been carved upon the frescoes of the Campo Santo in Pisa. Profound in its significance too is the Moslem legend telling of the visitation of the mother of Jesus to the mother of Mohammed before the birth of the Prophet...*

*In Jeddah, this gateway to Mecca, the Mohammedans especially venerate and guard the so-called Tomb of Eve. And it is the same Archangel Gabriel — he of the Old and New Testaments — who upon Mount Hira bade Mohammed commence his preaching — the same one!*

*Mogul queens bore the revered title of Miriam. Miriam, Mary, Mother of the World. From times immemorial have the most ancient forgotten temples extolled the anticipation of the new epochs. (delete line below)*

*In the ancient city, Kish, has recently been discovered the Temple of the Mother of the World.*

*Sarnath and Gaya, the scenes of Buddha's personal achievements, are fallen in ruins, now only the goal of pilgrims. So too, Jerusalem. "Because Jesus himself witnessed that the prophet is without honor in his own country."*

*According to the legend, Buddha's initiation was performed in the presence of the High Ones. The site of initiation is called "the holiest stupa" but its location is not disclosed. The sites of Buddha's achievements on the Ganges are known, as well as the scenes of the birth and death of the teacher — in Nepal. According to some indications the initiation was performed farther north — beyond the Himalayas, because Buddha came down from the north for the performance of his works. But where was Jesus until his thirtieth year? Who knows those haloed retreats? Whither lies Korya-Morya? Shall they be revealed? The legendary mountain Meru, according to the Mahabharata, and the equally legendary height Shambhala in Buddhist teaching, both lay in the north and served as the summit for initiations. And not everywhere until the appointed date, can the details of these places of high knowledge be told.*

*Wise intercourses—one sees clearer from above. Instead of petty quarrels of denunciation, history recalls to us truly international ties...» (N. Roerich. Altai-Himalaya. [www.roerich-izvara.ru/eng/roerich/roerich-altai-himalaya.htm](http://www.roerich-izvara.ru/eng/roerich/roerich-altai-himalaya.htm))*

The modern researcher and thinker S.Y. Klyuchnikov who works in The Institute of Asian and African countries (Moscow) speaking at the “Roerich’s Heritage” conference in 2005 expressed the right thought:

*“Each of the world cultures – Indian, Chinese, Japanese, Near East-Islamic, classical European (Catholic) and Russian (Orthodox) – include two systems: the system of moral and spiritual ideals, and the practical system of upbringing and perfection of a man. Each of these cultures developed its own way of solving historical problems and crisis management that were quite effective in the historical period when there had been no signs of globalization. But nowadays any independent attempt to solve the above mentioned problems wouldn't be successful. In the face of a common danger the best forces of humanity have to unite. This union must begin with interaction between intellectuals, scientists, religious and spiritual leaders - rulers of the minds so to say. It should result in working out a plan of collaboration, that'll lead to creation of the general moral and practical ideology confronting to the crisis.”*

One of the brightest examples of such collaboration represents the world textbook entitled “*The ABC of Harmony*”. 76 co-authors from 26 countries of GHA conjoined in the “Peace from Harmony” community took part in this project. [www.peacefromharmony.org/?cat=en\\_c&key=478](http://www.peacefromharmony.org/?cat=en_c&key=478).

The best traditions established by our outstanding compatriots are being prolonged thanks to projects similar to the Interfaith Harmony Educational Project of Global Harmony Association”. They help to unite progressive forces targeted to tackle global challenges and form new vision that is capable to create the New Era’s Man, endowed with cosmic consciousness, and guard the Earth from destruction.

**Julia Budnikova**, Orthodox Church, was graduated from the Philological Faculty of St. Petersburg’s State University in 1988. She currently holds the position of Deputy Director for exhibition work at the Roerich Family Museum and Institute, St Petersburg, Russia.

Coauthor, *The ABC of Harmony*: [www.peacefromharmony.org/?cat=en\\_c&key=478](http://www.peacefromharmony.org/?cat=en_c&key=478).

Address: St Petersburg, Russia

Web: [www.roerich.spb.ru](http://www.roerich.spb.ru)

E-mail: [jb@roerich.spb.ru](mailto:jb@roerich.spb.ru)

Leo Semashko

Dalai Lama: Need for Religious Harmony  
(Published: *The ABC of Harmony*, 2012, p. 250-251)

His Holiness the XIV<sup>th</sup> Dalai Lama (born July 6, 1935) is the spiritual leader of Tibetan people, Buddhist of Tibet and adjacent regions. He won the Nobel Peace Prize in 1989. He is the best known for his commitment to interreligious harmony and his qualities of noble character and spiritual wisdom. The most characteristic event in this respect was his public talk on "Bridging the Faith Divide" at Chicago University, July 17, 2011. We will try here to describe briefly its basic postulates, using [<http://dalailama.ru/news/722-dalai-lama.html>].

In his early book "Toward a True Kinship of Faiths" Dalai Lama wrote about his trip in 1956 in Chennai (then Madras): "There I was first directly exposed to people, and to a movement, that attempted to bring together the wisdom of the world's spiritual traditions as well as science. I felt among the members a sense of tremendous openness to the world's great religions and a genuine embracing of pluralism. When I returned to Tibet in 1957, after more than three months in what was a most amazing country for a young Tibetan monk, I was a changed man. I could no longer live in the comfort of an exclusivist standpoint that takes Buddhism to be the only true religion."

His Holiness said that most religions believe a distinction needs to be made between the sinner and the sin. While the sin has to be opposed, the sinner needs forgiveness, he said.

His Holiness said that at different times different teachers have highlighted the wonderful spirituality, the message of harmony. He said it was understandable when there was conflict over money or power, but conflict over religion was not understandable because the very purpose of religion was to create inner peace. He added that most conflicts in the name of religion are actually not based on religious faith but because of power and money.

His Holiness said most of the misunderstandings over religion are on account of the lack of awareness. He cited his own experience to substantiate this. He said when he was in Tibet, he used to feel that his religion, Buddhism, was the best religion and that other religions were "so so." He added that it was only after coming over to India and interacting with people of other traditions, like the late Thomas Merton and Mother Teresa, that he had come to appreciate the significance of all faiths. He recalled his conversation with Islamic scholars who said the accurate definition of Jihad was attacking one's own destructive emotion.

His Holiness said all religions promoted the same practice of love, forgiveness, tolerance, self-discipline, moral principle, truth and justice. He said there was philosophical difference among religions, pointing out that all major religious traditions could be divided into two categories: theistic and non-theistic religions.

His Holiness then highlighted the need for several religious traditions in this world. He said the concept of One Religion, One Truth may seem to contradict the concept of Several Religions, Several Truths. However, he said that at the individual level having clarity with One Religion, One Truth may be more suitable, while to a community and the society as a whole, Several Religions, Several Truths were something that nobody could ignore.

His Holiness then explained the development of human society. Initially, people depended on prayers to resolve all problems. He talked about Tibetans depending on rituals for solution to their problems. Gradually, with scientific and technological development, people began to repose faith in science. His Holiness said that towards the end of the 20<sup>th</sup> century people began to realize that material development alone did not have all the answers. This is indicated by people who succumbed to such addictions as tranquilizers, alcohol and drugs, particularly among the younger people.

His Holiness also expanded on his two commitments of promotion of religious harmony (at the level of being a Buddhist monk) and promotion of human values (at the level of being one among the nearly seven billion human beings on this earth). His Holiness pointed out that he

propagated three ways of promoting religious harmony. First, by interacting with scholars of different religions whereby commonality and differences among religious traditions could be discussed. Secondly, by meeting among religious practitioners who have deeper experiences. Thirdly, organizing group pilgrimages to sacred places of different religious traditions. His Holiness gave his own experiences of implementing these three approaches.

He also talked about corruption in society becoming serious in India, China and even in the United States. He said that corruption occurred not because of lack of education but on account of absence of moral values. He said that basic human moral principles were not based on religion. He felt secular ethics could provide a solution to better human beings. He explained that his concept of secularism was along the Indian definition in that it did not mean rejection of religion but respect for all religions.

The Dalai Lama's experience in the development of inter-religious harmony has historical meaning, because without it there can not be a harmonious civilization. *The ABC of Harmony* ([www.peacefromharmony.org/?cat=en\\_c&key=478](http://www.peacefromharmony.org/?cat=en_c&key=478)) serves the development and strengthening of interfaith harmony. This world textbook creates for this harmony a single scientific and spiritual platform, which is acceptable to all religions.

**Leo Semashko**, PhD; Orthodox faith,  
Philosopher and sociologist; Global Harmony Association (GHA) Founder and President since 2005. Editor in Chief, *The ABC of Harmony*: [www.peacefromharmony.org/?cat=en\\_c&key=478](http://www.peacefromharmony.org/?cat=en_c&key=478).  
**Address:** Saint-Petersburg, Russia  
**Web:** [www.peacefromharmony.org](http://www.peacefromharmony.org)  
**E-mail:** [leo.semashko@gmail.com](mailto:leo.semashko@gmail.com)

Rudolf J. Siebert

## The Realization of Harmony in Religion, Philosophy, and Science

In the perspective of the comparative dialectical religiology, all three Abrahamic religions - Judaism, Christianity, and Islam - and the philosophies rooted in them, have taught the unlimited idea, that the Universality, determined by faith and reason, the absolute final Purpose, the Good, would be realized in the empirical world, and that indeed through a third factor, a Power, who himself posited this final Purpose, and realized it: - Yahweh, Spirit, Allah, God, Providence, Reason, Nous, Logos, the Absolute, the Unconditional, the utterly Other than the horror and terror of nature and history. Thereby in God, as the absolute Truth, and as the Coincidentia Oppositorum, these opposites, antinomies, contradictions, antagonisms, dissonances, disharmonies between the universal and the particular, between subjectivity and objectivity, would be resolved, and would be declared not to be independent, and abstract, and untrue, and would be mediated, and concretized, and harmonized in reality. Religion, philosophy, and science were three stages in the history of human reason, concerned with the realization of harmony in nature, individual, family, society, state, history, and culture.

### Moral Law

However, in the view of the comparative critical theory of religion, according to the secular modern philosophies the good, in which the final purpose of the world was posited, was apriori determined as peoples' human good, as the moral law of their practical reason. Thus, the unity or harmony did not go further than to the agreement of the condition of the empirical world and the economic, political, and historical events, with peoples' personal or social morality. Furthermore, even with this subjective limitation, the final purpose, the good remained an abstractum without determinations: as well as also that, what ought to be a duty. More closely, modern philosophers reawakened and asserted again against this harmony the opposition between universal and particular, subject and object, which had been posited as abstract and

untrue in this very harmony. Consequently, the modern philosophers determined the harmony as something merely subjective: as something, which only ought to be; i.e. as something, which at the same time had no reality; as something merely believed in or hoped for, and which had merely subjective certainty; which had no truth and reality; to which was not fitting and did not belong that objectivity, which once in the great world religions corresponded to the Idea: the reason determined universality; the final purpose of the empirical world of nature and history; the good posited by the Creator and Redeemer God, by Reason and Providence. If modern secular philosophers tried to cover up this contradiction and disharmony, by moving the realization of the Idea, the final purpose, the good, the harmony, into the time, into the future, then such sensuous condition as the time was rather the very opposite of a solution of the contradiction, and the corresponding representation of analytical understanding, the infinite progression into the bad infinity was immediately nothing else than the perennially posited contradiction and disharmony: the bad infinity, instead of the good Infinity, of which the world religions once spoke .

### **Dualism**

According to the comparative critical religiology, in every religious or secular dualistic system, the fundamental deficiency showed itself through the inconsequence, to unite and harmonize that, what a moment before had been declared as independent, i. e. as incompatible and being unable to be harmonized. All dualisms exclude harmony by definition. As at this moment the united was declared to be the true and real, so right away was declared to be true, that both moments, which had just been denied in their union their being for themselves, had only truth and reality in such a way, as they were separated. In such modern dualistic philosophies, the simple consciousness was missing, that with this going back and forth itself each of these single determinations were declared to be unsatisfactory. The deficiency consisted in the simple inability, to bring two thoughts together: and there were only two forms at hand. It was, therefore, the greatest inconsequence on one hand to concede, that analytical understanding could only recognize appearance, and on the other hand to assert this knowing as something Absolute, by saying that human knowledge could not possibly go further, and that this was the natural, absolute limit and barrier of human knowledge: agnosticism.

### **Natural Things**

In the perspective of the comparative, dialectical religiology, the natural things, - the rocks, the plants, and the animals - were all limited. They were only natural things, in so far as they did not know anything of their universal limit, and insofar as their determinateness was only a limit for the human observers, but not for them. Something was felt, or known, as limit or deficiency only, insofar as one was at the same time beyond it. The living things, the animals, have the privilege of pain before the inanimate, lifeless objects in nature. Even for the animals a singular determinateness became the feeling of a negative, because they have, as being alive, in themselves the universality of liveliness, which went beyond the singular existence, and because they maintained themselves in the negative of themselves, and because they felt this contradiction as existing in themselves, and because they had to harmonize it, if they wanted to survive in the world. This contradiction was in the living things only in so far as both were in the one subject: the universality of their feeling of life, and the singularity which was negative against that universality. Limit, or lack of human knowledge, was likewise only determined as limit, lack, and deficiency through the comparison with the at hand idea of the universal, of a whole, of something complete. It was, therefore, only a lack of consciousness, not to recognize, that precisely the mark, sign, description of something as finite or limited contained the proof of the real presence of the Infinite, the Unlimited, and that the knowledge of limit could only be, insofar as the Unlimited was on this side in human consciousness. All great world religions knew this: the Infinite was in the finite, and the finite was in the Infinite, and both were in fundamental, true and real harmony, as the basis of all other possible harmonies in nature, man,

family, society, state, history and culture. In a truly free disposition remained the notion of the Infinite as the consciousness of the finality of finite life, of all earthly happening, and of the unchangeable abandonment of man, and saved civil society from an idiotic optimism, and from the inflation of its own knowledge as a new religion.

### **Empiricism**

In the view of the comparative critical theory of religion, the secular modern moral philosophy, which had tried to replace the moral theology of the world religions, and which did not recognize any higher divine Instance before or beyond nature, and which grounded all norms and values in nature or man, and which thus could not be ultimate, and which therefore had motivation problems from the start, has so far had no real influence on the positive sciences, not even on the new futurology. It left the categories and methods of the positive sciences completely undisputed. If sometimes moral-philosophical sentences appeared in the beginning of books of the otherwise supposedly value free social sciences, it became obvious only too soon, that those sentences were only superfluous decorations, and that the same empirical content would have appeared, if the former had been missing. As far as the comparison between those secular moral or ethical philosophies and the metaphysicizing empiricism was concerned, the impartial, unprejudiced, uninhibited empiricism admittedly held on to sensuous perceptions, but it allowed likewise a spiritual reality, a super-sensuous world, however its content may be determined and structured: no matter whether it originated from thought or from the imagination. According to its form this content had the countersignature, like the other content of the empirical knowledge, from the authority of the external perception: in intellectual and spiritual authority. But the reflecting empiricism, which made the consequence into a principle for itself, fought and struggled against such dualism of the ultimate, highest content, and negated the independence of the thinking principles and of a spiritual world developing in it. The modern materialism, naturalism, positivism, and atheism was the consequent system of empiricism. The world religions could ally themselves with each other, in order to enter discourse with each other in the public sphere between civil society and state, and with the expert cultures devoted to this consequent system of monistic empiricism, because there will be no peace and harmony among the nations without peace and harmony among the world religions, and there will be no peace and harmony among the world religions without a conversation among them, and there can be no discourse among them, and between them and the secular culture, including philosophy and positive science, without mutual knowledge. The main task was to keep this discourse open in the public square, and not to close it up fundamentalistically on the religious side, or materialistically, naturalistically, positivistically, agnostically, or atheistically, on the secular side.

### **Thought and Freedom**

According to the comparative, dialectical religiology, the secular, modern, moral philosophy opposed to this reflecting empiricism the principle of thinking and freedom as such, and connected itself with the first form of impartial, unprejudiced, uninhibited empiricism, without stepping the least out of its own general principle. The one side of the moral philosophy's dualism remained the world of perception and of the analytical understanding reflecting on the former. This world was admittedly presented as a world of appearances. But this was a mere title, a merely formal determination, because the source, content, and mode of consideration remained completely the same. The other side was to the contrary the independence of the self-comprehending thought, the principle of freedom, which the secular moral philosophy had in common with the usual modern metaphysics as an identity philosophy, but emptied out of all content, and unable to create a new one. This thinking, which in the moral philosophy was called reason, was as being robbed and deprived of all determinations, relieved of all authority. The main effect, which the modern moral philosophy had had, was to have awakened in people the consciousness of the absolute internality of man: his conscience. In spite

of the fact, that this absolute internality was, because of its abstraction, unable to develop itself out of itself to anything, and to produce any determinations, neither knowledge nor moral laws, it refused, nevertheless, simply, to let anything take place in itself, and to consider anything as valid in itself, which had the character of externality. According to the modern moral philosophy, the principle of independence of reason, its absolute independence in itself, had to be seen as the universal principle of all modern philosophy, as well as one of the prejudices of the modern time. In the process of modernity, autonomous reason opposed revelation more and more, and it was the task of a rational theory of religion, to overcome the deepening dissonance between them, and create harmony between them, as basis of the reconciliation and harmonization of all the other antagonisms of modern and post-modern civil society.

### **Finitude**

In the perspective of the comparative critical theory of religion, modern secular philosophy had the great negative merit, to have made valid the conviction, that the determinations of analytical understanding in the positive sciences, belonged to finitude, and that a knowledge, which moved inside them, could not come to the Truth in the emphatic sense as once understood and comprehended by the world religions. However, the one-sidedness, abstractness and untruth of modern philosophy consisted then in the fact, that the finitude of those determinations of analytical understanding was posited into that, that they merely belonged to peoples' subjective thinking, for which the Thing-in itself - i.e. God, Freedom and Immortality, imageless, was to remain an absolute Beyond, or imageless, nameless and notion less Other than nature and history. What people were thinking was false, simply because they were thinking it. However, the finitude of the determinations of analytical understanding did not only lay in their subjectivity, but they were rather finite in themselves. The critical theory of religion tries to reconcile and harmonize Moses' second and third commandment - not to make images or name the Absolute, on one hand, and the modern enlightener Immanuel Kant's prohibition against analytical understanding penetrating the sphere of the Thing-in -itself, on the other.

### **Historical Narrative**

According to the comparative dialectical religiology, a further deficiency of modern philosophy was, that it gave only a historical description of thinking, and a mere narrative of the moments of the history of human consciousness and reason. It must be admitted, that this historical narrative was correct in its main points. However, modern philosophy did not speak of the internal necessity of the content, which was thus grasped empirically in and through the historical narrative. Then modern philosophy presented as the result of the historical narrative of the different stages of the human consciousness, and of the reflection about it, that the content of which people knew, was only appearance. This result was correct insofar, as the finite thinking dealt admittedly only with appearances. But this stage of appearance was not yet all there was, but there was still a higher land of longing and of the future, a concrete utopia, of which the world religions once knew, but which remained for the modern critical philosophy merely an impenetrable and inaccessible Beyond. Finally, the philosophical narrative of the history of human reason talked always only about that, what had been true for others in the past, but what was no longer true for the people of today, and of tomorrow. What religious people once called emphatically the Truth, which would liberate, if it was done, or what metaphysicians called emphatically the truth as the identity of a thing with itself, has been replaced in modernity by the correctness of protocol sentences in the different natural and social science. However, even most successful, correct scientific sentences may not be true in the religious or metaphysical sense of the Truth. That became relevant, whenever religious people and scientifically enlightened people met with each other in culture wars in the modern public sphere between society and state, and found out, that harmony between them was hard to be achieved and realized for whatever rightful political, or policy purpose.



### **Moral Politics and Policies**

In the view of the comparative critical theory of religion, seen from the standpoint of modern, sophisticated empiricism, materialism, positivism, naturalism, agnosticism, or atheism, no moral politics or policies could be derived. Considered purely scientifically, hate was in spite of all socio-functional differences, no worse than love, disharmony no worse than harmony. There was no logically cogent argumentation, justification, or reason, why a man should not hate, if thereby he did not have any disadvantages for himself in the family, in the civil society, in the public sphere, in the state, or in history. The positivist or naturalist could say with Orwell or Huxley: war was as good or as bad as peace; freedom was as good or as bad as slavery, feudalism, or capitalism as private appropriation of collective labor, or as any other system of oppression and exploitation; disharmony was as good as harmony. This was correct, because positivism or naturalism could not justify exactly and precisely, why people should not hate, if that was fun for them. Positivism or naturalism found no Instance, which would transcend human beings, family, civil society, public square, state, history, or culture, and which could differentiate between helpfulness and greed for profit, between goodness and cruelty, between avarice and giving oneself to others, between the attitude of having and being, between the striving for disharmony or harmony. Also the logic remained mute: it gave no higher rank to the moral disposition. All attempts of the past 200 years, to justify morality instead through the elevation toward a concrete Beyond, as it had happened in the world religions in different forms, rather through earthly prudence, have rested on harmonistic illusions. All what in history had hung together with morality, went in the final analysis back to the world religions and to theology. All morality was grounded in good religion and theology. Politics and policies, which did not preserve in themselves theology, if also only in a most unreflected way, remained, no matter how skillful they were, in the last analysis mere business. Here theology did not stand for the science of the Divine, or even for the science of God. Here theology rather meant the consciousness, that the world was appearance; that it was not the absolute Truth, the Ultimate Reality. Theology was the hope, that the massive injustice and the consequent disharmony, through which the world was actually characterized, would not remain, and that they may not be the last word of history. Theology was the expression of a hope, or better still of a longing, that the murderer may not triumph over the innocent victim. That hope and longing was originally Jewish, Christian, and Islamic, and religious in general. Also the Jew, the Christian, and the Muslim, and every genuine religious believer hoped and longed for absolute justice-the punishment of the evil people, and the happiness for the good people,- as well as for unconditional love, and the consequent ultimate harmony of all life in nature and history, and beyond.

**Rudolf J. Siebert**, (b. 1927), Roman Catholic faith, Professor of Religion and Society, Department of Comparative Religion, Western Michigan University, Kalamazoo, Michigan, USA. He develops the Critical Theory of Society and Religion presented in about 300 scientific publications in 12 languages, including 28 books and 35 chapters. He is the leading researcher of the world religions Golden Rule as the first conscious principle of social harmony. Director of the two international courses: 1. "Future of Religion" in Dubrovnik, Croatia since 1975, and 2. "Religion in Civil Society" in Yalta, Crimea, Ukraine since 1999. He is the "Peace from Harmony" and GHA founder in 2005. Roman Catholic Faith. He has the GHA highest Honorary Title: World Harmony Creator.

Coauthor, *The ABC of Harmony*: [www.peacefromharmony.org/?cat=en\\_c&key=478](http://www.peacefromharmony.org/?cat=en_c&key=478)

**Web**: [www.rudolfjsiebert.org](http://www.rudolfjsiebert.org), [www.peacefromharmony.org/?cat=en\\_c&key=51](http://www.peacefromharmony.org/?cat=en_c&key=51)

**E-mail**: [RSieb3@aol.com](mailto:RSieb3@aol.com)

January 6, 2013

Charles Mercieca

## World Religions and Interfaith Harmony

The best experience we can possibly have on earth is found in inner peace that emanates from our ability to live harmoniously with ourselves and with others. Every major religion in the world has plenty to offer in this regard. They all attach great importance to the spiritual aspects of life over the material ones. In fact, a careful study of every single human that exerted great influence on the world at large demonstrates that the source of harmony may be traced to our detachment from the material things of this world.

### Global Religious Leaders

Gautama Siddhartha was a very rich man. He had everything he could possibly need in life except for the most vital item, which is happiness. After a number of years he realized that the more one is attached to the material things of this world, the more difficult it is for that person to develop inner joy. Hence, he gave everything he had to the poor and embarked upon a monastic type of life that elevated his spirit to a higher level of existence where he could find true happiness. He later became known as Buddha, meaning Enlightenment.

Since then he had millions of followers around the world commonly known as **Buddhists**. Years later, Jesus of Nazareth spent the latter part of His life teaching the observance of the Ten Commandments, which were meant to attach great importance to the welfare of our neighbor. Jesus exhorted his disciples to become an integral part of God's family through the practice of virtue and the renunciation of vice. Over the centuries many of his followers established monasteries where they seek to denounce all earthly pleasures.

Emphasis is made on prayer and meditation, two elements that are bound to bring humans closer to God. This is, in essence, what **Christianity** is all about.

Several centuries later, Islam came into existence through the preaching and teaching of Prophet Mohammad who had demonstrated great respect toward Jesus of Nazareth as revealed in the Koran. He exhorted his followers to view God as their Father on whom they depend for everything conceivable in life.

Today, this holy and good prophet has millions of followers around the world. They are very concerned with the welfare of all humans whom they seek to help even at the cost of self-sacrifice. Needless to say, in everything they do they try to seek for inner satisfaction and happiness. In other words, Islam attaches the source of peace among all nations through harmonious relationship with all people from every walk of life and profession. Those who profess faith in Islam are commonly known as **Moslems**.

### Constructive Contributions

India is mostly known for giving birth to **Hinduism**. Most of the leading adherents to this faith have provided excellent spiritual guidance that focuses on the inner self, which represents the spiritual aspect of the human life. One of the best books that represent the essence of Hinduism is the Bhagavad-Gita. Like we notice in the writings of Buddhism, Christianity and Islam we find in Hinduism a notable importance attached to the spiritual element of the human life. We notice here interfaith harmony that leads eventually to everlasting peace.

Last but not least, we have Judaism, which may be viewed as a very important religion in the sense that its concept of God was adopted in both Christianity and Islam. Besides, both of these religions carry great respect for Judaism that has emphasized the importance of peace and harmony among all people. The most authoritative book in **Judaism** is the Old Testament, which is full of wisdom and inspiration. These five major religions that we outlined provide us with very similar constructive statements.

In spite of the diversities we notice among these five major religions in the matter of prayer, meditation and worship, the basic philosophy in each one of them remains the same: **the**

**creation of a peaceful and harmonious society.** As many ascetical writers tell us, if we were to achieve a peaceful and harmonious society in the world, numerous conflicts and wars will become a thing of the past. Besides, many writers tell us that all people of all nations yearn for the promotion of peace and never of war.

In conclusion, the major religions in the world are all contributing toward the creation of interfaith harmony that enables everyone to feel secure and peaceful. Regardless of the history of conflicts and wars the world experienced for the past several centuries, **interfaith harmony** will eventually bring an end to global conflicts sooner or later. To this end, we may concentrate on creating a new generation of peace that is characterized by harmony based on mutual love and respect. In view of this, we hope and pray that all people will start doing everything based on a mutually beneficial basis.

On the other hand, the contributions of world religions to interfaith harmony are not enough, evidently, because this harmony has not been reached between them in more than a thousand years of co-existence. This means that interfaith harmony is in need of a new and additional base, especially in the modern era of globalization. Global Harmony Association suggests that such ground in the 21<sup>st</sup> century can be *the ABC of Harmony* ([www.peacefromharmony.org/?cat=en\\_c&key=478](http://www.peacefromharmony.org/?cat=en_c&key=478)) through the global harmonious education of all believers in this ABC and similar world textbooks.

**Charles Mercieca, Ph.D.,** Multi-faith,  
President, International Association of Educators for World Peace  
*Dedicated to United Nations Goals of Peace Education,  
Environmental Protection, Human Rights & Disarmament*  
Vice-President, Global Harmony Association  
Professor Emeritus, Alabama A&M University, USA  
Hon President & Professor, SBS Swiss Business School, Zurich  
Coauthor, *The ABC of Harmony*: [www.peacefromharmony.org/?cat=en\\_c&key=478](http://www.peacefromharmony.org/?cat=en_c&key=478)  
**Web:** [www.iaewp.org](http://www.iaewp.org), [www.peacefromharmony.org/?cat=en\\_c&key=129](http://www.peacefromharmony.org/?cat=en_c&key=129)  
**E-mail:** [mercieca@knology.net](mailto:mercieca@knology.net)  
04/01/13

Glen T. Martin

## Interfaith Harmony and the Earth Federation Movement

One of the mottos of the World Constitution and Parliament Association (WCPA) is “democratic world law is the 21<sup>st</sup> century form of love.” This declaration may initially appear strange. How can law be likened to love? But the spirit that envisions the universal rule of democratic law is the same deeper human spirit that envisions world peace or interfaith harmony. This insight goes back to the very foundations of the world’s great religions, although it has often historically been perverted through dogmatism, fanaticism, and sectarianism. The insight is found in the famous “golden rule,” it is found in the ‘mystical’ traditions of all the great religions, and it is found in the movement to establish democratic world law.

As scholar of religions John Hick shows in *An Interpretation of Religion*, all the great religions teach some version of the golden rule: “As you would that men do unto you,” says Jesus, “do also to them likewise” (Luke 6:31). This rule can be understood as a rule of prudence and mutual toleration (I would have others tolerate my faith and my religious practices) or it can be understood as a council of love (I would have others love and revere my faith and religious practices and I should love and revere theirs). Perhaps this Hadith of the Prophet in Islam puts it more clearly: “No man is a true believer unless he desires for his brother that which he desires for himself.” It is not simply toleration, according to this Hadith, but one must actually desire for others what one desires for oneself. The *Dhammapada*, expressing the compassion (*karuna*)

taught by the Buddha, declares that: “Life is dear to all. Comparing others with oneself, one should neither strike nor cause to strike.” How much has history shown that the dogmatic privileging of one’s own religious ideology to the exclusion of others promotes both striking and causing to strike?

The *Constitution for the Federation of Earth* establishes planetary democracy (and hence the equality of all and requirement of toleration as foundational) and its Article 12 proclaims the universal right of “freedom to profess, practice or promote religion or religious beliefs or no religion or religious belief.” Just as democratic law cannot deny or repress faith or religious belief so it cannot legitimately promote faith. It necessarily must leave this to the realm of the personal freedom of citizens. How, then, can the World Constitution and Parliament Association that sponsors the *Constitution for the Federation of Earth* see this document as the 21<sup>st</sup> century form of love?

The answer lies in the fact that the rule of democratically legislated law over all persons establishes equality, freedom, peace, justice, and prosperity for all human beings. What else but love can be so concerned with the welfare of all people equally? Even though the Earth Federation government must remain neutral regarding religion or no religion, the planetary community of world citizens that it establishes flourishes in the positive fullness of freedom and peace. In Christianity, Jesus says that *agape* is “like the sun and the rain,” equally falling on all people, the just and the unjust (Matt. 5:45). This is what good law does as well. Under the *Earth Constitution* such law is universal, no one is exempted. Democratic world law, therefore, is analogous to love. It not only treats everyone equally, but promotes their flourishing equally in dignity, mutual respect, and freedom, just like the spirit of *agape*.

The *Earth Constitution* expresses its own golden rule in its affirmation of the principle of unity in diversity. Interfaith harmony cannot exist through an affirmation of diversity alone. In unredeemed diversity lies the conflict of seemingly incommensurable religious perspectives, a fragmentation in which each claims to possess the one true faith. Harmony only arises when diversity is embraced by a unity affirming and encompassing the diversity without negating it. Spiritually that unity may be the spirit of love (*agape*) or compassion (*karuna*), but institutionally that unity is provided by democratic world law, which we have seen is analogous to love. Within the Preamble we find:

Conscious that Humanity is One, despite the existence of diverse nations, races, creeds, ideologies and cultures and that the principle of unity in diversity is the basis for a new age when war shall be outlawed and peace prevail; when the earth's total resources shall be equitably used for human welfare; and when basic human rights and responsibilities shall be shared by all without discrimination...

Interfaith harmony indeed envisions a new age because, like the Sufi tradition within Islam, it understands a deeper spirit and spirituality that does not contradict the beliefs and rituals but removes their apparent incommensurability with other religions and other faiths. Just as Mahatma Gandhi declared of Hinduism, interfaith harmony understands that the truth of our human situation can be expressed in a multiplicity of metaphors, symbols, and doctrines. We must “cling to truth” (*satyagraha*) in Gandhi’s understanding, not claim its absolute possession. There is no longer any such thing as the “one finally correct” formulation of truth. Language and history embrace a multiplicity that must be embraced in a new unity that does not destroy the multiplicity but harmonizes it. The spirit of the *Earth Constitution*, expressed in its Preamble, embodies this understanding.

This understanding may be embodied in ideals expressed within the *Constitution for the Federation of Earth*, but it is also a living reality with the World Constitution and Parliament Association that promotes the *Earth Constitution*. Our worldwide membership from most of the countries on Earth includes people from many religions and spiritual traditions as well as many from around the world people who do not profess any religion or spiritual tradition. In Thailand

and Nepal there are many Buddhists (and non-Buddhists) who support our work, in India many Hindus (and non-Hindus), in Ghana, Togo, and South Africa, many Christians (and non-Christians), in Libya, Turkey, and Bangladesh, many Moslems (and non-Moslems).

Our work for democratic world law within the Earth Federation Movement affirms the inclusive principle of unity in diversity throughout all the domains of human life, as well as harmony with our planetary environment. Our work has long interfaced with religions and spiritual movements that are explicitly founded on the principle of unity in diversity and recognize the need for world political unity and world government. There are many Baha'is who support us, for example, understanding that their founder, Baha'u'llah, declared that the rulers of the Earth must together "consider such ways and means as will lay the foundation of the world's Great Peace among men." In Lucknow, India, we have worked closely with the City Montessori School (CMS) and its founder/manager, Dr. Jagdish Gandhi, of the Baha'i faith, who, as a Baha'i, promotes the unity of God speaking through all the world's great religions as well as world political unity under a democratic world parliament.

In India, WCPA has worked closely with the International Society for Intercultural Study and Research (ISISAR), headed by Dr. SantiNath Chattopadhyay and centered in Kolkata. ISISAR has published scholarly volumes on religious thinkers such as Vivekananda and Rabindranath Tagore. Vivekananda attended the initial great World Parliament of Religions in Chicago in 1893 and was a leader in the movement for interfaith harmony, as was Tagore whose mystical religious poetry reflecting interfaith harmony has had a worldwide impact. Both Vivekananda and Tagore promoted world political unity as well. Members of ISISAR understand these connections, as does WCPA. Interfaith harmony and global political harmony are two sides of the same coin.

We have also long worked closely with World Union and the Sri Aurobindo Movement, centered in India, for their followers understand Sri Aurobindo and The Mother's vision of a unified political and spiritual world system. During the three decades following 1970, Samar Basu and A. B. Patel, both leaders in World Union, worked closely with leaders of the World Constitution and Parliament Association. Patel was Co-President of WCPA for many years until his death. He was also General Secretary and Treasurer of World Union International Center, Sri Aurobindo Ashram, Pondicherry. Like Basu, he participated in the first three Constituent Assemblies in 1968, 1977 and 1979 during which world citizens from many countries worked together to envision, write, and promote the *Earth Constitution* to all the governments of Earth. Patel presided over the signing of the *Earth Constitution* at the Second Constituent Assembly in Innsbruck, Austria in 1977 and was its very first signatory. He was also elected as Parliamentary Speaker for the first session of the Provisional World Parliament held under the authority of the *Constitution* that took place in Brighton, England in 1982.

In Japan, WCPA has long worked with the Oomoto Religion centered in Ayabe and Kameoka. The founders of Oomoto affirmed multiple revelations from the creative source of Being and the need for the political and spiritual unity of human beings on Earth. Their organization called *Jinrui Aizenkai* or Universal Love and Brotherhood Association (ULBA), founded in 1925 by Onisaburo Deguchi, co-Founder of Oomoto, works to bring not only peace and love through its multiple chapters around the world but also political unity in diversity for our planet. WCPA former President, Dr. Terrence Amerasinge (1917-2007), was the director of the ULBA chapter in his home country of Sri Lanka. In January 2005, I traveled with Dr. Amerasinghe on behalf of ULBA down the coast road south from Colombo, Sri Lanka, to assess the damage from the terrible tsunami so that the Sri Lanka ULBA chapter might provide effective help. A number of members of the Oomoto religion in Japan, like members of WCPA, also work in cooperation with the World Federalists of Japan, another organization that understands the need for democratic world government.

From the above it should be clear that WCPA not only supports the principle of interfaith harmony but is itself a living embodiment of the principle of unity in diversity that is behind the *Earth Constitution* and the authentic quest for interfaith harmony. But interfaith harmony is not a

principle opposed to the potential social harmony of those who are skeptical of any expression of faith and prefer to claim they have no religious beliefs or faith. In my travels in support of the many diverse chapters of WCPA around the world, from many diverse nations, cultures, races, and religions, I experience great delight in the wonderful and beautiful diversity of our membership, both those with and without faith. The principle of unity in diversity holistically repudiates all notions of incommensurability and affirms harmony across all the dimensions of existence.

Harmony, therefore, to be real and effective, needs to be understood as this holistic concept that requires a genuinely holistic approach. Interfaith harmony cannot be actualized apart from cultural harmony, racial harmony, gender harmony, ideological harmony, community harmony, economic harmony, and world political harmony. None of these harmonies necessarily mean a lack of disagreement, conflict, or differences among the diverse peoples of Earth. But they all require an effective realization of unity in diversity that makes the diversities non-destructive simply because they are united within a deeper unity. That is why the WCPA strongly affirms the quest for interfaith harmony. As part of a holistic approach to harmony, it is part and parcel with the quest for world political harmony under the *Constitution for the Federation of Earth*. In the final analysis, the *Earth Constitution* could and should function as a universal framework — guiding the quest for interfaith harmony among human beings.

As I wrote earlier for *The ABC of Harmony*: the *Earth Constitution* provides a democratic and legal framework for the truth expressed by *the ABC of Harmony* that “people include all human beings from conception, irrespective of other qualities: gender, race, age, culture, religion, and so on.” The *Constitution* constitutes a global social contract that guarantees rights and responsibilities for all, simply as human beings, to ecological integrity, peace, social justice, and the fundamental elements of civilizational harmony. In this respect it provides a necessary condition for the actualization of the paradigm of harmonious civilization outlined in *the ABC of Harmony*.

### References:

*Constitution for the Federation of Earth*:

See Glen T. Martin, *Constitution for the Federation of Earth, with Historical Introduction, Commentary, and Conclusion*. Pamplin, VA: Institute for Economic Democracy Press, 2010.

The *Earth Constitution* can also be found on line at [www.wcpa.biz](http://www.wcpa.biz), [www.worldproblems.net](http://www.worldproblems.net), [www.earthfederation.info](http://www.earthfederation.info), [www.worldparliament-gov.org](http://www.worldparliament-gov.org) and [www.radford.edu/gmartin](http://www.radford.edu/gmartin).

Hick, John, *An Interpretation of Religion*, Second Edition. New York and London: Yale University Press, 2004, Chapter 17, “Soteriology and Religion.” John Hick is a Fellow at the Institute for Advanced Research in Arts and Social Sciences at the University of Birmingham, UK.

International Society for Intercultural Study and Research (ISISAR): [www.freewebs.com/isisar-worldpeacecongress/](http://www.freewebs.com/isisar-worldpeacecongress/).

Sri Aurobindo Movement: [www.sriurobindoashram.com/default.aspx](http://www.sriurobindoashram.com/default.aspx).

Universal Love and Brotherhood Association (ULBA): <http://ulbaintl.org/index.php>.

World Constitution and Parliament Association (WCPA): [www.wcpa.biz](http://www.wcpa.biz). See also [www.worldparliament-gov.org](http://www.worldparliament-gov.org).

World Union no longer appears as an active political organization. Today the name “World Union” refers to the journal on world unity as envisioned by Sri Aurobindo, published from Pondicherry, India.

**Dr. Glen T. Martin**, Multi-faith,

President, World Constitution and Parliament Assoc. ([www.wcpa.biz](http://www.wcpa.biz))

President, Institute on World Problems ([www.worldproblems.net](http://www.worldproblems.net))

Professor of Philosophy and Chair of Peace Studies at Radford University ([www.radford.edu/gmartin](http://www.radford.edu/gmartin))



Coauthor, *The ABC of Harmony*: [www.peacefromharmony.org/?cat=en\\_c&key=478](http://www.peacefromharmony.org/?cat=en_c&key=478)

Address: Radford, USA

Web: [www.peacefromharmony.org/?cat=en\\_c&key=428](http://www.peacefromharmony.org/?cat=en_c&key=428)

E-mail: [gmartin@RADFORD.EDU](mailto:gmartin@RADFORD.EDU)

04/01/13

Ammar Banni

## Multiculturalism of Interfaith Harmony

Although culture is the angular stone of national identity, geography as much as the history work to make the interfaith harmony a varied cultural mosaic. Subjected to these influences, interfaith harmony appears as a true cultural crossroads where various human types, religions and local civilizations meet. This interfaith extent of the human inheritance was enriched in its intercultural and multicultural aspects thanks to its voyages through planet. Interfaith harmony became a historical dream which inspires scientists and artists with spiced strong works which will become future thoughts of tolerance and conciliation of the people. Today, pragmatic economic globalization became the principal objective of the majority of nations. It created a one-dimensional cultural wave, which gave underprivileged a multicultural aspect between the people and religions and is limiting for interfaith harmony.

The culture of interfaith harmony and its multicultural historical dimensions can support the consciousness of the common humanitarian values in various cultures. Interfaith harmony has the new dimension of “cultural pluralism”, thanks to its various cultural and ethnic identities of the communities and nations. Cultural pluralism of interfaith harmony can carry out a dynamic balance and enrichment on the two levels: as its own faith as the world faith. It is essential as the culture of the democracy establishes an effective system of multiculturalism at the regional and world levels that is very important for interfaith harmony. Democracy together with multiculturalism of interfaith harmony invests into consciousness of the nations to be understood and be respected. This reduces the possibility of conflicts of cultures, religions and civilizations.

The multicultural dimension of the interfaith harmony promote a global harmonious culture which is able to prevent dangerous influence on the societies causing an uncertainty, a fear, a terror and hatred which lead to the conflicts and the wars. A global culture of multicultural interfaith harmony received in the beginning of 2012 a new powerful scientific and educational support: - a scientific world textbook *the ABC of Harmony* created in a multicultural team of 76 co-authors from 26 countries as part the Global Harmony Association: [www.peacefromharmony.org/?cat=en\\_c&key=478](http://www.peacefromharmony.org/?cat=en_c&key=478).

### **The Factors of Multiculturalism in Interfaith Harmony**

**1. The role of associations (NGOs).** The associations (NGOs) of civic society, especially the religious organizations, in various countries could be creating the new multicultural system of interfaith harmony on *the ABC of Harmony* base and adequate media and education. These associations can help in the collection of the various pluralist faith contributions of the knowledge and art in this broad system. Through these NGO's the multicultural system of interfaith harmony will provide development of social and religious harmony on both levels: national and world. This system will help to transform the industrial globalization to a harmonious and multicultural one.

**2. The role of media.** The media and telecommunications play an important part of interconnection between the individuals, nations and faiths in the process of multicultural and harmonious development. Discussion and learning in the media *the ABC of Harmony* can essentially expand, accelerate and spread its fundamental, harmonious and multicultural



knowledge. It is, in my opinion, the main purpose and meaning of media and telecommunications, especially Internet.

**3. The role of education.** With the emergence of *the ABC of Harmony*, which opened a new era of humanity – the Age of Harmonious Enlightenment ([www.peacefromharmony.org/?cat=en\\_c&key=511](http://www.peacefromharmony.org/?cat=en_c&key=511)), significantly changes the content, character and meaning of education. We have reviewed in detail this education in our article here: ([www.peacefromharmony.org/?cat=en\\_c&key=497](http://www.peacefromharmony.org/?cat=en_c&key=497)). It defines the educational programs of the multicultural interfaith harmony applied at national and international levels in syllabi of the schools and universities. It contains two principal moments:

(A) Direct contact with the other faiths by listening to points of view while managing to conclude an agreement a convention between the two members, with a mutual cultural and faith exchange. That avoids any kind of faith conflict, because an open and pluralist culture is always based on the interfaith and social values of the common *ABC of Harmony*.

(B) The museums and archives as the historical heritage treasury of cultural and harmonious references. This is another possible innovating aspect which supports the new system of multicultural interfaith harmony. This innovating democratic network can solve the universal research tasks of interfaith multicultural and harmonious processes.

The scientific *ABC of Harmony* and based on it a global harmonious education create a new, conscious and scientific, multicultural interfaith harmony system that meets the requirements of the 21<sup>st</sup> century and harmonious civilization, born at its beginning.

**Ammar Banni**, Muslim faith,  
Professor of education,  
Poet & Writer. GHA Honorary Member since 2007. GHA Honorary Poet of Peace from Harmony for 2008. Famous Algerian and Moslem peace lover.  
Coauthor, *The ABC of Harmony*: [www.peacefromharmony.org/?cat=en\\_c&key=478](http://www.peacefromharmony.org/?cat=en_c&key=478)  
**Address:** Guemar, Algeria  
**Web:** [www.peacefromharmony.org/?cat=en\\_c&key=288](http://www.peacefromharmony.org/?cat=en_c&key=288)  
**E-mail:** [ammarbanni@yahoo.fr](mailto:ammarbanni@yahoo.fr)  
16/01/13

Uraz Baimuratov

## Islamic Banking as Institution of World Interfaith Harmony and Harmonization of Consciousness

The trend existing in the world economy of the increase in the Islamic finances and institutions has become generally known. It is written by everybody, who touches on that subject. At the same time, the existing experience in the Islamic financing, as any complex social phenomenon, requires careful understanding, the identification of problems thereof and the determination of ways of the further development. But, first of all, about the difference of opinions and ambiguous judgments.

The opponents to the Islamic finance system can be divided into two groups. The criticism against the Islamic finances is often heard both from the right and from the left. Many adepts of the Islam complain that the finances are referred to as the Islamic ones, however, in their opinion, the Shariat requirements are not complied with, and it is assumed that there can be an analogy of them with the traditional ones according to a number of positions (credit proceeds, excessive mortgage prices, high bonuses of bankers etc.).

The opponents from the left would like to liberalize the Islamic financial system so as to bring it together as close as possible with the traditional one, and to lift restrictions of the Islamic ethics as much as possible. Especially often attempts are made to muddy the waters where the question is about the Islamic percent-free credits.

From our point of view, the criticism from the right is justified in that the practice of the Islamic financing is clearly not perfect yet. It has quite a few shortcomings related to the human factor. The total creative potential of the true Islam has not been full unlocked therein, which, by the way, is inconsistent with fanaticism, radicalism, terrorism, and percentmania. Any money gains on any borrowed funds are prohibited within the Shariat. On the other hand, no credits without income (percent) are applied as a system in the banking practice, to the exclusion of several countries, at least in Kazakhstan. It's paradoxical but it's a fact.

Being aware of the problems and the necessity for the improvement of the Islamic finances, one should hardly refuse the name itself. Firstly, it has already taken root in the world financial system, and, secondly, its fundamental principles are taken from the Shariat, which history includes almost fourteen centuries. The priority of the Islamic economic model over the traditional one is indisputable both according to the time of development and to the level of excellence of the same. Thirdly, analyzing the existing experience, one should look for ways, mechanisms and instruments of its improvement and the bringing it fully into line with the principles of the true Islam. That would be an affirmative approach.

Following such aim, let's make an effort to answer some questions arising out of the current reality. Those countries, in which the Islamic economic model has not functioned yet, and which have fallen behind those ones where it has been already applying, have one advantage – there is a possibility to critically study the way of those, who go ahead and to learn a lesson for themselves.

The Islamic financing model, in our opinion, may be improved in several aspects. And the principles being at the root thereof must remain inviolable. They include a great potential of the harmonious growth of economy and the whole society. They have such things as any other principles do not include, for example, «zakat», non-percent bearing credits.

First of all, meeting the Shariat requirements for the inadmissibility of any increment through any federation, it is advisable to introduce into practice of the Islamic banking the granting of credits without revenue (percent). It is its great advantage, which does not contradict to the Shariat, on the contrary, it is encouraged, and which has not been actually used in our enlightened world so far. Here it is very important to repeat no mistake of the traditional banking consisting in the blowing of credit-percent «bubbles», in the excessiveness, which leads to the high credit-percent dependency («on the needle»). The percent bearing credits generate financial and economic crises, aggravate social injustice in the society, and constitute a threat of destruction of the civilization. Things should be in a different way in the Islamic banking. How?

It is clear that any Islamic bank won't be able even to survive in the present-day market economy, not to mention any prosperity, if it is only (!) engaged in any unprofitable crediting. Such extremity like any other one contradicts to the very essence of the true Islam. To be moderate in every thing – this wonderful idea about the Harmony passes through the whole ideology of the Islam. On this basis, one can arrive at the idea of combination of two activity bases in the Islamic banking – credit (unprofitable) and investment (with formation, of course, of revenue) ones and, therefore, - at the so-called «package (complete) financing». All banking services and products should be, where possible, be provided to the client in one set, in the unified complex, and in one package. Market and nonmarket mechanisms can be combined there through that is typical of the mixed economy, and one can overcome clashes of percents between the Islamic bank and the borrowers that, apparently, frighten many persons. The way out of it is combination of, it would seem, the incompatible, in that case, in the package financing. The higher the efficiency of investment projects and the more the number thereof, the more the bank will be able to afford the issue of unprofitable credits, and the more possibilities can be provided for the package financing, instead of the specific segmental approach to the forms of financing. It is so possible to create a synergy in bank activity, lack of that while complicates application of interest-free crediting.

The availability of unprofitable credits in the bank package of finances enhances their attractiveness for companies of the real sector. Such loans have an important feature; they are

like an “ambulance”, at any moment they may be provided to customers for a variety of routine tasks. Therefore, they should be returned in time which is important to meet growing demand for relatively small deposits. This contradiction between supply and demand can be eliminated by providing a large turnover of money. The traditional financial institutions are not engaged in such credits and cannot, by definition, be engaged in them. So one can expect the growth in demand for the Islamic finances. As a consequence, in search of economic benefits, a flow of clients (companies together with depositors) and money flows from the traditional banking to the Islamic one. Such win in the competitive struggle with the time may become quite logical not only from the economic point of view, but in moral respect too. Here the logic is that under the current conditions, the economic benefits still remain the main ones for many people. As we think, in the course of time the situation will change towards the spirituality, and the role of money will become the other. And hundreds of millions И сотни миллионов, if not milliards of the Moslems and the Non-Moslems will, to the best of our belief, vote in favour of the Islamic economy and finances, and the world economy will undergo changes to the Harmony. In that way the percentmania may bring itself to destruction! It is so possible to create a synergy in bank activity, lack of that while complicates application of interest-free crediting.

The reality of the current world economy has become the prevalence of two basically different economic models, in particular, different finances – traditional and alternative ones referred to as the Islamic ones. By the way, the similar concept of the reasonable usage of money is in the Judaism, the Christianity, and the Islam developed historically much earlier than the so-called traditional system. However, we take interest in the essence of different financial systems.

It is an everyday occurrence to compare them purely according to financial and economic parameters and their competitiveness. The established truth is ignored that the models of economy and finances comparable due to the spiritual basis are absolutely disparate. The former, the traditional models, have actually no spiritual basis (it was degraded long ago); the latter, the alternative ones, on the contrary, have a firm basis. Let’s try to determine the difference between them in the terms of economics.

If to consider all the economic models existing in the world (Anglo-Saxon, Continental, Scandinavian, South-European, Japanese, Chinese and other ones) and compare them in terms of social justice and stability of economy, then it appears that all the said models cannot thoroughly ensure the harmonic development of the society and the economy. The basic disharmony between the material and the spiritual is peculiar to them more or less, and the former will prevail over the latter. It shows oneself as percentmania. With what is it fraught to the economy and the society? Its negative consequences can be reduced to the following:

- Mania for percent earnings sometimes clears the way for a life of joy (why to work if one can live due to the dividends?). Any weakening of labour activity of the population while its dividends increase, will certainly affect the decline in production goods and services. We can see that from the crises of a number of countries in the developed area. That was well-known as early as in the times of the ancient world.

- The percent rates enhance motivation of bankers to the increase of credits, sometimes with high risks, since their bonuses depend on such economic behavior of employees. The advertising often invites clients to the banks to obtain quick credits. The mortgage crisis in the USA demonstrated «amenities» of the percentmania, basing on the economic laws of the increase in needs, the demand and supply, and the profit maximization, the real estate market participants inflated volumes of credits, percent on them, and prices for housing. Failing the inner restriction in the consciousness of people, they blew up a «housing bubble», which initiated the global financial crisis. The Islamic bank in the mortgage market can operate more humanely, it grants incomeless credits, and ensures a reasonable level of prices and favourable conditions of reimbursement of credits.

- Deposits with percent ensuring easy unearned income to the depositors are able to enhance a taste of persons for money and material benefits, and to encourage egoism while simultaneously reducing the sense of collectivism. Consequences of such deformation of the

consciousness of a person may be often drastic for the society. One of them – a decrease in the role of family and marriage, and decline of birth. Almost all the developed countries of the world suffer the ageing and the net reduction of the number of their nations. There is depopulation without wars and epidemics. Already this fact must make all of us think of the negative essence of the percentmania.

The Islamic economic model is of special importance. It is a highway to the harmony of the society and the economy. The Islamic economic principles if used in full may to a large extent eliminate social injustice, which inevitable under any other economic models. The Islamic economic model harmonizes moderate rates of economic growth strengthening social justice both due to the real sector of economy and the GDP redistribution.

Movement towards the Harmony implies such arrangement for the life of the society, which must be based on the following five fundamental principles. They are required by the commandments of the Supreme Being, and following them one can choose the right vector of development. They are as follows:

- Moderation in needs and desires of individuals;
- Justice in economic relations;
- Benevolence of the rich people to the poor ones;
- Balance of interests between the individuals and the society;
- Private ownership.

In the modernization of the national economic system with the switch to the harmonious social economy of a new type, it is possible to use forms of the Islamic financial banking in parallel with the traditional western model.

Functioning of the financial system subject to the combination of the two models does not contradict to the experience of those countries, in which there exists the similar bipolarity. For example, there are all prerequisites to develop a purely Islamic model of economy in mono-confessional Arab states. Though in such form, it is used just in Pakistan and Sudan so far. Other countries go along the way of combing different models in one or another proportion and subject to religious peculiarities of their peoples. However, a highly harmonious economy therein is practically difficult to develop owing to the inhomogeneity of the confessional make-up of the population. But in my opinion, such difficulty can be overcome in the future. Why?

Quite a number of values coincide in various religions. It is of crucial importance for the economy that the business honesty, the justice in economic relations are peculiar to any religion. Secondly, the current financial markets (credit, stock and currency ones) have become the ones with high risks subject to instabilities and crises that undermine credibility of the population to the traditional financial instruments. Clients of banking systems in many countries need new alternative services. It's not for nothing that the population takes more interest in the Islamic banking, shares, leasing and insurance.

The experience of different countries shows that not only the Moslems but also votaries of other religious faiths prefer Islamic financial institutions. Clients are served by the Islamic banks irrespective of their religious convictions in England, Germany, France, Malaysia and some other states. They form their own deposit basis by enhancing confidence them, their stability and the population interest in qualitative financial services.

The business position in relation to the Islamic banking and finances, and the whole economy is of fundamental importance. The companies are much interested rather in investments than in credits bearing percents. Integration with the production interests – the key factor of development of the Islamic economic system established on a firm spiritual and moral basis. All the other economic models have no such unique feature. At its core, the Islamic economy is associated with a high level of mutual confidence between the investors, the banks and the other financial institutions and companies. No signs of suspiciousness, foul play, and corruption are acceptable to it in its relations with people. Everything should be clear, honest, just and transparently. Just these qualities should consolidate all healthy forces of the society in its confrontation with any carriers of negative developments in the society and the economy. The

institutions of the civil society and, certainly, the authorities other than business structures should be on the side of adherents of the Islamic principles in the economy and finances. In the long run, the support of the population, which votes with its money for Islamic institutions, and the just assessment of its values, will be of crucial importance.

The strengthening of confidence and partnership relations between the business and the banks will create the possibilities for the development of percent-free crediting of the real economy, the expansion in competitiveness of companies, and the reduction of prices for goods and services. And this will lay the foundation of respect from the Non-Moslem world to the values of the Islamic ideology, for the true perception of the essence of the same, and the removal of the unjustified phobia in relation to the Islam. Any ground for demonstration of radicalism and terror will disappear. Partnership relations between the West and the East will be established. Such is the very core of the Islamic finances and economy, and their invaluable importance for the present-day world.

According to the Shariat, percents on credits, derivative securities, and sales of currency shall not be applied. They are beyond the law. In the society with the Moslem and Non-Moslem population, the national economic system is formed by the combination of the two models – the Islamic and traditional ones. And it acquires features of the mixed economy. Along with the purely commodity markets, the percent-free credit market and the stock market without any speculative constituent operate therein in the modified form. There should be no currency market as such, but evidently there may be exchange points with fixed exchange rates. To put it otherwise, in the financial sector, the category «price» is applied rather restrictedly as money is not good according to the Shariat.

There are two first principles in the world view of the Orientals: individualism and collectivism. As related to any individual, their correlation develops in its own way but the presence of both of them together presents a regularity under the influence of the spirituality influence, the mentality, and the social environment.

The ambivalent nature of the world view of a person shows itself rather in a peculiar kind in the financial sphere, particularly, in the Islamic finances. Thus, financial relations are formed under the influence of the spirituality as broadly defined, in particular, of the religion. In the Islamic finances, money is not goods and they are not subject to any sales, credits are granted without any fees (percents), no speculative cycle of money, and use thereof for any prohibited purposes (alcohol, tobacco smoking, drugs, gambling, entertainments) are allowed. Money is used both for the sake of individuals' own interests and for the purposes of assistance or support of their relatives as well as poor people. To that effect, a compulsory tax “zakat” shall be charged. The altruism of the Moslem does not become exhausted due to it. He can provide business with his idle cash to one extent or another as a credit without fees (percent).

Motivation of savings is required by the Islam, in our opinion, where the revenue of an individual exceeds his reasonable needs, his idle cash should not be accumulated without movement in the «domestic bank». on the contrary, the idle cash should be involved in the turnover. This circumstance makes the individual apply to a bank for the opening of a bank account. That is why the client, due to his dual purposes (income for himself and for the borrowera) should, as we think, open the following two bank accounts: investment and credit accounts.

The economic system based on the spiritual and moral values, is able in the best way to combine a stable economic growth with social justice, to cease and reverse the existing excessive polarization of the society in relation to income, where the rich grow richer and the poor grow poorer. Let's pay attention, for example, to the state of Oman where there is no poverty.

As regards the social picture in the countries of the developed area, in particular, within the Eurozone and the USA, the social polarization is not decreasing but increasing during the years of the present-day crisis. By that reason, in quite a number of the developed countries, there occur protests of the population against the existing economic system where money moves

from salaries to profits of the owners and top managers, from the average and poor layers – to the rich and the super-rich people, from satisfaction of spiritual needs to material benefits.

In our opinion, at present there are some speculations in relation to percent -free credits. It is stated that mentioning no percent, the Islamic banks get an increase in money. Though the economic content of the notions “bank percent” and “separation of risks and income (loss)” is different, they are perceived by the everyday awareness of people as the same things. In that way, the competitors of the Islamic banking use their efforts to distort the essence and to stop a flow of clients to the Islamic banks. Therefore, in full conformity with the Shariat and from the purely pragmatic point of view, it is expedient to apply the notion “Islamic percent-free credits”. Short-term (until one year) credits without fees (percent) could be referred thereto. But long-term credits differ from the short-term ones and at its core coincide with the notion «investments» bringing commercial earnings from the separation of risks and profits. They should, therefore, be considered as investments. There are opponents, who deny the very name of Islamic finances referring to shortcomings of practices thereof, problems in business organization, insufficient qualification of the personnel thereof and others. But all this gives no ground for the refusal from the established term «throwing the baby out with the bath water». It is easier to wave away from the problems available than to be busy with their solution. We'd like that the constructivism could prevail the nihilism.

Since the Islamic banks bear a function of gratuitous support of those, who need idle cash of their clients (entrepreneurs), in addition to the commercial function, they cannot have partnership relations with them. That implies the joint accumulation of investment and credit resources both of depositors/investors and borrowers, and the provision of various banking services and products in the single package. Their important feature is that limited resources are aimed at the satisfaction of reasonable needs of persons and they are not diverted for various pernicious habits of people. Here the orientation of the Islamic finances towards the creation of the good and the exclusion of the evil is meant.

The Islamic finances based on the common values of the mankind are attractive to the total population irrespective of confessions and nationalities therein. Honesty, readiness for mutual assistance and support, justice and business transparency are the key criteria for an access thereto.

A modified model of the Islamic financing is possible, which will enable to increase the competitiveness of Islamic (short-term or long-term) investments as compared with the traditional ones, and it is advisable to combine them with short-term unprofitable (percent-free) credits. The single banking package of financing of the real sector of economy and the social sphere may be formed from them. In the said package, forms of financing of companies and their projects may change subject to the needs of the fund receiver. Still the unprofitable credit remains an invariable constituent. Its share in the package of financial services and products, in our opinion, should be not less than 20% of investments. Thus, one may and must combine desires (interests) of the depositor/investor and the recipient of resources as they both have the same ambivalent nature – of an egoist and an altruist simultaneously. The essence of the traditional finances unilaterally oriented towards the satisfaction of selfish and material aspirations, and money fetishization, does not meet the said feature of a person wherever he is and whichever confession he adheres to. But the Islamic finances are more harmonious and humanistic.

The economic interest of the said bank is ensured by combining finances with unprofitable (percent-free) credits granted in various forms in the single package. In case of an effective usage of funds, revenue from the former should overlap the lack of such from the latter. So, any artificial connection of the notions «credits» and «revenue» is not required. Credits within the Shariat are encouraged, but any percents is rejected. According to the Shariat, they are incompatible wherein the uniqueness of the Islamic finances based on the commandments of the Supreme Being consists. One can only regret that the said possibility of the Islamic finances is not used!

They, especially percent-free credits, contain germs of a new economy and a new direction in thinking. It's a benefit that the world economy has still an opportunity to successfully develop along the said way of the good!

It is possible to regret only that this opportunity isn't used fully in Islamic finance. They, especially in the interest-free credit, contain sprouts new, harmonious, style of economic thinking and new, harmonious economy, as material base of world interfaith harmony. Studying and use of the Alphabet of Harmony ([www.peacefromharmony.org/?cat=ru\\_c&key=504](http://www.peacefromharmony.org/?cat=ru_c&key=504)) as the population, believers, and financiers, with banking will provide conscious transformation of this opportunity into reality of world harmonious fair economy and the world interfaith harmony based on it.

**Uraz Baimuratov**, Muslim faith,  
GHA Ambassador of Peace and Disarmament from Harmony,  
Academician of the National Academy of Sciences of the Republic of Kazakhstan,  
Doctor of Economics, Professor, Honored Worker of Science of Kazakhstan,  
Director of the Institute of Finance & Banking Management,  
Author of the book: "*Harmony of Society and Economy: World Paradigm*" (2010)  
**Address:** Almaty, Kazakhstan  
**Web:** [www.peacefromharmony.org/?cat=ru\\_c&key=561](http://www.peacefromharmony.org/?cat=ru_c&key=561)  
**E-mail:** [uraz.baimuratov@gmail.com](mailto:uraz.baimuratov@gmail.com)  
23/01/13

Manijeh Navidnia

### Interfaith Harmony and Societal Security

Religion is one of the bases of social life, dating back to the life history. In all human life periods religion has a key role in education, training, assessment, solidarity, comfort, politics, day life and so on. Religious with its beliefs, laws, regulations and rituals affects on thoughts, emotions and behaviors and determine a specific lifestyle for its followers. Regarding the importance of religion, it can be concluded that religion is one of the main factors for realizing the goals of human society. In this regard, the international community who wants to organize the global citizen can not ignore religion. But divine religions and ancient rituals require the integration and harmony between themselves to bring constant multilateral interactions to the international community. Each religion goes to its own way and ignores intermixing and tolerance with other religions, the international community would loss one of the major channels for interaction and connection between people. Hence, the interaction between the religions is on of the necessity of today world.

Acceptance of pluralism, recognition of different religions, respect for each other's rituals and practices, respect for different rules and, taking into account the concerns of other religions, knowing the necessity of joint activity, considering the importance of communication with other religions, and emphasizing the similarities rather than the differences, are some issues that religions must achieve with interaction with each other. A ground without any biases or prejudice must be provided to realize an interreligious dialogue and discussion atmosphere to achieve such results; an atmosphere that represents religions intermixing as different flowers of human garden and shows the beauty of life in perception of different colors. To achieve such positive interaction between the religions, all the hazards and risks that may hinder the interaction and intermixing of religion, must be minimized or at least be controlled. The dangers of religions to each other can be divided into five general categories:



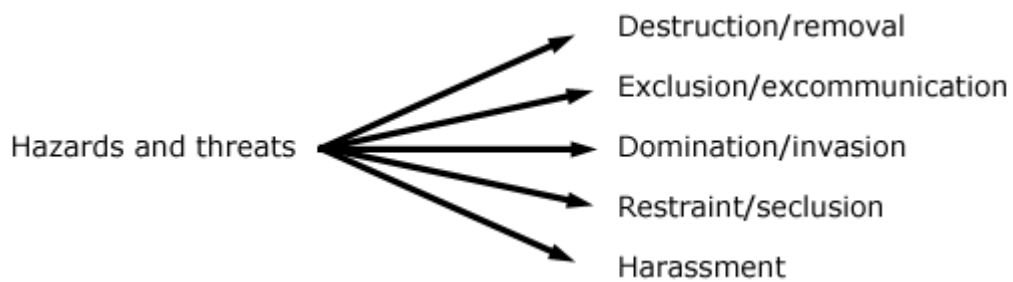

It is clear that one of the mechanisms to deal with risks and threats and to prevent their loss is "societal security". Societal Security looks for to safe conditions, away from any worries and fears for all social groups to be able to continue their life and work during communication and interaction with other groups. In other words, Societal Security is to provide the conditions in which dependence and connection of social groups doesn't make problems to protect and preserve their being and identity. Regarding the definition of Social Security, the societal security is multifaceted and consists of a combination of different security needs. In relation to risks mentioned before, we can notice the following security measures:

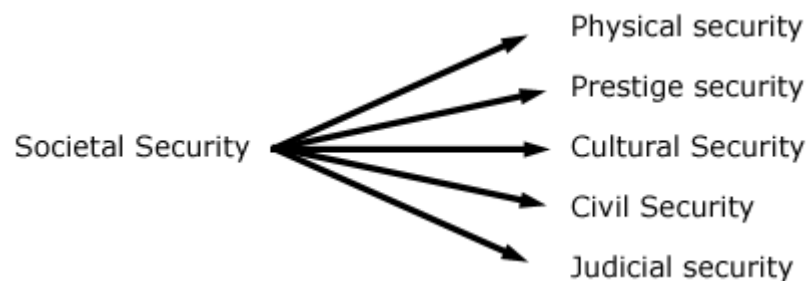

Physical security is to eliminate threats to individuals' lives. Hence, life security can combat all threats aimed to "destruction and destroy" followers or leaders of religion and can ensure their survival.

Prestige security is responsible for confronting circumstances that led to weakening the honor and dignity of individuals. So, the risk of "exclusion and excommunication" that is one of the ways to not recognize and not accept, will be controlled by the prestige security.

Cultural security tries to ensure conditions in which cultural beliefs and behaviors could promote and applied for minorities and majorities. Cultural security prevents "domination and invasion" of a belief or ideology and gives social opportunities to all groups. Preservation and protection of ceremony and ritual is one of its duties.

Civil security conflicts with any restrictions and censorship and deliver civil liberties such as freedom of speech, press, books and news. Thus, civil security is a major obstacle to those who seek to limit or isolate a religion.

Judicial security guarantees natural rights and prevents harassing behavior. This aspect of security ensures believer that in any extortion and irritation, people rights can be investigated by judicial laws.

Thus, addressing the question "What is the relationship between religious relations and societal security?" we can answer that social security in general and its aspects in specific provide a safe atmosphere to conflict the threats to religions. Societal security provides a healthy environment for interaction by elimination of risks, risk control and management and threats prevention. A ground that removes the worries from believers' heart, assures them that there is no obstacle to promote religious beliefs. Rites and rituals are allowed and possible. There is no risk for the influx of certain ideologies and beliefs. There is no threat for religious thought exchange. There is no heavy penalty for religious belief and religious orders can fulfill without any fear.

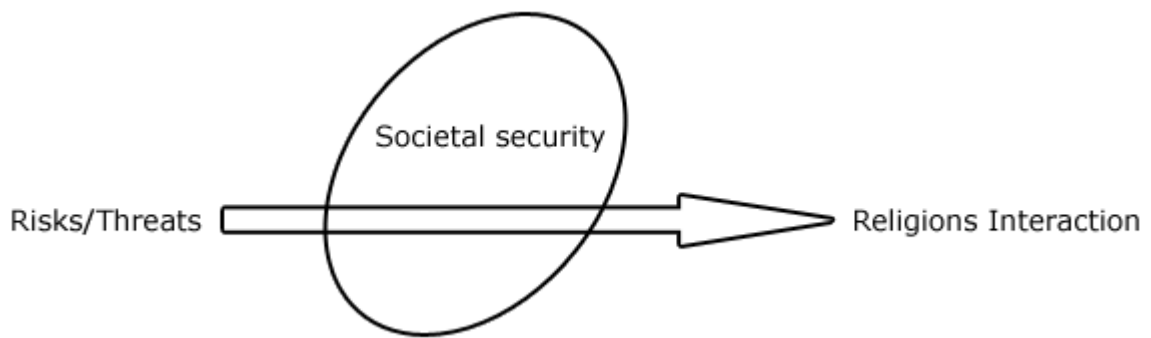

Therefore, the international community's concern that differences in religious beliefs can create an obstacle to believers' interactions and relations will be changed by the realization of societal security: diversity and multiplicity of religions has no problem for believers' coexistence unless there is not enough security to prevent interaction hazards. In other words, Societal Security adopts the same approach to all religious groups and recognizes the security as a natural right for everyone and by providing safe situations, decrease fear and insecurity and make emotional bond between groups.

Thus, Societal Security can promise realization of multiple interactions and relationships between religions and gather religions in a safe environment together regarding their common concerns and interests such as saving and salvation of man.

For societal security and interfaith harmony very important is global harmonious education through *the ABC of Harmony* ([www.peacefromharmony.org/?cat=en\\_c&key=478](http://www.peacefromharmony.org/?cat=en_c&key=478)), forming a harmonious consciousness of all people, including believers. This consciousness is the most solid foundation of societal security, interfaith harmony and world peace.

**Manijeh Navidnia**; PhD; Moslem faith,

Assistant Professor in Sociology; Faculty member at Azad University, Garmsar Branch. She was born in Tehran, Iran, 1964. Specific researches are sociology of security particularly concerning Societal Security. GHA Board Vice-President.

Coauthor, *The ABC of Harmony*: [www.peacefromharmony.org/?cat=en\\_c&key=478](http://www.peacefromharmony.org/?cat=en_c&key=478).

**Address:** Sociology Department of Azad University, Daneshjoo Blvd. Garmsar, Iran – P.O Box: 3581631167

**Web:** [www.SocietalSecurity.com](http://www.SocietalSecurity.com)

**E-mail:** [navidnia@hotmail.com](mailto:navidnia@hotmail.com), [navidnia@societalsecurity.com](mailto:navidnia@societalsecurity.com)

22/01/13

Steve V. Rajan

Inner Divine Meditation for Interfaith Harmony

(Published: *The ABC of Harmony*, 2012, p. 161-162)

Our whole life depends on and evolves around our individuality. When our thoughts are focused on ourselves and the environment, we always have the feeling that "we exist". When we hold this book, we have the feelings that this book exists. Now let us ask ourselves "what is that existence" and how do we exist?

Everything we experience in life through the five or sixth senses, packaged by its name and form, produces in us a feeling of existence. The human body and the entire creation is only a primordial existence of energy packets or quantas vibrating with individual names and forms, shaped by atoms and molecules and forces of nature. In reality, we are all bubbles and waves of vibration within a limitation of time and space. Birth, death, concept of peace from harmony is nothing but bubbles of waves of vibrations that exist on different planes of existence in the descending order of: The Soul Plane, Mental Plane, Astral Plane and finally the Physical Plane.

Everything ages and changes are in all the planes of existence. The concept of "peace from/through harmony" first existed in the soul plane as vibrating energy. The vibration became denser as electrons and protons became atoms through forces of attraction and later evolved into molecules and then into elements of nature – Earth, Water, Fire, Wind and Space. The human body is a different conduit to experience the elements of nature. The brain receives the sensations of elements of nature through the windows of the sense organs. The mind in the state of confusion could not discriminate and receives all sensations to be stored in the conscious, sub-conscious and unconscious part of the "mind" as sensations or engrams.

When a child is born and first experiences light through its optic nerves, it does not see anything. Nevertheless the child's mind becomes one with the light. When the auditory nerve first experiences sound, the child's mind becomes one with the sensation of sound. Minute-in minute-out, the child begins to build its own repertoires of sensations, engrams, experiences of its "existence" as memories. The memories that agree with our existence, we call them pleasant and memories that disagree, we call them painful and nightmare.

The stored memories can affect all our metabolic changes, infinitesimally at the energy packets level resulting in the manifestation of conditions of ease or dis-ease in the physical frame of human physiology.

The human birth is said to be the ultimate masterpiece of creation. Why then is there chaos, diseases, destructions and confusion? What is the purpose of the human birth? Why are we born? Where is our destiny? Where are we moving to from here?

How can we enjoy the streams of joy and bliss vibration outside the inside of our consciousness? Our existence is determined by the number of breaths. Our destiny is determined by the number of breaths. We do not take a breath but RECEIVE a breath that takes us into the climax of life. The external stress of living has pigeon-holed us into a bubble of tragic living. How do we wake up from this dreamless state of sleep?

At what point of living do we experience our individuality in life? At what point in life do we experience the bliss of human life – that unbroken existence. Are we awake, or living in a dream state or existing in a dreamless sleep state? The work we have joined hand to do on the platform of "Peace From Harmony" on the outside, can it remain unaffected and untangled by the internal turmoil of our existence?

As we receive another breath now, we continue to exist in a vibratory state. How do we exist in relation to ourselves? Can we transcend the three states of existence – Waking, Dream and Dreamless Sleep – to realize the true essence of our existence?

Perhaps this exercise 30 minutes daily might help to experience the bliss within together with deep inner "Peace FROM Divine Harmony". In prayers, we speak to the Divine. In meditation, the Divine speaks to us.

**The Inner Reality of Peace Through Harmony Contemplation Exercise:**

- a. Sit in a comfortable position, close your eyes and focus on your breath for 3 minutes.
- b. Now say silently "God purifies my life, mentally, physically, emotionally and spiritually".
- c. Then wait for the echo coming from the Divine Source. Be a silent observer of the images of light and sound inside your head. Don't anticipate. Just Observe.
- d. Then say silently "God purifies my life, mentally, physically, emotionally and spiritually". Focus on the echoes.
- e. Then wait for the echoes coming from the Divine Source. Be a silent observer of the images of light and sound inside your head. Experience the flashes of happiness and state of peace from Divine harmony.

This experience is very important for the conscious building of peace from harmony in the world, for harmonious civilization and for harmonious education.

Inner Divine meditation (talking with God) is essential for inter-faith harmony, bringing together people of different religions, making them more understandable to each other. But understanding between them at the level of intuitive meditation, all its importance, is not enough

as outside of it begin deep divisions between believers in understanding the social and religious harmony. Overcoming them is possible only at the level of scientific harmonious education based on the scientific *ABC of Harmony*: [www.peacefromharmony.org/?cat=ru\\_c&key=504](http://www.peacefromharmony.org/?cat=ru_c&key=504)

**Steve Varatha Rajan**, PhD; Muslim faith,  
Founder and Chairman of Borneo Open International University, USA ([www.borneo-edu.us](http://www.borneo-edu.us));  
IAEWP Vice President for Strategy as well as GHA's Representative for Asia Pacific. In 2008,  
he had successfully organized the 18<sup>th</sup> IAEWP World Peace Congress in Malaysia. GHA Vice-  
President.

**Address:** Malaysia

Coauthor, *The ABC of Harmony*: [www.peacefromharmony.org/?cat=en\\_c&key=478](http://www.peacefromharmony.org/?cat=en_c&key=478).

**Web:** [www.malaysian-iaewp.org](http://www.malaysian-iaewp.org), [www.welcome2peace.org](http://www.welcome2peace.org)

**E-mail:** [steve\\_rajana@yahoo.com](mailto:steve_rajana@yahoo.com)

24/01/13

Celia Altschuler

### Interfaith Meeting through Love and Education

Religious beings can meet through the greatness of human love and solid education. Love is the strongest and most peaceful word on Planet Earth. It heals our human nature. It brings closure to our differences including these: racial, gender, cultural or religious. Are we ready to learn to love? Are we ready to teach its many ways of expression and manifest it through our lives? This is a question that leads us to meet the core of our existence in this world. We pass briefly though this life, yet we have lost touch with the essential beauty of our main purpose and need for unity through love.

If we close our eyes for a minute and open them to an aware state of our mind, recognizing that we need to be part of our humanity and our Earth and its needs, our life and attitude will change. But we need to meet our challenge and reach that Oasis to mankind called Love for all there is. And I might add that this kind of love requires respect and service to all that surrounds us in this Planet, including its Nature. Love admits no separation. It is “the marriage of true minds”, like William Shakespeare says in his sonnet number 116.

I now remember a dear friend in Valencia who made a comment on how mothers love their children and said “You see my fingers - they are all different, so are my children with different personalities, behaviors and needs, and yet I love them all the same and try every day to fulfill their spiritual, emotional and material needs. It does not matter if they respond differently. It will continue to be a challenge of great love expression.”

Love cannot gear its way through the path of Unity if it is not guided by compassion and respect. Unfortunately we have lost compassion for others. We are too immersed in our microcosms, unwilling to return to collective unity. We walk in fear, greed, and loneliness as we have established a micro world of our own, without time for others. Our ego has made us self centered prisoners not willing to unchain our hearts from it. A free open heart can enrich its soul by creating change and returning to a compassionate service to family, community and country. It is to our reach. It just requires humility, and willingness.

We have a great need to respect life as it is. This is a healing medicine for humanity. Our surroundings in our Planet teach us a lesson of life and its development on Earth. Beauty surrounds us and we must be aware of it and feel gratitude for its greatness. We must realize that we are part of that beauty and respect its noble nature while coexisting with it. Our spiritual essence should lead our souls to look at nature and life through the eyes of Love and respect for every living being on this Planet. The spiritual essence of interfaith harmony is also Love.

Education is the key to freedom for humanity. It opens our eyes to a clear horizon and a better way of living. It suits us with the tools that we need to survive and sustain life in our

Planet. But we need both Spiritual Education based on basic principles of good living and love, and education based on human reason and scientific knowledge of harmony. We need to know so we do not make the same mistakes over and over.

We need to open education to reach every end of the Earth, an equal human right for all, FREE at the reach of every human being. We must create an effort to create strong media education for the world and adult generations. It is happening but we still must continue an effort on reaching a great amount of audience with high quality educational programs. In many of our countries there is still need to bring computer education and machines to the less fortunate young population of public schools, to the elders in homes and to the children in hospitals. Our libraries must be fully equipped with materials and ready to have an agenda for speakers, educators that can reach the public audience. The museums must be another mean to education by offering talks on art exhibits, workshops for the community on how to appreciate art, and plastic arts for the adult community or youth. We can not achieve interfaith harmony without all of this.

Poetry events must meet in the local plazas, with an open microphone as we meet in Mayagüez “Plaza de Colon” in Puerto Rico every last Friday of the month at 7:00pm. This cultural event is open to the general audience and there is a book to sign in order for each person who will read two poems. It is a friendly cultural gathering, enhanced by two musicians that usually accompany us. Plaza visitors and tourists are also attracted to join the event, which is sponsored by the Municipality and its Major José Guillermo Rodríguez. Poets, artists, scientists, engineers, agronomists and students, community members, and tourists are there for the Poetry evening. Poetry is very important for interfaith harmony and meetings.

In education, Science and Arts must meet to bear a renaissance human spirit which will be at ease with both, while bringing the educated to a completion and balance. We must respect science for bringing us to scientific reason and knowledge and keeping us away from nurturing false premises, but we also must respect the arts for the capability to create and reach sensibility to a spiritual understanding that all humans need. Creativity brings us to lift our spirits in order to touch our essence. Interfaith harmony cannot be without the unity of science and art, reason and intuition.

Family education is also essential and should reinforce solid school education. Parents must receive community education from parent school workshops and community library meetings, from media education for parents, and education through local community cultural activities. This will reinforce home education for their children that will support the school curriculum for teaching values for Peace and Global Harmony as proposed in *the ABC of Harmony* ([www.peacefromharmony.org/?cat=en\\_c&key=478](http://www.peacefromharmony.org/?cat=en_c&key=478)). This and similar global scientific textbooks of harmony constitute the necessary spiritual base for common interfaith harmonious education.

Education then will nurture both the Spirit and the mind. It will bring the balance we all need. No doubt that to reach Peace and Harmony we must re-structure our curricula for an Education based on the principles of human values for Peace and Harmony as *the ABC of Global Harmony* expresses.

In my country Puerto Rico, education is affected by political elections every four years. When a new governor is elected, radical changes are made through management and changes in policies and personnel are made. As an educator I believe education must not be part of a political issue. It must be detached from politics for the progress and sanity of all. It must have only one challenge to create a harmonious, peaceful, educated, loving human being who can contribute with a positive participation in this world and find the own way to interfaith harmony.

*The ABC of Harmony* and globalization brings hope by offering a reasonable proposal to all humans. We must make a leap and reach a broader way of understanding our present needs. We need to work towards unity and a collective conscious interfaith harmony in order to solve our problems before it is too late. The first problem is interfaith spiritual harmony, beyond which there cannot be world peace and love. It is now our responsibility for all humanity, every living thing in nature and the Earth itself. Education for global Peace from Harmony is the way to go

for a positive healing change. Love is equal to extending and embracing all the human beings in the world as our planetary family. When we speak Love, Peace finds its way from harmony for all, including religions.

**Celia Altschuler**, Catholic.  
Acting President, GHA-LAC,  
GHA Ambassador for Peace and Disarmament from Harmony in LAC,  
Artist, Poet, Translator,  
French Professor, Media Producer.  
**Address:** Parguera, Puerto Rico  
**Phone:** 787-462-1031  
**E-mail:** [psoleil5@yahoo.com](mailto:psoleil5@yahoo.com)  
16/02/13

Abbas Panakkal

International Seminar on Interfaith Harmony & Tolerance  
February 26-28, 2013, Malaysia

[www.peacefromharmony.org/docs/Malaysia\\_Interfaith\\_Harmony\\_Seminar-16-02-13.pdf](http://www.peacefromharmony.org/docs/Malaysia_Interfaith_Harmony_Seminar-16-02-13.pdf)

The more the person recognizes and respects traits and talents within himself or herself, the more the person is likely to understand and admire the rest of the humanity. In effect this means just admiring others' religions and tolerating their beliefs - that is the unique message of the International Seminar on Interfaith Harmony and Tolerance.

Each of us has various threads, by which the fabric of humanity is woven to keep the beauty of the world alive. This unique attire that unites the whole people together is strictly knit on marvelously arranged variety of threads, which differ in colours and creeds. Here the diversity provides the ultimate visual attraction to this integration and unity.

It was a remarkable decision from the royal highness of Jordan for making the world peaceful, uniting various religions together with the Common Word between us, which was a strong foundation for wonderful formation of world Interfaith Harmony Week resolution of United Nations.

The whole world united together to observe the Week of Harmony and Tolerance, when HM King Abdullah II of Jordan proposed a World Interfaith Harmony Week at the Plenary Session of the 65<sup>th</sup> UN General Assembly in New York on September 23, 2010. The proposal was adopted unanimously by the UN General Assembly in New York on the grounds that humanity bound together by the two shared commandments of 'Love of God and Love of the Neighbor' or 'Love of the Good and Love of the Neighbor'.

Religious groups and organizations join hands one another to spread the message of harmony and tolerance. The presidents and prime ministers of various countries play vital role in uniting the world order for a unique cause.

Based on the same objectives of the World Interfaith Harmony Week, International Islamic University Malaysia will collaborate with Department of National Unity, Prime Minister Department, Malaysia and Ma'din Academy, India to hold an International Seminar on Interfaith Harmony & Tolerance and Award Ceremony on Tuesday, 26<sup>th</sup> February 2013 in International Islamic University Malaysia, Gombak Campus and a Harmony Visit Programme on February 27<sup>th</sup> Wednesday and 28<sup>th</sup> Thursday at Department of Unity, Putra Jaya and Malacca respectively in connection with United Nations Interfaith Harmony Week.

The international seminar endeavors to promote the ongoing discussions and debates on tolerance among the religions, communities and groups and to open an avenue for further discussions on interfaith harmony and tolerance. This will surely be point for dialogue,

cooperation and worldwide co-ordination between major scholars. This venture will be part of United Nations proposal for historic meetings, conferences and dialogue.

The primary objectives of the seminar are to spread the message of harmony and tolerance among the followers of religions, faith and beliefs. This year seminar papers and discussions concentrates on major areas media and international relation, It aims to promote the common basis of “Love of God and Love of the Neighbor” or “Love of the Good and Love of the Neighbor” to o strengthen the message of harmony and tolerance, which is necessary to reduce anxiety, stress and personal pressure among individuals, society and countries.

The World Interfaith Harmony Week is not a call to water down one’s faith, but rather it’s a call to respect our differences and personal beliefs and to unite around the basic principles that people of all beliefs agree upon and to understand that harmony can only come if we build upon a solid foundation of dialogues.

It is hoped that this initiative will provide a focal point from which all people of goodwill can recognize that the common values they hold far outweigh the differences they have, and thus provide strong measures of peace and harmony.

### **The Initiative**

This initiative will discuss uniting the mindset of people and encouraging tolerance. This seminar co-ordinates and unites the efforts of all groups, doing positive work with one focused theme which increases collective momentum and eliminating redundancy.

This will permanently and regularly encourage the public to declare the peace and harmony. Moreover, teachers, students and researchers commit themselves on the record once in a year to peace and harmony.

We like to share our aims, objectives and encourage people to join in this UN sponsored World Interfaith Harmony Week.

### **Rationale**

The primary objective of the International Interfaith Harmony Award and Seminar visit is to spread the message of harmony and tolerance among the followers of religions, faith and beliefs. This venture recognizes the great efforts of those who contributed to the enhancement of interfaith harmony and tolerance in their own countries and beyond.

It also wishes to strengthen the message of harmony and tolerance, which is the necessity to reduce anxiety, stress and personal pressure. This, especially in a secular society, is the time demanding initiative.

The organizers hope that the theme will boost the ongoing discussions and debates on tolerance among the religion, communities and groups, and open a new avenue for further discussion on this matter can shed light to these matters.

### **Objectives**

1. To discuss uniting the mindset of people and encouraging tolerance.
2. To coordinate and unites the efforts of all groups, doing the positive work with one focused theme which increases collective momentum and eliminating redundancy.
3. To encourage the public to declare the peace and harmony.

### **Recognitions**

The moral imperatives of all religions, convictions and beliefs call for peace, tolerance and mutual understanding will be recognized.

This will reaffirm the mutual understanding and inter religious dialogue constitute important dimensions of a culture of peace.

It is also essential to resist forces of division that spread misunderstanding and mistrusts.

### **The Expected Outcome**



To recognize the moral imperatives of all religions, convictions and beliefs call for peace, tolerance and mutual understanding.

To reaffirm the mutual understanding and inter religious dialogue constitute important dimensions of a culture of peace

To resist forces of division that spread misunderstanding and mistrusts especially among people.

### **Interfaith Harmony Award 2013**

Interfaith Harmony Award 2013 will be given to Mr. Yasser Mohammad Abdo Yamani , Managing Director, Iqraa Foundation, Considering his contribution in the field of Harmony and Tolerance.

His illustrious vision to improve the current status of the world by eradicating the poverty, which can be highlighted in this moment: “Helping people is at the core of our Belief; you have to contribute to charity and do something in your community and in other communities in order to feel balance in your life.”

### **Ambassadors Conclave**

Ambassadors are the real representative to proliferate epitome of their counties vision and mission. Here we form a unique conclave of ambassadors’ for harmony and tolerance, which is one of the two very important sessions of the seminar.

Ambassadors of various countries will join together to think about harmony and tolerance among countries. This is an academic opening to harmony and tolerance among the nations and its cultures through their Malaysian ambassadors and high commissioners. This conclave will strongly think on the necessity of harmony among the nations and timely giving out of the great theme of harmony and whole heartedly supporting this great venture of United Nations Initiative.

### **Harmony Prospects and Media Perspective**

This is the era of new generation media, which play an important role in international politics and policy making. Media can change the world by contributing much to interfaith harmony and tolerance. The second round table session of the conference will be discussing the role of media in the prosperity of harmony and tolerance.

The media discussion will be exclusively based on topic ‘Harmony Prospects and Media Perspective’. This will be panel discussion attended by a number of media delegates from various countries to seriously think on what strategy of media can improve the harmony and tolerance among individuals, groups, societies and counties.

This will be relaying on the right way to spread the inevitable lessons of harmony and tolerance to the general public. It is a creative discussion focusing on the view points of media and the value of spreading message of harmony particularly to the individual and the society in general.

**Abbas Panakkal**, PhD, Muslim,  
GHA Vice-President,  
Coordinator, International Seminar on Interfaith Harmony and Tolerance, Malaysia,  
Professor, Ma’din Academy.

**Address:** Vegara, India

**E-mail:** [apanakkal@gmail.com](mailto:apanakkal@gmail.com)

19/02/13

## 5. Need for Common Scientific and Educational Platform for Interfaith Harmony: *The ABC of Harmony*

If the internal harmony potential of religions is the first necessary condition for interfaith harmony, which, obviously, is not enough for full interfaith harmony, then why is it not enough and what is needed in addition? Insufficiency of that potential lies primarily in its intuitive nature, i.e. in the limitations of intuitive knowledge, or intuition, with which is connected every religion and faith. In view of this, intuition and faith are often identified (see for example the article by M. Greaney below). Although intuition is a fundamental form of human knowledge, much wider than the faith and inseparable from another form of knowledge - the reason, which is most clearly expressed in science and philosophy. This is not the place to go into a deep philosophical analysis of the fundamental forms of human cognition. It is presented in more detail in our special article on the analysis of the Brahma Kumaris.

Here we focus on key point of this project GHA: **full and sustainable world interfaith harmony, which is required for a global harmonious civilization of the 21<sup>st</sup> century, is impossible without having in common for all religions, a scientific and educational platform in form of *the ABC of Harmony* and similar textbooks.** Only on this basis will it be possible to create a global harmonious education, which forms general harmonious consciousness of believers as the most profound and sustainable foundation for interfaith harmony. Of course, it goes without saying, as shown above: harmonious consciousness of believers may be in indissoluble unity, and as a supplement to the harmonious potential of religions. Interfaith harmony has equal needs in two cognitive foundations - in intuition and science, in their organic unity and complementarity, without which it is always incomplete, limited and flawed, as it was until now.

A key point of this project, which expresses the GHA mission and philosophy found in scientific evidence and detailed development in the GHA program by 76 authors from 26 countries:

*The ABC of Harmony for World Peace, Harmonious Civilization and Tetranet Thinking*, Global Textbook, by Dr. Leo Semashko, Project Manager, Editor in Chief and GHA 75 coauthors from 26 countries: first published in English in India, New Delhi, Doosra Mat Prakashan, 2012, 334 pages, ISBN – 978-81-923108-6-2. The book is submitted also in the two electronic formats: [www.peacefromharmony.org/?cat=en\\_c&key=478](http://www.peacefromharmony.org/?cat=en_c&key=478) – HTML and [www.peacefromharmony.org/file/6079/ABC\\_of\\_Harmony\\_eng.pdf](http://www.peacefromharmony.org/file/6079/ABC_of_Harmony_eng.pdf) - PDF.

The authors' 27 reviews are at: [www.peacefromharmony.org/?cat=en\\_c&key=489](http://www.peacefromharmony.org/?cat=en_c&key=489)

The book may be ordered at: [www.peacefromharmony.org/?cat=en\\_c&key=508](http://www.peacefromharmony.org/?cat=en_c&key=508).

*The ABC of Harmony* is represented in all the continents in the libraries of hundreds of educational institutions: schools, colleges and universities, as well as by the GHA members and friends in dozens of countries. It was nominated for the most prestigious international awards.

*The ABC of Harmony* was prepared within GHA in 2011 and published in early February 2012 in Russian in St. Petersburg and in English in New Delhi, India. Among its 76 co-authors are prominent scientists, peacemakers, artists and politicians: former President of India, Dr. Abdul Kalam; architect of Ronald Reagan's economic reform, Dr. Norman Kurland; head of the international organization of doctors (IPPNW), which received the Nobel Peace Prize in 1985, Prof. Ernesto Kahan; Chancellor of the Pedagogical IASE Deemed Gandhi University, Kanak Mal Dugar; Catholic Professor and the UN agent, Dr. François Houtart; President of World Esperanto Association, Prof. Renato Corsetti; President of International Association of Educators for World Peace, Prof. Charles Mercieca; President of International Forum for Literature and Culture of Peace, Prof. Ada Aharoni; President of "World Constitution and Parliament" Association, Prof. Glen Martin; prominent Russian Professors: Vladimir Bransky, Gregory Tulchinsky, Alexander Subetto, Dimitry Ivashintsov and many others. Five co-authors have the GHA's highest honorary title: World Harmony Creator as explained at [peacefromharmony.org/?cat=en\\_c&key=513](http://peacefromharmony.org/?cat=en_c&key=513).

Almost all of the ABC of Harmony coauthors are believers and representatives of dozens of denominations of all world religions, so this book is a vivid example of conscious interfaith harmony on the basis not only of religious intuition but and scientific understanding of harmony.

The outstanding American philosopher Dr. Glen Martin gave the shortest but very full definition for this book: *the ABC of Harmony* is “*Our New Planetary Paradigm, the fundamental revolution in science and paradigm shift in human consciousness*” (p. 296).

*The ABC of Harmony* is the first book of this kind in the world and the first global textbook on social harmony for all nations, governments, presidents and the United Nations. *The ABC of Harmony* is unprecedented in world history as a scientific and spiritual peacemaking instrument with the mission to achieve world peace from conscious social harmony through a global harmonious education and enlightenment in the ABC textbook.

The presentation of this book at the International Seminar of Teachers in New Delhi on February 11, 2012, marked the beginning of a new era of humanity: the Age of Harmonious Enlightenment and Education, which aims to overcome the total ignorance of past history in regard to social harmony ([www.peacefromharmony.org/?cat=en\\_c&key=511](http://www.peacefromharmony.org/?cat=en_c&key=511)). *The ABC of Harmony* is the theoretical basis of all 42 projects of GHA, including this project. These projects reveal its practical meaning.

*The ABC of Harmony* has fundamental theoretical value for the project to solve its global challenges: to achieve a world interfaith harmony. *The ABC of Harmony* is its overall scientific and educational platform. Its key content on 12 pages is presented in Appendix 1 to this project (see below).

Michael D. Greaney

## Religion and the Interfaith Harmony for Harmonious Economy. Is Faith or Reason the Basis of Economic Justice and Global Harmony?

In the late eighteenth century there was a split in classical economics. The split occurred between the followers of Adam Smith (1723-1790) and the followers of David Ricardo (1772-1823). This was on the question of what constitutes “money.”

### **Two Different Ideas about Money**

According to the economic thought based on the theories of Ricardo, “money” consists exclusively of coin issued by the government, and State-emitted or authorized banknotes (“bills of credit”) and their substitutes, such as checks. According to the economic thought based on the theories of Smith, “money” consists of anything that can be accepted in settlement of a debt.

The mainstream schools of economics (the Keynesian, the Monetarist/Chicago, and Austrian) and all their offshoots — and thus, as far as we know, the monetary and fiscal policy of every government on earth — assume that Ricardo’s definition of money is correct. Money is either existing wealth (preferably in the form of gold and silver coin or some substitute thereof) — “past savings” — owned by private citizens, or general claims issued by the State against that existing wealth.

Through a complicated genealogy, both the capitalist and the socialist systems derive from the ideas of Ricardo. This may explain why both capitalism and socialism tend to be dependent on existing accumulations of savings (what Louis O. Kelso and Mortimer J. Adler called “past savings”), and merge into what Hilaire Belloc called “the Servile State.”

Capitalist monetary theory is based on the assumption that the State does not have the right to issue claims against existing wealth. Money, therefore, should consist exclusively of accumulated private wealth or claims against existing private wealth on deposit in some financial institution. This limits ownership of capital to small private elite.

Socialist monetary theory is based on the assumption that only the State has the right to issue claims against existing wealth. Money, therefore, should consist exclusively of State-issued

coin, certificates representing a claim against State-owned wealth held in the Treasury, or certificates representing general claims issued by the government against ostensibly privately owned wealth of which the people through the State are the ultimate owner [1].

Monetary theory based on the principles of Adam Smith as corrected and expanded by Henry Thornton (1760-1815, the “Father of Central Banking”) and Jean-Baptiste Say (1767-1832, of “Say’s Law of Markets”) survives today only in “binary economics.” Binary economics is the school founded by Louis Kelso and Mortimer Adler. It was presented in their two collaborations, *The Capitalist Manifesto* (1958) [2] and *The New Capitalists* (1961) [3]. Given the reliance of both capitalism and socialism on the economic theories of David Ricardo and the presumed necessity for existing accumulations to finance new capital formation, the subtitle of the latter is significant: “A Proposal to Free Economic Growth from the Slavery of Savings.”

Binary monetary and fiscal policy is based on the realization that, just as all money is a contract, that is, a promise, all contracts are, in a sense, money. All contracts consist of offer, acceptance and consideration. “Consideration” is the inducement to enter into a contract, that is, whatever of value is being conveyed by the contract.

In accordance with the natural rights of private property and liberty (freedom of association/contract), any competent person can make an offer involving something of value. If the offer is accepted, money has been created. If the offer is not accepted, money has not been created. In a harmonious society, contracts — promises — are honored, and not changed or diluted at will by the State or private elite

### **The Role of Religion in Civil Society**

This discussion about the idea of money may seem an unimportant or trivial issue, or even a diversion. It seems especially so in a twenty-first century faced with the paradox of unparalleled productive capacity clearly out of harmony with massive personal and national debt, a global depression, and widespread want. When, however, we examine the assumptions behind the two definitions of money, we realize something more profound.

How we define money, while the immediate source of the difficulty, is actually a symptom of a much deeper problem that has afflicted the modern world for centuries. That is confusion over the respective roles of faith and reason. Faith and reason are intended to operate in harmony with one another, but have been put into conflict.

With respect to civil society — “the world” — the job of religion is to teach people the principles they need to achieve a harmonious relationship with other individuals, groups, and institutions. Whether organized or personal, the goal of religious belief (again, with respect to civil society) is to bring individuals and institutions all the way up to the State itself into harmony with essential human nature. As Alexis de Tocqueville described what he observed in the United States in the 1830s:

*“The sects, which exist in the United States are innumerable. They all differ in respect to the worship which is due from man to his Creator, but they all agree in respect to the duties which are due from man to man. Each sect adores the Deity in its own peculiar manner, but all the sects preach the same moral law [i.e., the natural law] in the name of God. If it be of the highest importance to man, as an individual, that his religion should be true, the case of society is not the same. Society has no future life to hope for or to fear; and provided the citizens profess a religion, the peculiar tenets of that religion are of very little importance to its interests.”* [4].

Thus, the role of organized religion with respect to civil society is to teach people and institutions — including governments — the precepts of the natural law, as that term is understood in the philosophy of Aristotle, updated and expanded by Aquinas, Maimonides, and Ibn Khaldûn, and establish and maintain harmony in civil society. This baffles many people, for the role of organized religion with respect to religious society is to teach people what a particular religion accepts as having been revealed by a god or gods, and to bring individuals into harmony with whatever god or gods they worship.

When we combine religious society and civil society, or (worse) try to base our science on religious truth or our religion on scientific truth, we end up undermining both faith and reason — and lay the groundwork for the totalitarian, servile State. Both scientific and religious truth are true, and true in the same way as everything else that is true, but the truths of each apply in different areas to different things. It is a serious mistake to try and make one do the work of the other.

### **Faith-Based Economics v. Reason-Based Economics**

Nowhere is the disharmony between faith and reason more evident than in economics and finance. There are other areas in which the confusion is more important, such as in philosophy and theology. Most people, however, simply do not care about what they regard as theological or philosophical hairsplitting, however important or beneficial — or disastrous — the results of this presumed hairsplitting may be. Most people tend to take what other people in authority say for granted, as long as what the person saying it seems to be plausible or have the right kind of authority.

Take, for example, a comment that someone posted in late December 2012 on the “Just Third Way” blog of the Center for Economic and Social Justice (CESJ). Someone asked if we had ever reviewed *Redeeming Economics: Rediscovering the Missing Element* (2010), a book by John D. Mueller. According to the commentator, the book “exposes the deficiencies of Classical and Neoclassical economics which stem from the deterministic Stoic philosophy of Adam Smith.” Again according to the commentator, Mueller “points out that the Scholastic philosophy of Aquinas’s works, whereas the ‘Father’ of economics produced unworkable economic theory.”

According to information gleaned from the internet, Mueller is the Lehrman Institute Fellow in Economics and Director of the Economics and Ethics Program at the Ethics and Public Policy Center in Washington, DC. His writings have appeared in the *Wall Street Journal*, the *Weekly Standard*, the *Washington Post*, and the *Harvard Business Review*.

We have not read Mueller’s book — but then, he evidently has not read any of ours, either. Everything in this article regarding Mueller and his book is based on the very brief assessment in the comment posted on the blog. Mueller, however, appears to be a “Chesterton scholar” (he is a founder of the G. K. Chesterton Institute, now located at Seton Hall University in New Jersey, U.S.A.). The commentator’s assessment of Mueller’s book appears to be consistent with neo-distributist thought. (“Distributism” is a system proposed by Chesterton and Belloc. It is based on a preference for small, family-owned farms and businesses, and broadly owned large enterprises. Adherents of “neo-distributism” have, by and large, redefined what it means to own something and the meaning of “contract” by attempting in many cases to base their system on faith instead of reason.)

Astonishingly for someone familiar with the thought of Chesterton and (presumably) Hilaire Belloc, Mueller embodied a fatal flaw in his argument — still assuming that the commentator reported it accurately. Mueller avoided the real issue of whether what Adam Smith said is true. He focused instead on what he believed to be Smith’s personal belief system, and made his understanding of Smith’s religious beliefs the basis of his critique of classical and neo-classical economics. Mueller thereby fell into the trap against which Chesterton warned in *Saint Thomas Aquinas: The “Dumb Ox,”* Chesterton’s biographical sketch of the “Angelic Doctor”:

*“At the top of his fury, Thomas Aquinas understands, what so many defenders of orthodoxy will not understand. It is no good to tell an atheist that he is an atheist; or to charge a denier of immortality with the infamy of denying it; or to imagine that one can force an opponent to admit he is wrong, by proving that he is wrong on somebody else’s principles, but not on his own. After the great example of St. Thomas, the principle stands, or ought to have stood established; that we must either not argue with a man at all, or we must argue on his grounds and not ours. We may do other things instead of arguing, according to our views of what actions are morally permissible; but if we argue we must argue “on the reasons and statements of the philosophers themselves.” [5].*

Whether Smith was a Deterministic Stoic, Christian, or Satan worshiper is irrelevant. If we base our acceptance or rejection of Smith's school of classical economics — or anything else — on something other than its objective truth or falsity, then we have violated the fundamental precept of reason embodied in the natural law that applies to the whole of humanity, regardless of any particular system of belief. That is, good (truth) is to be done, evil is to be avoided.

### **The Fatal Flaw of Faith-Based Economics**

If we base our science upon anything other than what we can prove by reason to be true, we commit the “ultimate crime” against both faith and reason. We do this by shifting the basis of the natural law from what we can discern about human nature (in Catholic thought, a reflection of God's unchanging and unchangeable Nature, self-realized in His Intellect), and therefore discernible by the natural force of human reason alone, to something we accept as God's Will. This “Will” usually turns out to be our personal opinion, or our opinion of something that someone else who possesses a bigger club says is God's Will.

Consequently, far too many people today, especially economists, base their science on faith, and their faith on some form of pseudo science, such as Keynesian economics. They thereby corrupt both science and faith. This may be one reason why so many physical scientists claim that economics is not a science. Economists themselves promote this idea when they base their theories on something they accept on faith, not reason, e.g., disproved Keynesian dogma, such as the false idea that it is impossible to finance new capital without first cutting consumption, or that the State has the power to “re-edit the dictionary” (below).

The misapplication of faith to reason, and of reason to faith is (at least according to Pope Pius XII) the greatest danger to Catholic doctrine today — and, by extension, to all religion, organized or personal:

*“Disagreement and error among men on moral and religious matters have always been a cause of profound sorrow to all good men, but above all to the true and loyal sons of the [Catholic] Church, especially today, when we see the principles of Christian culture being attacked on all sides.*

*It is not surprising that such discord and error should always have existed outside the fold of Christ. For though, absolutely speaking, human reason by its own natural force and light can arrive at a true and certain knowledge of the one personal God, Who by His providence watches over and governs the world, and also of the natural law, which the Creator has written in our hearts, still there are not a few obstacles to prevent reason from making efficient and fruitful use of its natural ability. The truths that have to do with God and the relations between God and men, completely surpass the sensible order and demand self-surrender and self-abnegation in order to be put into practice and to influence practical life. Now the human intellect, in gaining the knowledge of such truths is hampered both by the activity of the senses and the imagination, and by evil passions arising from original sin. Hence men easily persuade themselves in such matters that what they do not wish to believe is false or at least doubtful.” [6].*

This also goes in the other direction — forcing your science to fit theories based on faith leads directly to totalitarian control of science. As Dr. Leo Alexander pointed out in his article “Medical Science Under Dictatorship” in the July 1949 *New England Journal of Medicine*, basing pseudo science on a faith in the innate superiority of the supposed Aryan race was a primary tool the Nazis in Germany used to impose their genocidal eugenics programs.

### **The Basis of the Totalitarian, Servile State**

It comes as no surprise that, in order to make a faith-based economics work, there is always — *always* — a resort to coercion in one form or another, almost invariably by the State, or something (or someone) that takes the place of the State. This is consistent with the observations of both the Aristotelian philosopher Mortimer Adler [7] and the solidarist Heinrich Rommen [8] that turning away from reason and basing your science on faith, or your faith on science, leads directly to totalitarianism.



This is an observation borne out by Harold Moulton in his analysis of the illogical premise that government debt can continue to grow to many times GDP without any danger to economic or political stability (below). Thus we should not be surprised when a public, bureaucrat-controlled “dictatorship of money” [9] replaces the despotic private dictatorship of money controlled by private interests.

We see the results of this “one twist to the mind” (i.e., the shift from reason to faith as the basis of the natural law) in the political ideas of Walter Bagehot (*The English Constitution*), who sneered at *Magna Charta* and complained that the U.S. Constitution is flawed because it doesn’t allow for a dictator, and, especially, the economics of John Maynard Keynes, Bagehot’s disciple, who advocated government control of the economy, and who claimed [10], in the opening passages of the first volume of his *Treatise on Money* (1930) that the State has absolute power, even to the extent of being able to “re-edit the dictionary” . . . thereby (in Aristotelian philosophy) changing the substantial nature of reality.

For example, the Keynesian New Deal economist John M. Clark headed a chapter in *The Social Control of Business* (1939), his “unique textbook,” “If I Were Dictator,” [11] while Adolph Berle agitated for years for effective government takeover and the abolition of private property in capital. More recently, one so-called “Catholic economist” published an article declaring how he could solve all the world’s problems . . . if he were just given absolute power . . . [12]. We must always keep in mind that where faith-based economics contradicts scientific truth established by reason and empirically validated, it cannot work without the imposition of totalitarian controls, and usually not even then, as recent events have demonstrated.

As Dr. Harold G. Moulton pointed out in *The New Philosophy of Public Debt* (1943), his short analysis of the effect of Keynesian monetary and fiscal policy on the American economy, that as long as we absolutely insist on maintaining the Keynesian system, “It will be necessary to make a choice. With unlimited debt expansion we cannot prevent inflation without the use of totalitarian methods of control. No compromise or half-way measures can adjust the difficulties. The choice is between regimentation and inflation.” [13].

### **The Dangers of Totalitarian Economics**

As Moulton concluded his pamphlet after pointing out the fatal flaws in Keynes’s faith-based system (faith in Keynes and His Inner Light, that is), “Unless a stable system of public finance is maintained in the United States, and also in other countries, the foundation stone for international reconstruction will rest on quicksand.” [14].

Neo-distributists seem to be among the worst offenders with respect to basing their model economic system on faith, i.e., subjective opinion instead of objective knowledge. [15]. As a result of redefining the natural law, neo-distributists tend to insist that the system they advocate — usually bearing little, if any, resemblance to the distributism of Chesterton and Belloc— is a (or, more offensively to devout adherents of any faith, the) only true “Catholic” economic system.

This gives neo-distributists and adherents of other faith-based economic systems the religious crutch they desperately need to support their model and justify forcing their system on others. It also provides their inevitable fallback position when they find their system cannot work due to being based on past savings and a fundamental redefinition of the natural law: it is because the faith of other people isn’t strong enough, and the other people are heretics and dissenters from the presumably true faith.

Such people (and neo-distributists are only one group among many such offenders) ignore the fact that the Catholic Church explicitly repudiates the idea that there can be a “Catholic” system of economics. [16]. As the solidarist economist Franz Mueller stated, “[S]trictly speaking, it would be as incorrect to speak of Catholic sociology as to speak of Catholic economics.” [17].

### Why the System Does Not Work

It is not, however, due to lack of faith that the economy is not working harmoniously, or because Adam Smith was a “Deterministic Stoic,” or any of the “reasons” adduced so readily by people who never learned how to reason. These are all excuses.

The real reason neither the present system nor any of the faith-based systems demanded by so many people today do not work is because the principles of the system are inherently flawed, i.e., not true, as is the form of the argument. As Aquinas explained in his closing of his treatise, “On the Unity of the Intellect,” do not come prating to him that you are proving matters of science based on “documents of faith.” Instead, state your case rationally “using the arguments and teachings of the philosophers themselves”:

*“This then is what we have written to destroy the error mentioned, using the arguments and teachings of the philosophers themselves, not the documents of faith. If anyone glorying in the name of false science wishes to say anything in reply to what we have written, let him not speak in corners nor to boys who cannot judge of such arduous matters, but reply to this in writing, if he dares. He will find that not only I, who am the least of men, but many others zealous for the truth, will resist his error and correct his ignorance”.* [18].

In other words, present your evidence and give a sound argument. Vest your case with logical consistency and empirical validity. Do not rely on delivering a tirade against people with whom you disagree and about whom you can invent “facts” and insinuate unspecified crimes, but cannot give any rational basis for your hatred. “Non amo te, Sabidi” is not a reason, but an intellectually dishonest excuse. Calling someone a bad Catholic, Jew, Muslim or anything else because his or her economics does not suit you or your religious beliefs, or because his or her religion doesn’t agree with your economics, is utter nonsense, and is against the principles of reason and the natural law that necessarily lay the foundation for a harmonious economy and society.

### References

1. Thomas Hobbes, *Leviathan*, (1651) II.24.
2. Louis O. Kelso and Mortimer J. Adler, *The Capitalist Manifesto*. New York: Random House, 1958.
3. Louis O. Kelso and Mortimer J. Adler, *The New Capitalists*. New York: Random House, 1961.
4. Alexis de Tocqueville, “Religion Considered As A Political Institution, Which Powerfully Contributes To The Maintenance Of The Democratic Republic Amongst The Americans,” *Democracy in America*, I.xvii.
5. G. K. Chesterton, *Saint Thomas Aquinas: The “Dumb Ox.”* New York: Image Books, 1956, 95-96.
6. Pius XII, *Humani Generis* (“Concerning Some False Opinions Threatening to Undermine the Foundations of Catholic Doctrine”), 1950, §§ 1-2.
7. Mortimer Adler, “The Nature of the Natural Law,” [www.faculty.umb.edu/gary\\_zabel/Courses/Morals%20and%20Law/M+L/adler\\_naturallaw.html](http://www.faculty.umb.edu/gary_zabel/Courses/Morals%20and%20Law/M+L/adler_naturallaw.html), accessed January 7, 2013.
8. Heinrich Rommen, *The Natural Law*. Indianapolis, Indiana: Liberty Fund, Inc., 1998, 134-138
9. Pius XI, *Quadragesimo Anno* (“On the Restructuring of the Social Order”), 1930, §§ 105-106
10. *General Theory of Employment, Interest, and Money*, VI.24.iii.
11. John M. Clark, *Social Control of Business, Second Edition*. New York: McGraw-Hill Book Company, Inc., 1939, 520-525.
12. Rupert J. Ederer, “If I Were King of Poland,” *Fidelity* magazine, May 1990.
13. Harold G. Moulton, *The New Philosophy of Public Debt*. Washington, DC: The Brookings Institution, 1943, 88.
14. *Ibid.*, 93.

15. Cf. Mortimer Adler, "Knowledge and Opinion," *Ten Philosophical Mistakes: Basic Errors in Modern Thought*. New York: Macmillan Publishing Company, 1985, 83-107.
16. John Paul II, *Centesimus Annus* ("On the Hundredth Anniversary of *Rerum Novarum*"), 1991, § 43.
17. Franz Mueller, "Preface" to Dr. Wilhelm Schwer, S.T.D., *Catholic Social Theory*. St. Louis, Missouri: B. Herder Book Company, 1940, vii.
18. Thomas Aquinas, *De Unitate Intellectus Contra Averroistas*, § 124.

**Michael D. Greaney**, CPA, MBA; Catholic faith,  
GHA Embassy Co-Director, Human Rights from Harmony and Justice, Ambassador  
Center for Economic and Social Justice (CESJ).

**Address:** P.O. Box 40711, Washington, DC 20016, USA

**O:** 703-243-5155

**F:** 703-243-5935

**Web:** [www.cesj.org](http://www.cesj.org)

**E-mail:** [thirdway@cesj.org](mailto:thirdway@cesj.org)

23/01/13

### **Editor's Note**

#### **The Significance of Interfaith Harmony for Harmonious and Just Economy**

As we can see from the previous statement, valuable for the harmonious economy and society is not religion itself, and interfaith pluralistic harmony of religions together with pluralistic and harmonious synthesis of all religious achievements, useful for harmony and justice, without exception. This is the key conclusion of my paper.

Yes, the one ground of reason and science for harmonious and just economy is not enough, because of their moral and spiritual limitations. But this is not enough for it and the ones religious and intuitive grounds, because of their scientific and rational limitations. Moreso, it is inadequate, not enough and vicious the absolutization of one religion as "the single absolute support of the economy and society." This leads to the dictatorship, violence and eternal war and eliminates any possibility for world peace. Therefore, there exists a unique foundation - an interfaith harmony, based not only on their own harmonic potential, but also on the scientific basis of *the ABC of Harmony* ([www.peacefromharmony.org/?cat=en\\_c&key=478](http://www.peacefromharmony.org/?cat=en_c&key=478)), widely represented in this project in this function. We fully support it and join it. This project and its religious and scientific grounds constitute the necessary intellectual environment in which only can be understood the basic meaning of this article.

This project has the theoretical and practical importance in understanding the need for interfaith harmony the harmonious and just economy, and in understanding the reverse need for harmonious and just economy for interfaith harmony. One can not exist without the other, as the other can not exist without the first. It is a single, indissoluble, pluralistic and harmonious in all senses, process.

**Dr. Leo Semashko**

Michael Ellis

Globalisation of Interfaith Harmony through *the ABC of Harmony*.  
Religion, Ecology and Globalisation in the 21<sup>st</sup> Century

The world's religious believers who make up the majority of humankind, have, as a group, been cautious about making changes towards a more sustainable planetary future. Harvard University's Forum on Religion and Ecology (<http://environment.harvard.edu/religion/>)

is the largest international multireligious project of its kind. The overall aim of its work is to find what connects rather than what separates us in terms of religions and ideologies. The environmental crisis, especially the loss of biodiversity, highlights our need to connect with the common ground of our interconnectedness with all of life and the need to highlight our deep respect for the sacredness of all of life. Interfaith harmony is an ability to reconnect our spiritual aspirations with our common ground of connectedness through the life affirming qualities of new ways of thinking, being and acting which can save our species from being irretrievably mutilated by our own actions.

Most of our great religious figures, appeared in an axial development two and a half thousand years ago, coined the Axial Age by the German philosopher Karl Jaspers. Around this time, we see the development of Judaism, Buddhism, the philosophy of Socrates and Plato Zoroastrism, Jainism and also the foundations of monotheism were laid in the West. In the East, the inclusive compassion of the Buddha which states seek your salvation within yourself with diligence was established. This age was a pivotal moment in Humankind's history bringing out of the chaos of multitude of animistic beliefs a central interfaith harmonious principle based on the connectedness of all of life and an expression of a comprehensive compassion.

The current religions in the world as they stand, still live by the ethos and cultural proclivity in which they were proclaimed and have not yet risen to face the enormous changes of a more inclusive, interconnected global society, which we now live in.

### **Science, Religion and Consciousness and Interfaith Harmony**

Science itself is gradually unraveling the nature of consciousness, and a deep relationship with the infinite intelligence of universe, particularly quantum physics, which is the basis of the new biology, and the new medicine. Indeed, evolution is not a random event, but has purpose in it. In this respect, the universe is a biological self-referential evolving creative system. We live in a co-operative living matrix, in which everything maintains itself at the expense of everything else. The universe is built and exists on energy in a quantum non local field. This quantum field is in its very nature, an expression of harmony and connectedness of all things representing a primary infrastructure for an understanding of interfaith harmony

Humanity exists to cooperate in communication units and systems. We are all cells in a living matrix of consciousness.

This understanding of consciousness comes with thousands of experiments, which prove extra sensory perception remote viewing, synchronicity and the effects of mind on the environment. This is in addition to the ability of the mind to create coherence with heart and brain and body, in order to cure virtually any illness under the sun. The ability of thousands of people in coherent meditation to affect critical mass in terms of positive changes in society has been documented in many transcendental meditation studies.

The key ultimately is kindness. We need to be able to love each other and care about each other, as the family of planetary Humankind.

Can our religions make a quantum jump at this time, when our planet is at tipping point and severe mutilation of all living species, including human beings, could occur? *The ABC of Harmony* in the GHA during 8 years ([www.peacefromharmony.org](http://www.peacefromharmony.org)) is a metaphysical expression of an approach creating harmony between all religions seeing what they have in common rather than what separates them. Indeed *the ABC of Harmony* encourages an integrative approach to all religions defining a harmonious ecumenism, and enhancing the interreligious political decisions at the level of the United Nations (the UN Resolutions on the harmonization of relations between religions).

What is needed is the awakening of a new consciousness and creativity to the challenges posed by the deep crisis that humanity now faces. We are at the summit of 6.5 billion years of evolution. Our biosphere and planet are now on the sixth phase extinction of biodiversity, which is occurring at 30,000 species a year. The last time that this occurred was 65 million years ago,

with the extinction of the dinosaurs. Humanity is now an endangered species. The promotion of interfaith harmony is a crucial stepping stone to healing humanity.

The religions of the world now have to deal with new scenarios which are global and ecological and in which our very lives are threatened. *The ABC of Harmony* can place a new perspective on a way of living which respects all of life through a science of harmony and integration enhancing interfaith dialogue and understanding.

*The ABC of Harmony* has a role to play in enhancing our combined humanity to reach a place and common ground, where our religions can come together to enhance human values and express a deep regard and love for all humanity and living species and an affirmation of and celebration for all of life.

### **We Need a New Vision to Unite Humanity through Interfaith Harmony**

Can we indeed become responsible stewards of the planet, seeing ourselves as inextricably part of the great conscious cosmic network of life in which each one of us has a unique part to play in creating higher awareness, higher consciousness, creativity and love of life?

The GHA shows evidence that we are now reaching a new pivotal time or Axial Age in the history of humanity, by citing hundreds of facts: the development of the harmonious society in China and European Union; the recognition of the “nuclear zero” in the USA and Russia in 2009; the renunciation from violence of Mahatma Gandhi in India’s independence from Great Britain; Japan’s decision after World War II to use military forces only for self defense; the fact that Costa Rica doesn’t have an army, the Universal Declaration of Human Rights, the Declaration of Religious Harmony of Singapore, which affirms Singaporeans commitment to religious harmony, and others. GHA states that many of the similar facts are collected and published by the Global Harmony Association (GHA) in the project: “Epoch of Harmony Globalization” ([www.peacefromharmony.org/?cat=en\\_c&key=382](http://www.peacefromharmony.org/?cat=en_c&key=382)). All of these governmental decisions, proclamations and declarations support the value of *the ABC of Harmony* as a new way to harmonize religions and relations between them.

There is also the development of new disciplines and understandings of religion and ecology, science and religion, holistic medicine, holistic education, involving the environment and also ecological economics, especially the work of Hazel Henderson who is a world expert on futurism and new economics.

A new consciousness will need to encompass a Meta paradigm which brings together a more unified understanding of our place in the universe. *The ABC of Harmony* is an expression of the significant underlying philosophical approach to the Meta paradigm of the new millennium. The outstanding American philosopher Glen Martin gave the shortest but full definition for the book: *the ABC of Harmony* as “*Our New Planetary Paradigm, the fundamental revolution in science and paradigm shift in human consciousness*” (p. 296).

*The ABC of Harmony* as a philosophy challenges and goes beyond present day assumptions of the modus vivendi of our prevailing way of life based on the philosophy of economic rationalism. This form of thinking has been called triadism and has led to the imminent collapse of the human society as we know it. Triadism is the cornerstone of the old paradigm which erroneously seeks for infinite exploitation of the Earths finite resources and places faith and religion as completely separate from science and in many ways negates the concept of interfaith harmony.

Three thousand years ago at the time of the first Axial period, Shakymuni Buddha introduced as his penultimate teaching – the Lotus Sutra often considered the Bible of all Buddhist teachings. In the Lotus Sutra, the law, represents the re conciliation of apparent opposites, such as existence and nonexistence, life and death, Yin and Yang, spirit and matter, the seen and the unseen and yet, has at its basis, a vibrant, flowing, powerful, clarifying power, which is total reality. The law, in the Lotus Sutra, is therefore a dynamic vibrant ocean of



perpetual life and affirmation. One of the great exponents of this understanding was the great master Tien Tai. He taught the great emperors of China around 300 to 400 AD. Nichiren Dai Shonin in thirteenth Century Japan expressed the ultimate principle of the truth and the law as Nam Myoho Renge Kyo ([www.buddhistcentre.net](http://www.buddhistcentre.net)) a spiritual path which is followed by thousands of people throughout the world.

Nichiren Dai Shonin in his teaching - The Entity of the Mystic Law states: *The Great Teacher Dengyo, explaining the lotus of the "one great reason" [why the Buddha appears in the world], writes: "The 'one great matter,' the true heart and core of the Lotus Sutra, is the revelation of the lotus. The word 'one' signifies that it is the one reality. The word 'great' signifies that it is broad and all-encompassing in nature. And the word 'matter' refers to the essential nature of phenomena. This one great reason or 'ultimate matter' is the truth, the teaching, the wisdom and the practice of the perfect teaching, or the Dharma body, the wisdom and the emancipation of the perfect teaching. Through this, the persons of the one vehicle, those of the three vehicles, those of the determinate groups, those of the indeterminate group, those who believe in Buddhist teachings, those who believe in non-Buddhist teachings, those who have no desire to become Buddhas, and those who are unable to believe in the correct teachings--all of these beings, every one of them, are brought to the realm of the wisdom penetrating all phenomena. Thus, this 'one great reason' opens the door of Buddha wisdom to all beings, shows it, causes them to awaken to it and induces them to enter into it, and all of them attain Buddhahood."*

- The teaching representing the ceaseless current of the creative power of life is a basis for interfaith harmony

The natural, logical conclusion of this search in the first Axial revolution, three thousand years long, was an attempt to define the harmonious mind and its abilities with the number four – a tetradic group of four. The key to tetradic group of four in Buddhist teachings is the concept of the law. This law is also called, the Dharma. The Dharma also represents the middle way. The middle way, as expressed by Nichiren, Tientai and Nagarjuna represents a tetralemma. Nagarjuna, was the founder of the Madhyamaka school of Mahayana Buddhism. Nagarjuna applied the tetralemma to questions such as those regarding the existence of the self, and the true nature of reality. The true nature of reality can also be called the ultimate truth or principle or God and thus has many names but one inclusive foundation as the basis for interfaith harmony

The teaching of the law representing the attainment of enlightenment in the Human Mind is part of the perennial search for the true nature of the human psyche and the true nature of reality. This true nature of reality in Buddhist terms is Non-dual knowledge of the ultimate nature of both mind and phenomena called Enlightenment. Enlightenment is also called the State of supreme knowledge combined with infinite compassion.

The philosophy of the pluralism of the tetradic harmonious thinking is unfolded scientifically in *the ABC of Harmony*, and contributes to the understanding of the nature of Enlightenment expressed in Buddhism and all esoteric Spiritual paths. This philosophy having its roots in Buddhist spiritual wisdom and united with modern and global scientific tetradic harmonious thinking can be an effective foundation for interfaith harmony in the 21<sup>st</sup> century through globalization of harmonious education.

**Michael Ellis**, MD, BA (Hons), Buddhist faith,  
GHA Ambassador of Peace from Harmony for Australia,  
Doctor of Medicine,  
President, THE GLOBAL PEACE CENTRE  
**Address:** Melbourne, Australia  
**Web:** [www.peacecentre.org](http://www.peacecentre.org), <http://vergemm.com/>, [www.xcellentu.com](http://www.xcellentu.com)  
**E-mail:** [mindquest@ozemail.com.au](mailto:mindquest@ozemail.com.au)  
23/1/2013

Kurt Johnson

## The Interspiritual Age of Interfaith Harmony

I am truly grateful for this opportunity to share a note about World Interfaith Harmony week and GHA's theme of "Peace from Harmony". I was quoted recently as saying "when world religions find their authenticity, they find their unity!" I recall it because it captures the understanding that there is a central core within all the world's spiritual traditions — best called simply "the Heart" — in which the lens of unconditional love automatically brings people together in peace.

We can actually distinguish "Spirituality" and "Religion" in this way. True spirituality is unconditional in its view from the Heart. It loves without regard to circumstance — the message of all the great saints and sages. As David Ord and I say in our recent book *The Coming Interspiritual Age* (which has caught so much attention!) religion is the offspring of spirituality but, because of often unavoidable cultural circumstances, religion can lose this unconditional lens and become more about "who is right" — in religions' more precise stories and narratives about reality, dogmas and creeds.

This is perhaps the central conundrum of our time, as our planet moves inevitably toward globalization and a multicultural world civilization. If religions put their emphasis on whose narrative is "right", as opposed to the lens of Heart's unconditional love — taught by all the traditions — we may have some serious trouble! In fact, we already do! Most scientists today believe that this conundrum is actually an "anthropological threshold" in our evolution. Will our species, *Homo sapiens*, reach a level of Love by which religious, nationalistic, ethnic, racial and other parochial narratives (inevitable but problematic) can become secondary to the rule of Love itself?

We can imagine that if an extra-terrestrial came to visit us and secretly reported back to their home planet, they might also identify this as earth's central challenge today. Would they report that globally we evolved to put love over ideas? Or would they report that, sadly, we fell victim the rule of mind over heart, and ended up in a cataclysm of competition, conflict and war? It's a fair question to ask and it's the central question of our time. Its answer will determine our destiny.

Today's "interspiritual movement" — named "interspiritual" by the famous ecumenist Bro. Wayne Teasdale in his now classic book *The Mystic Heart: Discovering a Universal Spirituality in the World's Religions* (1999) — is a culmination of our planet's centuries long voyage toward a trans-traditional spirituality. The only viable religion for the Third Millennium, Teasdale said, was "spirituality itself". And, in true spirituality, Teasdale emphasized, there is plenty of room for myriad diversity within the inherent unity of the Heart's unconditional ability to love. This is a tall order for modern man. Yet, as we note in *The Coming Interspiritual Age*, and as is recounted in myriad books we could all name, this has been the message of all the great voyagers on this path — to name only a few: Ramakrishna, Vivekananda, Sri Aurobindo and The Mother, Teilhard de Chardin, Raimon Panikkar, Bede Griffiths (Dhayananda) among thousands of others we all revere.

Teasdale challenged us with this entreaty: "We need to understand, to really grasp at an elemental level that the definitive revolution is the spiritual awakening of humankind" (*The Mystic Heart*, p. 12). And this is the awakening that puts love, and deed, over creed. It is the central question whether our species can reach this level of spiritual maturity. Yet, it is the entire message underlying what has evolved as the world's ecumenical, interfaith, and now "interspiritual" movements. It is the clarion call of our time, as reflected in words like "trans-cultural", "trans-traditional", "trans-national" and "world-centric".

A part of this global approach is attention to all the arenas of civilization which must contribute to a skillfully transformed modern world — science, technology, economics, social



structures, governance and enlightened planning for our future from multiple perspectives and expertise. This is why we treat all of these in *The Coming Interspiritual Age* as well.

The work of World Interfaith Harmony Week, as championed by the Global Harmony Association and so many other organizations and NGO's of which many of us are a part, is central to this work. May we spread this message of unconditional love, from the Heart of all the traditions, in the hope that our path of evolution will show us how we can create a world reflecting that love within the complex diversity that now characterizes our planet.

**Rev. Dr. Kurt Johnson**, co-author of *The Coming Interspiritual Age* (2013, Namaste Publishing). Ordained in three traditions and with a PhD in evolution, ecology, systematic and comparative biology Dr. Johnson was associated with the American Museum of Natural History for twenty-five years and now teaches at New York City's one Spirit Interfaith Seminary. GHA member. More can be learned at Wikipedia (Kurt Johnson, entomologist).

**Address:** New York, USA

**Web:** [www.isdna.org](http://www.isdna.org), [www.thecominginterspiritualage.com](http://www.thecominginterspiritualage.com), [www.namastepublishing.com](http://www.namastepublishing.com)

**E-mail:** [kurtjohnsonisd@yahoo.com](mailto:kurtjohnsonisd@yahoo.com)

29/01/13

Leo Semashko

## Intuitive Knowledge of Harmony in the God Doctrine of Brahma Kumaris and Harmony Science

### **Intuitive and scientific knowledge of harmony: mutual complementarity**

Universal and holistic harmony exists on different levels: at the individual level of the person, at the global and local social levels of human society and on an infinite level of the Cosmos, the Universe and God. It is clear that these levels are inseparable and exist only through each other, and mutually interpenetrate, including each other. This determines their infinite complexity and inexhaustibility of knowledge. Any knowledge of harmony is relative and limited, constantly extending, deepening and proclaiming in the historical process of human knowledge.

It is also natural that, for universal, holistic and infinite harmony, there is no single and absolute form of human knowledge that is necessary and sufficient for its knowledge. There are many forms of its private knowledge, necessary but not sufficient, each on its own. There are two main forms of its knowledge: intuition (including faith) and science (as one of the highest manifestations of reason).

**Intuition** (contemplation, flair, insight) – is the direct apprehension of truth without logical analysis based on imagination, empathy, and previous experience (*Wikipedia*). Intuition - is the knowledge of any event of harmony of any kind and level that does not require facts as the sole basis of knowledge and is based ultimately on historical collective experience of people. Intuition - is par excellence sensory, supersensible and super-rational perception, cognition and thinking.

**Science** – is theoretical systematization of objective knowledge, the basis of which is the collection of facts, their constant updating and generalization (*Wikipedia*). Science - is knowledge of only limited phenomena of harmony, about the circle of which a human may have the facts to confirm these phenomena, their properties and relationships. Science - is primarily theoretical mediated knowledge and thinking.

The dignity of intuition is its limitlessness and support of itself and the internal potential of knowledge. The dignity of science is in finiteness and support of the facts and of the external potential of knowledge. Science and intuition are necessary but not sufficient in any knowledge of any subject, including harmony.

Intuition is democratic, inherent and available for everybody, and science, as well as philosophy, is elitist, inherent and available to not many. But these higher forms of spirituality can become accessible to all through education.

**Intuition** covers the endless spiritual pyramids (qualities) of God, society and humanity. It aims to provide a wholeness and sensuality available in images representing the infinite harmony of God (the infinite point of light in Raja Yoga), a human (the soul as the point on the person's forehead) and society (moral values or good). At the level of communion with spiritual infinity, intuition unites and harmonizes people. This is its dignity and advantage in the knowledge of harmony. But intuition does not and cannot give universally accepted, even limited, knowledge of the structure of harmony on any level: God, society or human. As soon as there is a question among people regarding understanding of their structure, there always are dissenting opinions which divide people and lead them to misunderstanding and then to enmity and war. On this side, it leaves people disharmonious and disconnected and therefore weak in knowledge and creation of harmony. Therefore, intuition is not enough, is limited in its use and requires the addition of the science.

**Science** is able to cover, but only partially, the spiritual pyramids (qualities) of society, the person and his or her harmony. Infinite harmony of God, as well as the associated infinity of the soul and the highest moral values, is not available in science, which always has to deal with objects, limited facts. **God and His Harmony are not available to science on a scientific definition.** They are only available to the intuitive knowledge, the most advanced form of which is religious thought, including religious philosophy, and different beliefs, including Raja Yoga. But the infinite harmony of God, society and humanity is necessary for science as the support and symbol of its integrity, though not completely proven by facts and faith. God is a symbol of the highest spiritual harmony and ethics of science. This symbol is not available to science itself. Science without divine spiritual harmony loses its supreme guidance and meaning in understanding and knowledge of a limited harmony. That is why even a limited harmony of society and the person does not become a subject of science so far. Up to now there is no science or scientific theory of social and individual harmony, except Tetrasociology which appeared only three decades ago, and got its perfect expression in *the ABC of Harmony*, in 2012.

On the other hand, science without God, without a higher spiritual harmony, integrity and ethics, is easily converted from a positive into a negative and destructive tool that we see in the industrial society and its people. Industrial science and limited mechanical knowledge does not give them knowledge of their own harmony as their most important and useful knowledge. Therefore science is insufficient and limited in itself. It requires addition and synthesis with intuition, faith and God. This conclusion led me, as a scientist, in the Brahma Kumaris (BK: [www.bkwsu.com](http://www.bkwsu.com)), to intuitive knowledge of the infinite divine harmony, and for its use in the form of meditation in the scientific knowledge of limited social and individual harmony. Understanding and confidence in this – this is the main thing that gave me a retreat in BK and what enriched me most as a scientist.

But science alone is insufficient. Intuition and its understanding of social harmony are also insufficient and limited in themselves, so they require addition and synthesis with science. This is particularly evident in the case of the BK representations of social and individual harmony.

### **The necessity and insufficiency of the intuition of harmony in BK**

Intuition of harmony is presented in two BK books:

- "Harmony" (1995) in English, published here: [www.peacefromharmony.org/?cat=en\\_c&key=540](http://www.peacefromharmony.org/?cat=en_c&key=540)
- Brahma Kumar Jagdish Chander, *Building a Value-Based, Peaceful and Prosperous Society* (2000), published in English in the main fragments here: [www.peacefromharmony.org/?cat=en\\_c&key=543](http://www.peacefromharmony.org/?cat=en_c&key=543).

Moreover, the first book is almost entirely included in the second, so we'll only talk about it.

First, we must emphasize this book's undeniable merits as an intuitive masterpiece of social harmony, as the intuitive ABC of Harmony of 2000, 12 years before *the GHA ABC of Harmony* and as the BK intuitive sociology of harmony. For brevity, we shall call it the "BK Sociology."

The BK Sociology dignities, which determine its necessity and unity with the science (scientific sociology), are:

1. Definition of harmony as a "universal and holistic" uniting and defining any viable diversity, which is fully identical to its scientific definition in *the ABC of Harmony*. This provides a unity of its intuitive and scientific knowledge and understanding.
2. Definition of the existing society as a disharmonious and spiritually impoverished "Iron Age" with a priority of material wealth, which (this age) is to be replaced with the harmonious and spiritual (value-based) society as a "Golden Age" with a priority of spiritual values. *The ABC of Harmony* expressed a similar definition, but in scientific terms: the current civilization is industrial and disharmonious with priority on economy which is going to be replaced by harmonious civilization with priority on the spiritual culture of harmony.
3. Definition of harmony as "the Prime Value", which includes other values: love, unity, peace, justice, harmony, brotherhood, etc., which makes harmony by holistic value. A similar understanding of harmony develops in the scientific *ABC of Harmony*.
4. The dawning of the harmonious society/civilization or the "Golden Age" is impossible without appropriate, harmonious spirituality presented and developed in BK in Raja Yoga. Harmonious society requires, above all, the harmonious divine spirituality of all people, which can be acquired only through Raja Yoga in BK. Similarly, in *the ABC of Harmony*, the conscious and non-violent building of harmonious civilization is impossible without the harmonious spirituality presented and developed, first of all, in the theoretical science of social harmony - in Tetrasociology. Harmonious civilization requires, primarily, scientific knowledge of social harmony, which will get everyone in the schools and universities a global harmonious education through the study of *the ABC of Harmony*, which discloses this scientific knowledge.
5. The root cause of disharmony as a negative force that generates the defects and pathologies of society is ignorance of harmony and as a lack of knowledge of its infinite spiritual source - God. Similarly, in *the ABC of Harmony*: the main cause of disharmonious industrial civilization is its ignorance in the scientific (positive) knowledge of harmony and its neglect of this knowledge. It is expressed in the absence of this science and the inability to create one in industrial society. The social need in this science (as the ability of its development) will only appear together with the first signs of a harmonious civilization in the early 21<sup>st</sup> century, as defined in *the ABC of Harmony*. Only in this civilization will diversity, universality and integrity of social harmony correspond with the diversity, universality and integrity of its knowledge, which transcends its industrial partiality and fragmentation, achieving harmony in cognitive diversity, including harmony between intuition, faith and science.

We have named only the basic, fundamental, dignities of the BK intuitive sociology that define its social need and demand unity with the science of social harmony, with Tetrasociology presented and unfolded in *the ABC of Harmony*.

The insufficiency of BK intuitive sociology is expressed in its following qualities and definitions.

1. The main weakness and lack of BK intuitive sociology is individualist reductionism, expressed in the fundamental thesis: "change of human changes society" or "a person who positively changes, positive change society," etc. on this basis, at the center of its activities, BK accomplishes spiritual transformation of personality, individual, believing it is sufficient for positive societal transformation. Such individualistic reductionism cannot see specific social laws at different levels from the family to global humanity.

Society and humanity are not a mechanical sum of individuals - as well as social harmony, which is not a mechanical sum of harmonious persons. Therefore, even if each individual can have positive change and become harmonious, it will not lead to a positive change in the society, to the creation of a harmonious society, to harmonious change of its other parts: families, communities, professional groups, classes and other social groups, nations, peoples, and etc. Each person can become harmonious and peaceful, and the groups and classes of people can remain hostile, mired in wars, in social disharmony and pathology. We see this today in many facts. Individual harmony must be supplemented by social harmony in the form of a harmonious organization and order in all other parts of society: spheres, sectors, industries, businesses, families, regions, etc. This requires the special scientific knowledge presented in *the ABC of Harmony*.

2. BK intuitive sociology distracts from making a single structuring, systematization and ordering of society as a social organism. It talks about society at the level of traditional everyday concepts, which lead naturally to the intuitive approach which neglects scientific analysis and theoretical generalization. The ordinary concepts of everyone are special. Hence on their level there cannot be unity in the understanding of social phenomena. Intuitive sociology does not give a clear, detailed and generally accepted answer about the structure of individual and social harmony. Intuitive understanding of harmony leaves infinite its specific interpretation: everyone interprets it as he/she likes, in his/her own way, unlike all the others. This prevents spiritual unity of people in knowledge and use of harmony and this practically nullifies the social importance of intuitive harmony, making it weak in comparison with the powerful organizational forms of negative and destructive forces of disharmony. Intuitive sociology as a spiritual harmony loses in power and its social impact to these forces of disharmony, which remain for it as invincible within millennia.
3. The basic methods of intuitive knowledge of harmony in BK are induction and analogy, based on endless examples. They, very often, are bright, wise and persuasive, showing dignity of the intuitive ideas. These examples make the most difficult thought accessible to the very unpretentious mind. This is the methodological dignity of intuition, which we must adopt. At the same time it is its lack of logic from which we want to free.
4. Intuitive knowledge of harmony is devoid of quantitative aspects and mathematical approaches. Its scientific knowledge, in contrast, has broad mathematical approaches that are presented in *the ABC of Harmony*. As we know, only mathematics transforms knowledge into science, making this knowledge, by conclusive, verifiable, universal concepts, acceptable as one for all. Mathematics lifts this knowledge over an infinite variety of subjective intuitive opinions.
5. The BK, as an organization of intuitive harmony and sociology which exists among the many spiritual organizations in India, develops intuitive knowledge of harmony and submits its infinite spiritual variety, the richest in the world. Nowhere in the world have we found similar spiritual wealth. This is a vivid testimony of the real advantages and power of intuitive knowledge of spiritual harmony at all levels, from the social to the individual and the divine. But the striking and the other, negative, side: these organizations exist independently of each other, not trying to find a harmonious unity among themselves to demonstrate spiritual and organizational harmony in mutual relations. Such harmony in unity could be a much strengthened social influence of spiritual harmony and its many organizations both in India and globally. The unity of spiritual organizations in India would provide the country world leadership in spiritual and interfaith harmony. However, these organizations, including BK, remain in the power of industrial law of the parts rule, not the whole, and are powerless to overcome it. So, unfortunately, the harmonious union of these organizations does not happen and we do not see even the desire for it as if a social need did not exist in it. Why?

On the basis of a brief analysis of the BK intuitive idea of social harmony, we showed its insufficiency, from which the logical necessity of its synthesis with the scientific knowledge of social harmony, especially with *the ABC of Harmony*, follows. The intuition of harmony can overcome its social weakness only by integrating with the science of harmony, which is represented at its highest development in the GHA collective global textbook: *the ABC of Harmony*.

### **The necessity and sufficiency of the unity of science and intuition**

The variety of harmony requires unity of diversity of its knowledge, above all the unity of science intuition. Harmony diversity is represented in its intuition, but the unity of this diversity cannot be achieved beyond that of science. Therefore, unity of harmony intuitions is possible only on the basis of common scientific understanding of harmony presented in *the ABC of Harmony*. This unity is necessary in equal measure for both knowledge of harmony: for intuition, and for science. Only in this unity can necessity acquire sufficiency in mutual complement.

Complementarity, integration and synthesis of science and intuition are the highest level of their cognitive harmony and integrity, and these are adequate to objective integrity of harmony. Their synthesis transforms from possibility into a social need and necessity, along with the sprouts of a harmonious civilization in the early 21<sup>st</sup> century. Science and intuition of harmony must combine their strengths and overcome their weaknesses and limitations in harmonious as internal unity in this civilization to ensure its full knowledge of harmony in its various forms. Only on the basis of this integral knowledge will this civilization be able to develop itself deliberately, nonviolently, freely and the most effectively as for society and nature in a whole as and for each individual.

Full and sustainable interfaith harmony also is achievable only through harmonious unity of science (reason) and intuition (faith).

### **Intuitive and scientific spiritual harmony**

Two types of knowledge of harmony are two kinds of its spirituality: (1) the scientific spirituality of harmony, which was first launched in *the ABC of Harmony* and (2) intuitive spirituality of harmony detailed in the BK texts and others. The necessary and sufficient unity of these two forms of spirituality requires the integration and cooperation of relevant organizations - GHA and BK, in which they develop. GHA recognizes the social necessity of unity for the two forms of spirituality, and also the cooperation and integration of our organizations. We have already mentioned the first offer of our cooperation. After it, we have formulated also two offers of cooperation in the GHA projects:

1. In the project of a new global civil movement: Peace and Disarmament from Harmony on *the ABC of Harmony* Base ([www.peacefromharmony.org/?cat=en\\_c&key=539](http://www.peacefromharmony.org/?cat=en_c&key=539)), which was directed by the BK leaders and delivered personally during the retreat to Administrative Head Dadi Janki
2. In the project "Interfaith Harmony" on *the ABC of Harmony* basis within the Week of Interfaith Harmony established by the UN: [www.peacefromharmony.org/?cat=en\\_c&key=541](http://www.peacefromharmony.org/?cat=en_c&key=541).

GHA offers to discuss closer cooperation between religious organizations, especially the Parliament of World Religions and the GHA, as a representative of the scientific spiritual harmony. Such cooperation is a necessary condition for a stable and full world interfaith harmony in the 21<sup>st</sup> century on the two spiritual foundations: intuitive and scientific.

**Leo Semashko**, PhD, Orthodox faith,  
Philosopher and sociologist; Global Harmony Association (GHA) Founder and President since 2005. Editor in Chief, *The ABC of Harmony*: [www.peacefromharmony.org/?cat=en\\_c&key=478](http://www.peacefromharmony.org/?cat=en_c&key=478).  
**Address:** Saint-Petersburg, Russia  
**Web:** [www.peacefromharmony.org](http://www.peacefromharmony.org)  
**E-mail:** [leo.semashko@gmail.com](mailto:leo.semashko@gmail.com)  
December 20, 2012

Kurt Johnson and David R. Ord

## Interfaith Harmony as Interspiritual Harmony in the 21<sup>st</sup> Century

In a forthcoming book *The Coming Interspiritual Age* [1], we offer a responsible survey of the global factors that might influence and contribute to the possible emergence of world change based on a significant input from the reservoir of collective human wisdom available in the world's perennial Great Wisdom Traditions. Absent such a contribution, the world appears destined to march toward globalization led by self-serving special interest groups, political and financial institutions, leaving the public at the mercy of uncoordinated planetary resource exploitation and consumerism, coupled with a cacophony of competitions and conflicts over politics, financial wealth, natural resources, and the various other currencies of international power.

Specifically, we inquire into a potentially constructive role for religion and spirituality in the world's future, while also noting possible negative roles that should be identified and, if possible, circumvented. Is the future role of religion basically an impotent one, represented only as multiple organized religions' differing creeds and dogmas across the planet's various conflicting, complex, and competing cultures? Or is there an inherent role for spirituality and religion from the innate reservoir of human wisdom that forms the underpinning of our species' millennial history — albeit obscured by a plethora of social and cultural factors? This is a reasonable and important question to ask.

Foreseeing the possibility of a coming “Interspiritual Age” joins a host of other global human visions that hope for a brighter future for our planet — be it from courageously upbeat and optimistic leaders of the environmental, economic-technological, or social justice sectors of our global society. This particular visioning of an emerging Interspiritual Age has arisen from the world's religious, spiritual, and philosophical traditions, anchored in the foresight of a host of historical visionaries across the millennial wisdom traditions who have forecast such a possibility — specifically in the last centuries, pioneers such the West's Teilhard de Chardin and the East's Sri Aurobindo and The Mother, and from these and other wellsprings what has evolved into the burgeoning and multifaceted “evolutionary consciousness movement [2].”

The focus of our recent survey has been one part of this evolving consciousness movement, the emerging global “interspiritual vision.” It has arisen internationally, especially in the last two decades from within the contemplative core of the world's many religious traditions [3]. The emergence of the global interspiritual movement is well summarized in the seminal historical work of the late Brother Wayne Teasdale [4], in large part because of his own close association with colleagues and parallel interspiritual pioneers such as the late Fr. Bede Griffiths, Raimundo Panikkar, and Thomas Merton (pioneers of East-West contemplative and mystical dialogue), and Fr. Thomas Keating. Fr. Keating pioneered not only the East-West Centering Prayer Movement but also the more than two decades-long Snowmass Interreligious Initiative. The latter (particularly from its “Eight Points of Agreement”) [5] can be seen as spawning the world's increasingly dynamic interspiritual movement, especially after the works of Teasdale further popularized the concept. Other major contributors to this development were the so-called “post-Vatican II foundationalist theologians,” which, although often forgotten today after their official admonishment by the Vatican in the 1980s [6], discussed in detail for at least a decade



most of the landscape later traversed together by these later mystical and contemplative pioneers of the interspiritual movement. This latter discussion has continued for at least the last two decades, becoming a dynamic and indefatigable East-West dialogue, and now North-South as well.

As we show however, in surveying this history, this spiritual element driven by the contemplative and mystical voices of the world religions cannot itself be understood, or stand alone, without the larger surrounding context of the other progressive visions now common across a number of other fields of human endeavor and culture. Thus our survey (in *The Coming Interspiritual Age*) includes in-depth surveys of the science, sociology, history, consciousness studies and brain-mind developmental threads that are inevitably part of such an international conversation, unfolding as part of the planetary multicultural and globalization process.

A number of conclusions from this survey are self-evident; what is characteristic of them as a whole is the rather obvious conclusion, testifying to the precarious nature of our time, that in terms of a better or worse future for our planet and humanity, it appears it could “go either way.” These factors include:

1) Globalization of planet earth is inevitable; the question is what kind of a globalization it will be and whether it will be devoid of any significant contribution from the Great Wisdom Traditions;

2) Multiculturalism is inevitable; again, the question is what kind of process will unfold and whether it will be a bumpy ride full of competition and conflict (indeed possibly even outright economic and military warfare) or whether a more reasoned dialogue may emerge, mitigating such negative consequences to some degree;

3) Inevitabilities such as these call into question whether four “unifying” or “Archimedean points [7],” historically identified as possibly culturally unifying across the world's religions, still have any promise for leading the world to something like that predicted by Teilhard's and Aurobindo's visions of maturation. Such unifying principles are also envisioned by the perennial Humanist vision of the “global ethical manifold,” Ken Wilber and the integralists' “conveyor belt” to an “Integral Age,” and the vision of the foundationalist theologians and the interreligious vision of an emerging “Interspiritual Age [8].” The four principles include (1) the possibility of a common core to human mystic experience, (2) fundamental teachings held in common by all the world's religions, (3) the shared ethical implications of the teachings of all the great traditions, and (4) the inevitable mutuality across the religions regarding commitment to social and economic justice.

4) Creeds and dogmas, exclusive by nature at a cultural level, still characterize much of the purely religious side of the world's traditions. However, significant movements across the world's spiritual communities — emphasizing the profound mutual recognition among human beings in the realm of “the heart” and the primary understanding of profound similarities across the traditions' understandings of unifying states of higher consciousness, are also moving profoundly to potentially alter this equation. Spiritual emphasis on the experience of “the heart” and states of unitive higher consciousness appear to nurture universally profound life-altering experiences of interconnectedness, mutuality, and “Oneness.” These experiences are reflected in an increasingly expanding worldwide popular literature and media regarding the experience of a global collective or gestalt of “We.”

5) Modern science continues to bring forward major discoveries concerning the unified nature of reality — both at the level of new factual discoveries and also changes in science's methods and philosophies with regard to these. Such discoveries arise from across the physical sciences as well as the biological and cognitive sciences, affecting our understanding of physics, chemistry, cosmology, our anthropological origins, and changes in the structures and assumptions of the philosophy of science itself.

6) New self-evident truths appear to be emerging. The merging rational and analytical mind of the Renaissance and early European enlightenment created a gestalt in which individuals began thinking strongly in terms of their worldviews and life options, not just those of the



privileged or governing elite, and saw the emergence of self-evident truths with regard to the value and rights of individuals. So also today new self-evident truths seem to be arising. But this time they appear to involve the meaning of collectives and the inevitable roles of individual and institutions within collectives and in responsibility to a collective. An aspect of this is the emergence of a sense of self-evident truths or inalienable rights with regard to access to resources. This appears to be behind all the worldwide “springs” — the Arab Spring, the Occupy movement, and the now-emerging Catholic Spring. These appear to be reflections of humankind's ongoing cognitive development, a development (as we trace in *The Coming Interspiritual Age*) in which our human brain-mind is moving toward a gestalt that sees profound interconnectedness, indeed even “oneness” — a unity consciousness.

### **Positive Developments Vie With Newly Invigorated Global Pathologies**

Meantime, however, significant pathologies across our planetary cultures also appear to be increasing. These include religious and cultural fundamentalism of all kinds, a general decline in critical thinking skills across the world's population (fueled by media over simplification, outright distortion, or misinformation purveyed by “pop culture”), and a general “dumbing-down” of the world's educational, informational, and culturally supportive systems. One result is a prevalence of highly individualized and idiosyncratic worldviews, often reflecting oversimplifications, lack of factual knowledge, outright misinformation, or naïvete. Such worldviews are frequently governed by “buzzword” media or pop culture-based views of reality. Thriving on this are political slogans and punditry of all kinds, which have such an effect on world opinion and political direction that it's nearly stunning to see statistics on degrees of the loss of critical thinking skills across the citizenry of many cultures. Indeed, our review of statistics from worldwide polls shows, alarmingly, that the discoveries and knowledge of modern science and the developed cultural or ethical claims of the world religions actually hold little sway with regard to actual public opinion. Rather, based on the factors reviewed above, a large majority of the world's 7.1 billion citizens hold worldviews that aren't factually based, are highly individualized and idiosyncratic at best, or constitute not holding any general worldview at all [9].

Of particular interest in response to this challenge, a new field of science has arisen: “The Cognitive Science of Religion” (CSR), formally associated in 2006 [10], combining the studies of five major academic fields focused on the investigation of religion and spirituality by scientific methods [11]. The perspectives of CSR suggest a real danger for the world's future may be that the human “monkey mind” will become entrained in ways of viewing reality, and functioning within it, that are radically non-fact based and thus lead to public decision making that actually impedes or seriously challenges a successful future for the species. As an aspect of this viewpoint, CSR also clearly distinguishes the phenomenon of religion from that of spirituality. According to CSR, spirituality refers to humans' underlying personal subjective experiences of reality (“contemplative” and “mystical” experiences, for example). These often lead experiencers to profound, life-altering understandings of the nature of reality and their place in it. Historically, however, CSR sees these naturally occurring experiences, which appear to be part of our deepest human nature, as historically changed (in some senses “hijacked”) by the eventualities of organized religious systems. The priority of organized religions is usually not so much the individualized subjective life-changing experience, but the wider sociological phenomenon of organized religions, which naturally have as their currency exclusive beliefs, dogmas, and creeds. CSR sees the arising of religion from spirituality as natural, but often with a pathological paradox, because religion actually has a different social purpose: to conform behavior to various social, cultural, and political norms (and less-to-nothing to do with spiritual experience).

Statistics reflecting the precarious situation of human worldviews on the planet today include some startling general patterns. For instance, some 70% of the earth's population has a non-scientific worldview; and while 85% are at least culturally associated with a particular

religion, only 35% say they are active in the religion or religions of their culture, while 65% claim they don't actually believe in any religion at all [12]. This suggests that the vast majority of the world's 7 billion people really have no specific view of reality. Looking within this general pattern, regionally worldwide, while less than 35% of people actually practice, or are familiar with, the religious tenants or ethical underpinnings of their surrounding culture, fewer than 20% of those not practicing the religion of their home or surrounding community are conversant with the concepts, worldviews, or ethical tenants of any other religion or ethical system [13]. Overall, significant percentages take their worldview from surrounding pop culture.

As an example, in the United States (whose citizenry a recent study ranked 18<sup>th</sup> worldwide in critical thinking skills [14]), 56-70% of individuals polled favored worldviews not based on either science or the religion of their surrounding community [15]. This included 20-40% professing opinions that are contrary to the views of modern science [16] and 60-70% misstating basic scientific or sociological facts or tenants of the religion of their general community [17], despite the fact that 30% of those interviewed had college degrees [18]. Extreme cases like the United States, where Christian fundamentalism has a strong political base, offer other perplexing challenges. Its community of educated scientists accepts the tenants of modern science almost completely (93%) [19]; yet, despite the fact that 99% of Americans have attended school and 30% have college degrees, in political polls only about 13% of Americans accept the idea or implications of biological evolution, while 48% believe that a God created things mostly as they are now sometime in the last 10,000 years — as startling as this may be [20]. Additionally, of that 48% who believe that creation is about 10,000 years old, 95% said that belief in science and “God” aren't compatible [21]. Further problematic to such statistics is the fact that sociological studies correlate strongly religious cultures with less economic productivity [22] and rich-poor social structures [23]. The United States, because of the relative dynamism of young nationhood, is currently an exception to those correlations, though beginning to evidence the trend [24]. Such statistical generalities seem startling, but are nonetheless real and belie the general assumption of many that the world's cumulative religious, ethical, and scientific knowledge actually has a primary influence on what world citizens believe.

However, there are nuances to this landscape that are important, particularly as to predicting whether our planetary future may be a good one or rocky indeed. First of all, for all the negative implications of the studies above, there are differences when questions aren't asked in language laced with strong religious or political implications. One obtains quite different results when questions are asked at the level of greater generalities — as with hopes, values, or questions about basic principles, especially people's sense of unifying principles, concerning life and reality. Into this conversation come the nearly 30-40% of people worldwide who refer to themselves with the category “spiritual but not religious [25].” For instance, of the world's 7.1 billion citizens, fully 6.1 billion profess a belief that a “spiritual dimension,” even a “spirit realm,” is a part of their life experience [26]. A surprising 78% of those polled internationally believe there are “unifying principles” concerning reality [27]. A number of polls indicate that from 71-80% believe that multicultural understanding is fundamental to a positive world future and that the world should be pursuing a unified vision [28]. Some 80% also believe that the religions should be talking to each other with regard to visions of the common good [29].

### **Although Religion Can Be Problematic, Spirituality is “Wired” in Our Nature**

Along with the 30-40% of individuals who identify themselves as “spiritual but not religious,” some 50% identify religious fundamentalism as a danger [30] and up to 78% describe positive experiences when either personally investigating or interacting with a religion different from their own [31]. Some 40% identify regular practices in their lives that have a background in a religion other than that of their direct heritage [32]. Reflecting the 78% worldwide who believe reality has unifying principles and 77% that there is a positive purpose to history [33], a wealth of scientific and psychological research also underpins the general understanding that subjective experience (indeed, spiritual experience) is fundamental to the makeup of our species. It also

appears there is a clear trend toward the day-to-day spirituality of world citizens becoming more trans-traditional. So, what becomes of this innate tendency, and this trend, relative to our future? Obviously the entire cultural context for spirituality and religion is changing, which means that religion and spirituality will inevitably change. We are apparently at a crossroads.

At a 2012 meeting of the 20-some year old Snowmass Interreligious Initiatives (out of which emerged, by 1986, the “Eight Points of Agreement” further elaborated in Brother Wayne Teasdale’s foundational writing for the worldwide interspiritual movement), Fr. Thomas Keating summarized the world process as follows. The original question of the Snowmass Interreligious Initiative was to ask whether the great traditions have things in common that might anchor their role in positive world transformation. This was the 20<sup>th</sup> century question. The answer, Keating said, is an overwhelming “Yes.” Now, he said, as we enter this next phase — the 21<sup>st</sup> century phase — the business of the planet’s religious and spiritual communities is to begin processing and development around these transformational elements of unity. Moreover, it’s clear that these “Eight Points of Agreement” reflect both the four unifying principles (or Archimedean points) identified by previous historical religious and scientific discussion and the ethical generalities of the “Nine Elements of a Universal Spirituality” [34] embraced by both interspirituality and the foundational documents of humanism [35].

Immediately relevant to this unfolding are the existential encounters of people around the world from across the religious traditions, both in our evolving multicultural civil society and in countless interreligious settings specifically designed to foster innate heart-learning from such associations. In world civil society, it’s already apparent that the sense of boundaries is rapidly fading. It’s obvious in international cross-border, trade, and other cultural settings, but particularly across the landscape of the personal lives of world citizens. Boundaries — national, ethnic, racial, and sexual identity — are all evaporating. Throughout Europe and America, 25% of marriages are now across religions and cultures (a statistic that in highly cosmopolitan locations worldwide can reach 60%), reflecting global statistics that 60% of individuals have also dated someone from another religion or culture [36]. Worldwide, 78% of people report a positive experience of someone from another religion or culture encountered in their work environment [37]. Another certain reflection of this breaking down of boundaries, and the arising of new assumptions about the meaning of collectives and the responsibility of institutions to collectives, are the many “springs” erupting worldwide — Arab, Occupy, and Catholic to name the most obvious. The internet, global entertainment, and travel all make the world today a cosmopolitan community. We see powerful “circles of empathy” arising across professional and social media, actively decrying abuse and crimes against humanity whenever these are witnessed. In the last few years, the power of these social networks has profoundly changed political and civil landscapes in many parts of the world.

In the spiritual and religious context, the encounter today is precisely the “interspiritual encounter” described by Brother Wayne Teasdale in his now classic book *The Mystic Heart: Discovering a Universal Spirituality in the World’s Religions*. It’s becoming, organically — and by what Bro. Teasdale identified as a “new set of historical circumstances” — a currency of “people to people spirituality,” as His Holiness the Dalai Lama calls it. In countless venues around the world, it’s already reflected in the fact of adherents of the world’s varied religious heritages intermixing and, particularly, meeting in settings where they can share not only their deepest subjective experiences but also what these universally imply for how people should live with one another and treat one another. It’s also occurring within traditions, with new emphasis on the meaning of actually realizing spiritual, moral, and ethical maturity, and the meaning of skillful, loving community. In any tradition, such spiritual maturity and the ideals of “interspirituality” are virtually synonymous. These kinds of “interspirituality” have become a reality worldwide.

What empowers this kind of encounter is a grounding in a very realistic and ordinary notion. It recognizes that it’s unlikely the religions of the world will ever sit down and agree on a common set of declarations, ideas, or beliefs. So it turns somewhere else — the profound

possibility that they will simply be able to sit down with each other in this depth of “shared recognition” in the heart. In the long run, nothing less than an experiential, indeed existential, recognition of this kind will serve the ultimate need of our species as it struggles to meet the anthropological threshold presented by a globalizing and multicultural world made up of such diverse and differing components. Absent such a solution, we likely face a future of competition and conflict in which an array of exclusive religious worldviews would play a major part.

### **If This Is the Diagnosis, What's the Prescription?**

The kind of encounter recognized above has a number of components that themselves characterize a spirituality for the 21<sup>st</sup> century — especially if it is to be successful in serving the survival, let alone the thriving, of our species. Its central component must be about the experience available to all people in the existential encounter with “now” — that is, the innate experience of what is, in any moment, “right here, right now.” Art, music, dance, myth, narratives held to be sacred — indeed the experience of human love itself — are universally captured and characterized in this encounter. Such experiences permeate our most ordinary and deepest collective icons — sunsets, walking on a beach or in a forest, looking at the stars, hearing the sound of wind or birds, and touching or embracing. Inarguably, the most satisfying experience recorded across all traditions, and without any religious or spiritual context at all, is what is experienced existentially as “now” — without reference to past or collective hurt, division, or suffering. Millions of people in the world today have experienced, and deeply value, this encounter in “the now.” Eckhart Tolle’s *The Power of Now*, with its multimillion sales worldwide and translation into 33 languages, is only one example of the evidence for this.

However, as Brother Teasdale emphasized in his work, the equally crucial challenge for a 21<sup>st</sup> century spirituality is to address, through a multitude of healing processes — encounter and social remedy — these accumulated hurts, traumas, and divisions that have come from our shared millennial and global history. As psychologists readily note, much of the perennially ingrained fear and hatred that permeates so many sectors of our world is a global post-traumatic stress syndrome, whose severity and complexity must be recognized as such.

The world’s religions in the 21<sup>st</sup> century can serve this process not only by cultivating the individual’s existential and person-to-person encounter, but also by initiating a renaissance in the traditions, calling their adherents back to the depths and riches of our contemplative, mystical core, which is foundational in every human. The mystical — is actual, personal, and potent experience of higher holistic consciousness, and its profound effect of the empowerment of the heart — is essential to a humanity that must turn its collective narrative in a new direction. Further, this must be accompanied by the religions of the 21<sup>st</sup> century emphasizing not their differences, nor their exclusive claims, but the shared collective views of oneness and profound interconnectedness — with all their ethical implications — that characterize the heart of all the world’s Great Wisdom Traditions. If, from evolutionary history, our human nature is prone to following sloganeering, punditry, or emotionally compelling narratives, we — as Bertrand Russell proclaimed — might as well tell a good story instead of a poor one.

The call for holistic, heart-based religion and spirituality — for a world with rapidly dissolving boundaries — is no easy prescription. Brother Teasdale, addressing the religion of his own personal heritage, noted it would take great courage for any of the world’s religions to accept this universal and holistic task, then work to have it replace the tendencies to exclusivism so ingrained and embedded in our anthropological nature. Barely three centuries ago, humanity emerged from seventy centuries of monolithic social and religious structures, all perennially nurtured by an era wherein societies, peoples, and languages were geographically separate and thus innately insular. As the work of anthropologists and developmental historians clearly illustrates, nearly every world upheaval through our millennial history has come on the heels of the breaking down of boundaries. In the past in such circumstances, our species *Homo sapiens* proved to be the “great adapter.” This is what assured our becoming, among all the intelligent hominid species that have come and gone on the planet (and there have been at least fifteen),

what modern science calls “the last man standing.” It’s a big question whether, at this juncture in our history, our adaptive pluck — and luck — might run out. Seventy thousand years ago, there were three intelligent species on the planet: *Homo sapiens*, *neanderthalensis*, and *floresiensis*. Luck ran out for the last two.

Our view, in light of current scientific consciousness and brain-mind studies, is that the human mind is entering a new gestalt, less dual, and more innately seeing a profoundly interconnected reality. In this context, strikingly upon us as we simultaneously enter a new millennium, arises the challenge of a 21<sup>st</sup> century spirituality. It must center on the clear implications and challenges of an inevitable globalization and multiculturalism. It must emphasize and mine our shared subjective (yes, mystical) nature. And it must empower and expand our already existing narratives of Oneness, profound interconnectedness, and the possibilities of welcoming person-to-person encounter across traditional boundaries.

In this millennium, it’s likely we will enter a challenging period of experimentation. Just as when the modern analytical mind began emerging in the Renaissance and, moving into the early centuries of human intellectual enlightenment, displaced seven millennia of monarchy with new visions of “freedom,” our new millennium may see decades, perhaps centuries, of experimentation. This experimentation will be about what our hard-won understanding of the dignity of the individual now means in light of the urgent need for an awakened and skilled global collective. It’s a profound question as to what part, if any, religion and spirituality will step up to play in this chapter of our evolution.

Many feel that if “old time” exclusive religion doesn’t evolve into a holistic gestalt — capable of skillfully operating in a complex global and multicultural world — it will, as in the cliché “part of the problem and not part of the solution,” be destined for extinction. Like astrology before it (which ruled for centuries in the Middle Ages), it might simply fade away; or it may be part of a world cataclysm of conflict that ends up bringing the planet down. Having said this, humankind’s spiritual nature appears fundamental; hence it’s this part of our makeup that would change, and with it the structures of religion. The coming Interspiritual Age would characterize the arising 21<sup>st</sup> century spirituality, as we have outlined above: highly personal, highly experiential, holistic, and all embracing. It’s likely its narratives would no longer be anthropomorphic — those of casts of celestial characters bringing permanent salvation or damnation. Its narratives would more likely be about how reality is structured and how it works, in both our inner and outer cosmologies. Most of all it would teach a world of the heart, where “truth” is identified with what brings everything and everyone together, and “falsehood” identified with whatever separates or parts.

The world is already full of models that reflect these kinds of visions and values. It isn’t overreaching to forecast that this kind of spirituality, and religion, must characterize the 21<sup>st</sup> century. Interspiritualists and interreligionists call it “the Interspiritual Age.” Integralists and developmentalists refer to it as “the Integral Age” or “Age of Evolutionary Consciousness.” Humanists speak of it as “the Ethical Manifold.” We agree with those who think this is the direction we are going — the undeniable trend. A key role in it belongs to the global harmonious education through the world textbooks as *the ABC of Harmony* [38], *The Coming Interspiritual Age* [1] and the like.

#### Abbreviated Endnotes

[1] Hereafter “TCIA”, Namaste Publishing, 2012; [2] [3] for specific lists see TCIA; [4] *The Mystic Heart* 1999, *A Monk in the World* 2003, *Bede Griffiths* 2003; [5] Miles-Yepez [ed], *The Common Heart* 2004; [6] Vatican “CDF” statements 1984, 1986; [7] scientific term, see *Time’s Arrow and Archimedes Point* 1996; [8] Felix Adler *Life and Destiny* 1903, *Reconstruction of the Spiritual Ideal* 1923, Ken Wilber *Integral Spirituality* 2006; [9] reviewed hereafter are poll results on a subject by subject basis; [10] Int. Assoc. for the Cognitive Science of Religion; [11] sociobiology, sociology of religion, anthropology of religion and transpersonal and evolutionary psychology; [12] Gallup 2011; [13] *NY Times* 2010; [14] Reuters 2011; [15]

Roper 1999, 2002; [16] Gallup 2011; [17] Roper 1999, 2002; [18] *USAToday* 2010; [19] [20] Gallup 2007; [21] [skepticsociety.org](http://skepticsociety.org); [22] Gallup 2007; [23] [24] *NY Times* 2010; [25] Gallup 2002; [26] [adherents.com](http://adherents.com); [27] Pew 2007; [28] FT & Harris 2007, Yankelovich & Pew 1998, 1999; [29] PRRI/RNS Religion News 2011; [30] Gallup, Pew 2005, 2007; [31] Interfaith Alliance 2009; [32] ABC 2011; [33] Yahoo UK, 2009; [34] *The Mystic Heart*; [35] see 8; [36] Global Social Survey 2006; [37] Interfaith Alliance 2009; [38] [www.peacefromharmony.org/?cat=en\\_c&key=478](http://www.peacefromharmony.org/?cat=en_c&key=478).

**Rev. PhD. Kurt Johnson**, Multifaith,  
Vice-president, GHA-USA  
New York City's One Spirit Interfaith Seminary.  
**Address:** New York, USA

**Web:** [www.isdna.org](http://www.isdna.org), [www.onespiritinterfaith.org](http://www.onespiritinterfaith.org), [www.thecominginterspiritualage.com](http://www.thecominginterspiritualage.com),  
[www.peacefromharmony.org/?cat=en\\_c&key=554](http://www.peacefromharmony.org/?cat=en_c&key=554),  
[www.peacefromharmony.org/?cat=en\\_c&key=554](http://www.peacefromharmony.org/?cat=en_c&key=554)

**E-mail:** [kurtjohnsonisd@yahoo.com](mailto:kurtjohnsonisd@yahoo.com)

**Phone:** 347-663-4732

**David Robert Ord**. Multifaith. He is editorial director of Namaste Publishing, a multifaith practitioner who is a former Presbyterian (USA) minister and a graduate of San Francisco Theological Seminary. Most recently he is co-author, with Dr. Kurt Johnson, of the very popular book *The Coming Interspiritual Age*. He is also co-author with Dr. Robert B. Coote of *The Bible's First History — From Eden to the Court of David with the Yahwist; In the Beginning — Creation, Priestly History; Is the Bible True?; and Understanding the Bible Today*. With Namaste Publishing he has also authored *Your Forgotten Self: Mirrored in Jesus the Christ*.

**Address:** Phoenix, USA

**Web:** [www.namastepublishing.com](http://www.namastepublishing.com)

20/02/13

Robert D. Crane

## Global Awakening: Toward the Interfaith Harmony of Global Ethics

Two years after the beginning of the so-called Arab Spring, we are in a new era. Some people call it simply the Post-Arab Spring. Some call it the Arab Winter. The Chinese written language has a single character perhaps better suited to reflect the prospects of a new era. This character has two meanings. The first is “crisis”. The second meaning is “opportunity”.

Ever since the time of the first cavemen millions of years ago we humans have tried and failed to balance two opposing approaches or paradigms of thought. One is based on what one might call the “threat mentality”. We find this among military strategists, whose job is to prepare for the worst and focus only on the “bad guys”. The other premise for action is the “opportunity mentality”, which goes beyond mere tolerance to seek interfaith harmony within the diversity of a pluralist world. This is the highest calling of the ambassadors of good will who gathered on February 26<sup>th</sup>, 2013, in Kuala Lumpur at the Ambassadors Conclave of the International Seminar on Interfaith Harmony and Tolerance in cooperation with the International Islamic University Malaysia (IIUM), Malaysia's Prime Minister's Office and the Ma'din Academy of India.

In 1981, when President Ronald Reagan asked me to be the U.S. Ambassador to Shaykh Zayed bin Nahyan of the United Arab Emirates, my first initiative was to write an essay of guidance entitled “The Diplomacy of the Prophet”.



The models for Muslims and for the world were the first two ambassadors of Islam. The first was Mus'ab ibn 'Umair, who migrated to Abyssinia with other followers of the Prophet Muhammad, *salah Allahu 'alayhi wa salam*, in order to assure that at least some Muslims would survive the persecution by the Quraysh. Mus'ab then was appointed as ambassador to Madinah (Yathrib) and prepared ten thousand people there as Ansar to welcome the Muslims from Makkah on the Day of Hijra.

The second Muslim ambassador, and by far the most famous one, was Mu'adh ibn Jabal, who was recruited by Mus'ab ibn 'Umair. When Makkah was peacefully liberated, the Prophet appointed Mu'adh to teach the people the message of Islam. Sometime after the Prophet had returned to Madinah, messengers came to him from the kings of Yemen, who ruled three different nations, one Jewish, one Christian, and one Zoroastrian. They welcomed him and requested that he send an ambassador to develop good relations. For many years thereafter four nations, including one ruled by Muslims, lived in harmony during an era of what at the time was chaos throughout the entire world.

The Prophet appointed Mu'adh as the Emir of a delegation to explain the teachings of Islam to these four nations. He then tested Mu'adh by asking him: "When you teach, according to what will you judge?" "According to the Book of God," replied Mu'adh. "And if you find nothing there?" "Then according to the Sunnah of the Prophet of God", he replied. "And if you find nothing in it?" "Then I will use my own reason (exercise *ijtihad*) to form my own judgment." The Prophet was pleased with this reply and said: "Praise be to God Who has guided the messenger of the Prophet to that which pleases the Prophet."

This was the formal foundation of Islamic normative jurisprudence, which later became known as the *maqasid al shari'ah*, as distinct from the specific rulings, today known as the *fiqh*. At the Second Parliament of the World Religions in Chicago in 1993 perhaps the greatest Christian theologian of the 20<sup>th</sup> century, Hans Kung, applied a more universally acceptable name for this concept of normative law. He called it "global ethics". In 2005, Prince Ghazi bin Muhammad of Jordan, head of the Royal Islamic Strategic Studies Center, built on this to lead a movement known as the Common Word, and in 2010, the Dalai Lama attempted to build on this still further by initiating a movement known as Common Ground.

This jurisprudential branch of knowledge has always existed in human history but it originated among Muslims in the practice of the Prophet Muhammad to gather together his most gifted followers and put to them both hypothetical and real cases for judgment. After each had given his judgment, the Prophet said, "Your conclusions are good, but I want to know what principles you used in reaching them".

According to Shaykh Taha Jaber al Alwani, who today is a member of the World Fiqh Council in Makkah, the Prophet's nephew, Ali ibn Abi Talib, and Mu'adh always reasoned from basic principles inherent in the *nazm* or coherence of the Qur'anic message. These two were the best in developing the normative jurisprudence of what today we call human responsibilities and human rights.

The universal key to seeking the best in life by honoring our responsibilities and rights is the Islamic concept of *infaq*, which is the inclination to give rather than to take in life. This is part of human nature or *fitra*, though it has to be educated in order to overcome the contrary impulses to take rather than to give. Our common task as *khulafa* or stewards of creation in the search for transcendent harmony both within and among civilizations is to honor the wisdom found in Surah al An'am 116, *tama'at kalimatu rabika sidqan wa 'adlan*, "The Word of Your Lord is fulfilled and completed in truth and justice".

This raises several questions. We know that there is such a thing as absolute truth, which is our lifelong responsibility as sentient beings to seek as best we can. But what is justice? Can it originate universally from the *Sunnat Allah* through the three sources of *haqq al yaqin* or divine revelation, *'ain al yaqin* or scientific observation of the laws of the universe, including human nature, and *'ilm al yaqin* or the use of intellectual effort to understand the first two sources? Can it be partially informed even by individual inspiration or *ilham* through the descent

of the intellect from the transcendent to the *nafs al mutma'ina* or enlightened soul and on through the irreducible principles of human responsibilities and rights to the level of application and practice in the specifics of the *fiqh*? Can the Islamic message thereby originate in love for application through the human will in a circular process of harmony, whereby the intellect and the will inform each other, as proposed in the second Islamic century perhaps for the first time by Imam Jafar al Siddiq?

In short, can there be such a thing as global ethics, as recommended in my book, *Rehabilitating the Role of Religion in the World through Global Ethics*, first published electronically in my de facto blog, [www.theamericanmuslim.org](http://www.theamericanmuslim.org), in May and June 2009, and in my book, first published in the same e-zine in 2007 and in print three years later as *The Natural Law of Compassionate Justice: An Islamic Perspective*? Is this what the President of the International Court of Justice (ICJ), Hisashi Owada, is advocating in his monograph published as an Occasional Paper, Series 4, March 2012, in London by The Cordoba Foundation under the title, *Evolving World: The Universality of International Law in a Globalizing World*?

Justice through global ethics is the awareness and practice of human rights, which are the result of respecting the corresponding human responsibilities. All human rights are interdependent and mutually supporting. The most basic human right is the right to be oneself, which refers to the spiritual dimension and can be understood as freedom of religion, known as *haqq al din*. This is related to *haqq al nafs*, which is respect for the human person as sacred, and *haqq al nasl*, which is respect for the human family and for communities all the way up to the nation because they are composed of persons. A fourth related right is *haqq al mahid*, which is respect for the physical environment as sacred.

These four guiding principles require four implementing principles. The first is *haqq al mal*, which is respect for private property, especially individual ownership of the means of production. At a secondary level this requires a system of banking, credit, and taxation that broadens access to ownership of productive wealth as essential for economic self-determination. A product of this basic right is political self-determination or political freedom, *haqq al hurriyah*, based on acknowledgement that economic power is the key to political power. The last of the four implementing principles are *haqq al karama*, which is respect for human dignity, including gender equity, and *haqq al 'ilm*, which is respect for the right to free speech and free assembly.

These are the eight basic human responsibilities and associated human rights in classical Islamic jurisprudence, though the greatest scholars taught that the exact number of essential human rights and the architectonics of their implementation may change contextually according to time and place.

The overriding requirement is that they remain in harmony, because they are all interdependent. In Islamic philosophy this requirement is known as *tawhid*, which is the coherence of the diversity in creation that points to the oneness of the Creator.

In practice *tawhid* informs the higher guidance that should guide the understanding and applicability of the *fiqh* or rules and regulations as spelled out by two of the greatest Islamic scholars, Shamsuddinibn al-Qayyim (who died in 748 A.H., 1347 A.C.) and his mentor Imam Ahmad ibn Taymiyah (d. 728). Ibn Qayyim wrote: "The Islamic law is all about wisdom and achieving people's welfare in this life and the afterlife. It is all about justice, mercy, wisdom, and good. Thus any ruling that replaces justice with injustice, mercy with its opposite, common good with mischief, or wisdom with nonsense, is a ruling that does not belong to the Islamic law."

At the highest level applicable to the universal jurisprudence of global ethics, *tawhid* consists of three basic premises.

The first is its holistic ontology, according to which the entire created order exists in unitary harmony. The things and forces we can observe are real, but their existence comes from God. They do not exist independently of His purpose.

The second premise is esthetic. The nature of transcendent reality, and of all being, is Beauty, which precedes and is independent of cognition. The flower in the desert is beautiful

even if no person sees it. Beauty, and necessarily therefore the normative law of global ethics consists of unity, symmetry, harmony, depth of meaning, and breadth of applicability. The greatest beauty is the initial principle of *tawhid* itself, because without it there could be no science and no human thought at all. This is of controlling importance, because it means that the ideal system of law should be simple, symmetrical, deep, and comprehensive.

The third premise is epistemological. All knowledge is merely a derivative and an affirmation of the unitary harmony inherent in everything that comes from God. All creation worships God because He is One. Every person is created with a need and a corresponding intuitive capability to seek and to know transcendent reality and to submit lovingly to God in thought and action. This epistemological premise reinforces the first two, because it indicates that Islamic jurisprudence as part of a new era of global ethics exists to give meaning to everything man can observe. And meaning comes from God, Who gives purpose to everything He has created.

Regardless of the school of thought one may follow, the discussion of the universal human responsibilities and rights culminates in what is the essence of *tawhid* and of every world religion. This is the harmony of truth, love, and justice. The Schools of Interfaith Harmony, based on *the ABC of Harmony* ([www.peacefromharmony.org/?cat=en\\_c&key=478](http://www.peacefromharmony.org/?cat=en_c&key=478)) and similar global textbooks, which are suggested in this GHA project is a key way scientifically to unfold the universal values of truth, love and justice from harmony for new generations of our planet. Their harmonious consciousness will be the most fundamental basis for world peace.

The highest calling for all of us in the quest for truth, love, and justice is to recognize that charity is essential in both intent and practice, but the pursuit of justice through interfaith harmony and cooperation is equally essential in order to actualize for everyone the basic human rights of peace, prosperity, and freedom.

**Dr. Robert D. Crane**, Muslim,  
GHA Vice-President,  
Full Professor - Center of the Study of Contemporary Muslim Societies  
Qatar Faculty of Islamic Studies  
Hamad Bin Khalifa University  
**Address:** P.O Box: 34110 Doha, Qatar  
**Tel:** +974 445 42822 **Fax:** +974 445 46620 **Mob:** +97466766013  
**E-mail:** [rccrane@qfis.edu.qa](mailto:rccrane@qfis.edu.qa)  
**Web:** [www.qfis.edu.qa](http://www.qfis.edu.qa)  
21/02/13

## 6. Alphabet of Social Harmony, Acceptable to All Faiths and Ensuring their Harmony

**The shortest definition of the alphabet of harmony:** It is the 20 fundamental, necessary, sufficient and coherent elements/spheres of society that express the deepest structure of social harmony and define the infinite variety of its manifestations. These 20 elements create the alphabet of harmony, its social code. It is defined by an axiom of social harmony.

**Axiom of Social Harmony:** *The harmonious existence of a society in any place and at any time is defined by four necessary and sufficient resources:*

- **People (P),**
- **Information (I),**
- **Organizations (O) and**
- **Things (T).** *(Things are any material benefits and services).*

These resources are expressed in the chain: People (P) – Information (I) – Organization (O) – Things (T) or in the acronym: P-I-O-T, or: PIOT.

**Five Clusters of Harmony Elements.** *The ABC of Harmony* consists of five necessary, sufficient and coherent groups/clusters of the fundamental elements of social harmony: **resources – processes – structures – classes – individual/human.**

PIOT's basic resources are in a closed cycle of the **processes** from their production, where they arise, through their distribution and exchange to consumption, where they disappear. Four processes are: production, distribution, exchange and consumption (PDEC).

PIOT resources, together with their closed processes, create the **structures/organizations** or **spheres** of their production and consumption. Four spheres are: social, informational, organizational and technical (material or economical) (SIOT).

The people employed in these structures comprise the large groups of the population and make the relevant **spherical classes** and **spherical social structure** of any society. Four spherical classes are: social, informational, organizational and technical (SIOT-classes).

PIOT resources, as a social macrocosm, are impressed in microcosm of the **individual/human** as its internal similar complex of spherical resources, defining his/her life and harmony. Four personal spheres/resources are: character, consciousness, will and body (CCWB).

All the infinite variety of objects, structures, properties and relations of the social world are summarized in these five clusters and reduced to it. Therefore, the ABC, which includes them, is universal for the social world. The ABC embraces its diversity, which aspires to harmony as a sustainable development of this world and the most optimal state of it.

The clusters of harmony elements are inseparable, interrelated and coordinated, resulting in a notion of coherence. Ontologically, epistemologically and dialectically, the harmony and all clusters of its elements are coherent, i.e. they agree in their inseparable interrelation, which creates integrity/wholeness of any social harmony on any level.

A more detailed Alphabet of social harmony, equally acceptable to all nations and religions, is presented in Appendix 1 of the project (see below).

## 7. Way of Interfaith Harmony: Harmonious Education through Interfaith Harmony Schools on *the ABC of Harmony* Basis

The GHA created in 8 years the nine educational projects based on *the ABC of Harmony* and its alphabet. GHA projects dedicated to harmonious education are:

1. Academy of Harmony and General Harmonious Education, 2008:  
[www.peacefromharmony.org/?cat=en\\_c&key=392](http://www.peacefromharmony.org/?cat=en_c&key=392)
2. Russia-Georgia: Harmonization through Education instead of Militarization, 2008:  
[www.peacefromharmony.org/?cat=en\\_c&key=337](http://www.peacefromharmony.org/?cat=en_c&key=337)
3. Family Academy of Harmony, April 2009:  
[www.peacefromharmony.org/?cat=en\\_c&key=470](http://www.peacefromharmony.org/?cat=en_c&key=470),
4. Youth Academy Harmony, September 2009:  
[www.peacefromharmony.org/?cat=en\\_c&key=395](http://www.peacefromharmony.org/?cat=en_c&key=395)
5. Academy of Harmonious Leadership, May 2010:  
[www.peacefromharmony.org/?cat=en\\_c&key=429c&key=337](http://www.peacefromharmony.org/?cat=en_c&key=429c&key=337)
6. Educational TV project: "The Future: Harmonious Civilization or What?" 2010:  
[www.peacefromharmony.org/?cat=en\\_c&key=447](http://www.peacefromharmony.org/?cat=en_c&key=447)
7. Israel - Palestine: Harmonization through Education instead of Militarization, 2011:  
[www.peacefromharmony.org/?cat=en\\_c&key=454](http://www.peacefromharmony.org/?cat=en_c&key=454)
8. School of Peace through Harmonious Education for Israelis and Palestinians, 2011:  
[www.peacefromharmony.org/?cat=en\\_c&key=461](http://www.peacefromharmony.org/?cat=en_c&key=461)
9. Department of Harmonious Civilization for any University/College of the World, 2011:  
[www.peacefromharmony.org/?cat=en\\_c&key=465](http://www.peacefromharmony.org/?cat=en_c&key=465)

These projects include a wide range of curricula and lectures for schools of different levels. A specific curriculum for any school of interfaith harmony, in any denomination, and in any country can be made from this set. GHA is ready to obey such an order of any congregation from any country, to make the curriculum of the school and to participate in its design and in the preparation of teachers for it, providing it for the first time with the necessary staff of international educators: teachers and professors. A broad international network of interfaith harmony schools will determine the path for interfaith harmony in the 21<sup>st</sup> century through harmonious education based on *the ABC of Harmony* and similar textbooks.

## 8. Curriculum of the Interfaith Harmony Schools. Example: Harmony School in Jerusalem

In 2011, GHA created the project "School of Peace through Harmonious Education for Youth of Israel and Palestine" (SPHE: [www.peacefromharmony.org/?cat=en\\_c&key=461](http://www.peacefromharmony.org/?cat=en_c&key=461)). In essence, it is a project of the Interfaith Harmony School (IHS). This project contains a curriculum that can be the IHS curriculum.

**SPHE Curriculum.** The general goal of SPHE and every teacher in it is: to ensure the formation of the worldview of harmonious peace and its conscious building of associations by the means of each discipline/subject in curriculum. These subjects of harmonious education are divided into two main classes: fundamental and applied. The duration of fundamental disciplines is within 60-120 school hours. The duration of the applied disciplines is within 20-40 school hours.

Within this general goal is allocated a minimum of 22 subjects of the curriculum in SPHE harmonious education and the minimum number of teachers for them:

### **Fundamental disciplines/subjects are:**

- History of social harmony and civil peace: Numa Pompilius and similar historical examples (Charles Mercieca and 2-3 historians)
- Alphabet of social harmony: 20 fundamental elements (Leo Semashko and 2-3 sociologists)
- World philosophy of harmony: European with Pythagoras, Chinese with Confucius, Indian with Vedas, Jewish and Arabic (Leo Semashko, Laj Utreja and 2-3 philosophers)
- Harmony of world religions, especially Judaism and Islam (Rudolf Siebert and 2-3 teachers)
- Theory of a harmonious civilization and its building as applied to the region (Leo Semashko and 2-3 sociologists)
- Statistics of social harmony (Leo Semashko and 2-3 sociologists)
- Culture of harmonious peace, its spiritual values and the theories of eternal peace (Ernesto Kahan, Leo Semashko and 2-3 teachers)
- Mathematics of harmony (Alexey Stakhov and 2-3 mathematicians)
- Hebrew and Arabic languages (4-6 teachers)

### **Applied disciplines/subjects are:**

- Experience of the harmonious intercultural communications in CARE (Ghassan Abdallah and 2-3 teachers)
- Experience of the harmonious interfaith meetings between Jews and Arabs (Yehuda Stolov and 2-3 teachers)
- Experience of the harmonious dialogs between Jews and Arabs in Mepeace (Eyal Raviv and 2-3 teachers)
- Poetry, literature and art of harmony (Ernesto Kahan and 2-3 teachers)
- Linguistic Harmony through Esperanto (Renato Corsetti, Katherine Shabbat and 2-3 teachers)
- Harmonious Civilization Universal Declaration (Leo Semashko and 2-3 teachers)
- Declaration of Religious Harmony in Singapore (Leo Semashko and 2-3 teachers)
- Harmonious leadership and management (Leo Semashko and 2-3 economists)
- Pedagogy and Organization of harmonious education (Leo Semashko and 2-3 teachers)
- Spiritual Activism: the ethics and values of harmony (Nina Meyerhof, and 2-3 teachers)
- Psychology and harmony of the individual (Leo Semashko and 2-3 psychologist)
- Breathing technique as a way to harmonize the individual (Laj Utreja and 2-3 teachers)
- Harmonization of democracy, the State and Law (Leo Semashko and 2-3 jurists)

The shown persons in parentheses are the GHA members, scholars and professors, who can act both as visiting lecturers and as consultants of local teachers. The proposed list of academic disciplines of harmonious education will change in time and space. SPHE Curriculum may vary on the different stages of training from 1 to 5 years depending from the level of

training of students and forms of learning: daytime, evening and correspondence, and also online.

In developing this curriculum and for its dissemination in the media of Israel and Palestine, we could create the TV Program: "Israel - Palestine: The Future – Harmonious Civilization or Eternal War?" on the basis of the corresponding GHA TV project, translated into Hebrew.

#### **SPHE Organization Base: Ghassan Abdallah's CARE and Yehuda Stolov's IEA**

The first training, staffing and student SPHE base are two educational organizations in the region:

1. Ghassan Abdallah's Center for Applied Research in Education (CARE) in East Jerusalem and
2. Yehuda Stolov's Interfaith Encounter Association (IEA) in Jerusalem.

Both organizations have long existed and have wide experience in teaching, education and cultural cooperation between Israelis and Palestinians. Therefore, these organizations can provide a first set of students in SPHE in 40-60 people. Mypeace Organization, uniting thousands of young Israelis and Palestinians can assist in the formation of the required number of students.

These organizations also have many contacts with teachers from both sides and may invite them to teach at SPHE after appropriate training by the GHA professors. These organizations can also provide learning process the required auditoriums at the first stage.

This curriculum could be the basis of the curriculum for any interfaith harmony school. The question now is only in the interest of confessions to similar schools and in the possibilities of financing. To do this, it is advisable to create the UN centralized Foundation and Committee for the organization of these schools. The GHA experience in designing of harmonious education institutions would be valuable and necessary at all stages of the establishment and operation of such Foundation and Committee.

More detailed practical ideas for Schools of Interfaith Harmony are presented below in the GHA offers.



## 9. The GHA Offers to Jordan's King Abdullah II

Below is the GHA Proposals List to the HM King of Jordan Abdullah II as the most worthy and favorable world leader of global harmony, World Harmony Creator (GHA) for he initiated in the UN the world's first conscious action of global harmony in the interfaith world of the 21<sup>st</sup> century and started a conscious movement of religions to global harmony.

1. Initiate the creation of the UN Committee of Interfaith Harmony on the basis of the ABC of Harmony. (GHA can prepare the project draft of this Committee on the basis of this project)

2. Create and lead the International Foundation of Harmonious Enlightenment for construction of Interfaith Harmony School around the world. (GHA can also prepare this project draft).

3. Create in Amman the International Academy of Harmony for training Interfaith Harmony schools teachers. (Project of this Harmony Academy was prepared in GHA: [www.peacefromharmony.org/?cat=en\\_c&key=277](http://www.peacefromharmony.org/?cat=en_c&key=277)).

4. Initiate CLUB-2009: Union of the World Political Leaders to support a harmonious civilization on the basis of inter-faith harmony: [www.peacefromharmony.org/?cat=en\\_c&key=409](http://www.peacefromharmony.org/?cat=en_c&key=409)

5. Publish the GHA Interfaith Harmony project with a foreword by Jordan's King Abdullah II in large numbers (for example in 20,000 copies) in the UN languages: English, French, Spanish, Arabic, Chinese and Russian. Half edition is distributed free among the different faiths in areas of social and religious tensions and conflicts.

6. Create in Amman the International Institute of World Interfaith Harmony on the ABC of Harmony base as a scientific theory of social harmony. GHA can provide this by scientific conception and key staff.

7. Finance the international comparative sociological study of Dynamics of the Spherical Classes of Population as Fundamental Actors of World Interfaith Harmony in 1950-2010 by decades in India, USA, Jordan, and Russia in the 6 months by 10 sociologists with the publication of the final book. Approximate funding is about \$ 100 thousand. Such a study can be conducted in any country of the world under the leadership of GHA sociologists.

8. Organize the Third World Religions Congress "Global Interfaith Harmony Education" on February 1-7, 2015 in Amman, under the UN aegis. It will be logical development of the HM World Interfaith Harmony Week initiative.

9. Initiate in the UN, as a development of your initiative 2010, a proposal of the UN Decade of Interfaith Harmonious Education for 2014-2023, which will strengthen a harmonizing mission of state and religion in global society in a non-violent peacemaking way of qualitative renewal of the education system in the world, especially in the direction of interfaith harmony and harmonious consciousness of nations, instead of militarization. The main purpose of this Decade - to create 10,000 Centers (Schools) of IHE (CIHE, Center of Interfaith Harmonious Education) in the world, each year by 1,000, primarily in the areas of religious tensions: the Middle East, Ireland, Afghanistan, Pakistan, India, Sudan, Mali, etc.

## 10. Appendixes

### Appendix 1

Key content of *the ABC of Harmony* on 12 pages

Dr. Leo Semashko

*The ABC of Harmony* Key Contents on 12 Pages.  
Global Tetrasociology of a Harmonious Civilization in the 21<sup>st</sup> Century

**Abstract:** This paper is devoted to the pluralistic tetrasociological theory of social harmony and harmonious civilization, developed since 1976, which was most fully reflected in the collective book of the author and his 75 co-authors from 26 countries: "*The ABC of Harmony*."

**Key words:** ABC of harmony, social harmony, Tetrasociology, Tetrism, global peace, harmonious civilization, tetranet harmonious thinking

#### **The ABC of Harmony and its Meaning for Sociology and Society**

*The ABC of Harmony for World Peace, Harmonious Civilization and Tetranet Thinking*, Global Textbook, by Dr. Leo Semashko, Project Manager, Editor in chief and GHA 75 coauthors from 26 countries: first is published in English in India, New Delhi, Doosra Mat Prakashan, 2012, 334 pages, ISBN – 978-81-923108-6-2. The book is submitted also in the two electronic formats: [www.peacefromharmony.org/?cat=en\\_c&key=478](http://www.peacefromharmony.org/?cat=en_c&key=478) – HTML and [www.peacefromharmony.org/file/6079/ABC\\_of\\_Harmony\\_eng.pdf](http://www.peacefromharmony.org/file/6079/ABC_of_Harmony_eng.pdf) - PDF.

The authors' 27 reviews are at: [www.peacefromharmony.org/?cat=en\\_c&key=489](http://www.peacefromharmony.org/?cat=en_c&key=489)

The book may be ordered at: [www.peacefromharmony.org/?cat=en\\_c&key=508](http://www.peacefromharmony.org/?cat=en_c&key=508).

*The ABC of Harmony* is represented on all continents in the libraries of hundreds of educational institutions: schools, colleges and universities, as well as at the GHA members and friends in dozens of countries.

*The ABC of Harmony* was prepared within GHA in 2011 and published in early February 2012 in Russian in St. Petersburg and in English in New Delhi, India. Among its 76 co-authors are prominent scientists, peacemakers, artists and politicians: former President of India, Dr. Abdul Kalam; architect of Ronald Reagan's economic reform, Dr. Norman Kurland; head of the international organization of doctors (IPPNW), which received the Nobel Peace Prize in 1985, Prof. Ernesto Kahan; Chancellor of the Pedagogical IASE Deemed Gandhi University, Kanak Mal Dugar; Catholic Professor and the UN agent, Dr. François Houtart; President of World Esperanto Association, Prof. Renato Corsetti; President of International Association of Educators for World Peace, Prof. Charles Mercieca; President of International Forum for Literature and Culture of Peace, Prof. Ada Aharoni; Secretary General of "World Constitution and Parliament" Association, Prof. Glen Martin; prominent Russian Professors: Vladimir Bransky, Gregory Tulchinsky, Alexander Subetto, Dimitry Ivashintsov and many others. Five co-authors have the, GHA highest honorary title: World Harmony Creator as explained at [www.peacefromharmony.org/?cat=en\\_c&key=513](http://www.peacefromharmony.org/?cat=en_c&key=513).

*The ABC of Harmony* is the first in the world and history the global textbook on social harmony for all nations, presidents and the UN. The presentation of this book at the International Seminar of teachers in New Delhi February 11, 2012 marked the beginning of a new era of humanity - the Age of Harmonious Enlightenment and Education, which aims to overcome the total ignorance of the past history in social harmony ([www.peacefromharmony.org/?cat=en\\_c&key=511](http://www.peacefromharmony.org/?cat=en_c&key=511)).

Of course, like all first, *the ABC of Harmony* is far from perfect, it is still in an embryonic state, and as a theory, and as an empirics. But it opens up a fundamentally new way of social

thinking in the 21<sup>st</sup> century. It was the first time an alternative to traditional, private, and partly sociological theories in general, i.e. sociology of industrial civilization, broken into hundreds of branch parts, helpless in the whole scientific picture of outgoing, industrial civilization, and a new, harmonious one.

*The ABC of Harmony* unfolds the global sociology as science of this civilization - Tetrasociology, developing more than 35 years. This science is its necessary spiritual prerequisite, which precedes and is ahead its to light scientific nonviolent conscious development of this civilization. If for spontaneous and because violent industrialism sociology is not required (so it drags like its appendage with a very little use), then harmonism can be born and grow only consciously and scientifically, without that it is impossible in principle as non-violent civilization. By this Tetrasociology is fundamentally different from industrial sociology. Therefore, the prominent American philosopher Prof. Glenn Martin defined the quality of Tetrasociology and its *The ABC of Harmony* as "The fundamental revolution in science and paradigm shift in human consciousness, ... as Our New Planetary Paradigm " [1, p. 296].

This article is a synopsis of Tetrasociology from this ABC with the system using tetramodels as the tools of tetranet harmonious thinking [1, p. 67-79].

### Conscious Nature of a Harmonious Civilization

Changes of historical civilizations occurred spontaneously and were accompanied by violence such as wars, revolutions, riots, terrorism, and so on. The cardinal difference of a harmonious civilization from all the past civilizations is its conscious birth and development. The first of its self consciousness and identification is the GHA book, "*Harmonious Civilization*" [2], signed for publication on November 3, 2009. This date is recognized in the GHA as the birth day of the harmonious civilization.

The growth of the conscious understanding of civilizational shift characterizes a number of international conferences 2010/11. A new civilization begins to realize itself at once in different spiritual dimensions and in different sciences. The transition from intuitive to scientific understanding of the new social reality is expressed by conscious creation of *the ABC of Harmony*, which begins purposeful development and application of scientific thinking of a new civilization.

#### Model-1. The main feature of a harmonious civilization

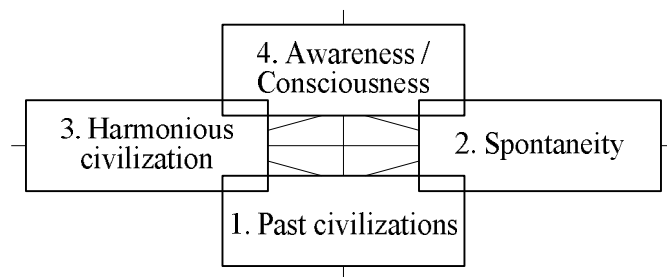

### Birth of Harmonious Civilization/Noosphere in 2009

The preparation and birth of a harmonious civilization has occurred throughout the entire history of mankind. Harmonious civilization is inevitable as the single way for survival and sustainable development of humanity. It is evidently. In a special article provides a list of about 70 facts of spontaneous global harmonization [2, c. 13-20].

In 2009, this trend was identified by three events of world importance that allow us to define the birth of the global harmonious civilization in that year:

1. The nuclear disarmament up to "zero" between the U.S. and Russia that would be impossible in a militaristic industrial civilization;
2. The emergence of the first conscious theoretical model in the GHA program book "Harmonious Civilization" [2], which first introduced its alphabet, language and thinking; and

3. The conscious formation of mathematics of harmony in the fundamental book of Prof. Alexey Stakhov in 2009 [3], in which he and his followers laid down the arithmetic of a new civilization.

The first economic confirmation of a new civilization can be recognized by the unprecedented philanthropy of 40 American billionaires in 2010, an act that denies all the economic laws of industrialism and is explicable only in harmonism. This is the beginning of an economy of self-limitations of the new civilization.

These four events are now the four cornerstones of this harmonious civilization.

Social confirmation of the harmonious civilization at the regional level occurred with the creation of the European Union in 1992 as well as China, building, albeit still rather intuitively rather than knowingly, a harmonious society in its territories, with a population of around 2 billion people – almost the third of humanity – since 2006.

These facts allow us to state that humankind entered the threshold of a harmonious civilization/noosphere and a new "axial age" (Karl Jaspers) [4] as well as into its own inevitable future.

**Model-2.** The first signs of a harmonious civilization since 2009

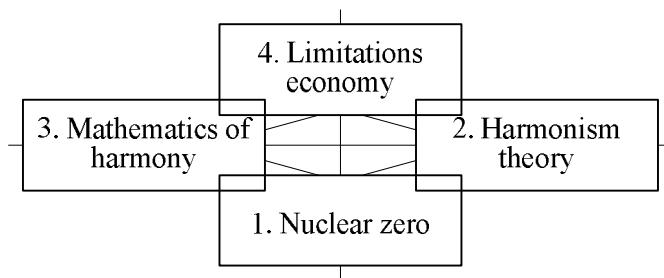

**Spherical Code of Social Harmony**

*The ABC* unfolds the deep structure of social harmony. Its code cannot be represented by hundreds of branches of industrialism or millions of its firms. Social harmony is rooted not in them and at the level of societal spheres at the utmost large parts of society ensuring its complete harmony at the deepest structural level.

Therefore, all *the ABC* fundamental elements are spheres, the harmony of which defines the harmony of all their industries/branches and other smaller pieces. The spheres, because of their utmost large scale, are not available through the physical senses but only through a theoretical vision. This is in contrast to the parts of the industrial society – industries, corporations, firms, and so on – that can be experienced through sensory perception. Therefore, the spherical structures and elements are deep and invisible, while, on the surface, only certain small parts are visible.

Therefore, harmonious civilization requires learning to think by the spheres but not in industries/branches. This requirement is fully met by *the ABC of Harmony*. Only on this level can a harmonious way of thinking about harmonious wholeness of society and individuals be achieved. By only spheres are expressed the deep structure of the code of social harmony.

**Model-3.** Codes of industrialism and harmonism

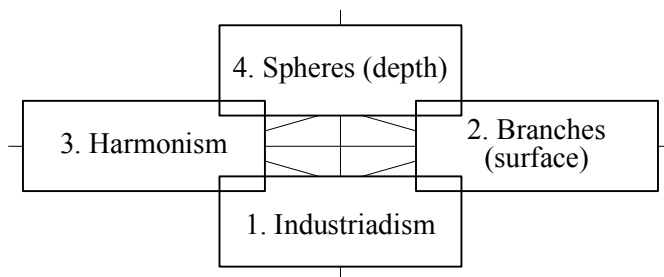

### The most short definition of the alphabet of harmony:

It is the 20 fundamental, necessary, sufficient and coherent elements/spheres of society that express the most deep structure of social harmony and define the infinite variety of its manifestations.

### Axiom of Social Harmony

Axiom of social harmony: The harmonious existence of a society in any place and at any time is defined by four necessary and sufficient resources:

- **People (P)**,
- **Information (I)**,
- **Organizations (O) and**
- **Things (T)**. (Things are any material benefits and services).

These resources are expressed in the chain: People (P) – Information (I) – Organization (O) – Things (T). In the acronym: P-I-O-T, or: PIOT.

### Five Clusters of Harmony Elements

*The ABC of Harmony* consists of five necessary, sufficient and coherent groups/clusters of the fundamental elements of social harmony: **resources – processes – structures – classes – individual/human**.

PIOT's basic resources are in a closed cycle of the **processes** from their production, where they arise, through their distribution and exchange to consumption, where they disappear.

PIOT resources, together with their closed processes, create the **structures/organizations** or **spheres** of their production and consumption.

The people employed in these structures comprise the large groups of the population and make the relevant **spherical classes** and **spherical social structure** of any society.

PIOT resources, as a social macrocosm, are impressed in microcosm of the **individual/human** as its internal similar complex of spherical resources, defining his/her life and harmony.

All the infinite variety of objects, structures, properties and relations of the social world are summarized in these five clusters and reduced to it. Therefore, the ABC, which includes them, is universal for the social world. The ABC embraces its diversity, which aspires to harmony as a sustainable development of this world and the most optimal state of it.

The clusters of harmony elements are inseparable, interrelated and coordinated, resulting in a notion of coherence. Ontologically, epistemologically and dialectically, the harmony and all clusters of its elements are coherent, i.e. they agree in their inseparable interrelation, which creates integrity/wholeness of any social harmony on any level.

### Model-4. Five clusters of the ABC of Harmony

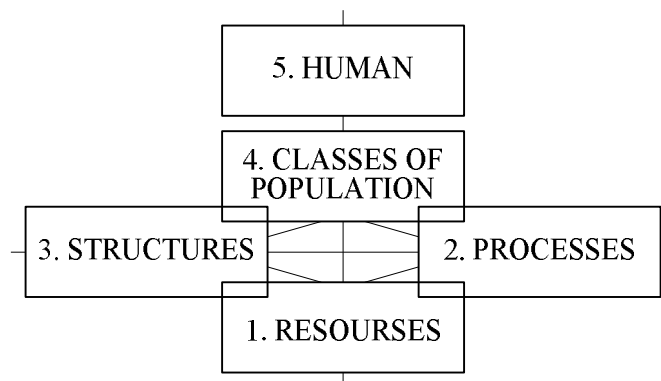

### Tetra-structure of Clusters

*The ABC* clusters have tetradic (four-field, four-dimensional) structure: each contains the four different elements. This structure is the most adequate and sufficient for the expression of harmony and its integrity at every level of the social world. The tetra-structure of clusters

determines the harmonic content of tetranet thinking. It is fundamentally different from disharmonious and partial industrial thinking based on the triadic structures [1, c. 17-20].

The tetra-structures are as ancient as the world. Pythagoras, Empedocles, Plato and many other thinkers of all cultures and times to the present time have described them [5, 23–30]. But just at present, in this era of birth of a harmonious civilization, they are required to be used as the basic cells of a fundamentally new, harmonious, tetranet thinking. It is therefore not surprising that the ABC of this thinking has tetradic structure.

The clusters' tetra-structure corresponds to the tetra-structure of the elements of harmony, which provides them mutual inclusion according to the fractal principle: "all are in all." This structure defines the highest qualities of harmony in which its integrity/holism and completeness are both ontologically and epistemologically found in harmonious thinking. Interdependence of these qualities as well as their relevant concepts are expressed by the chain and tetramodel-9: harmony – tetra-structure – harmony integrity – harmony fullness.

**Model-5. Qualities of harmony**

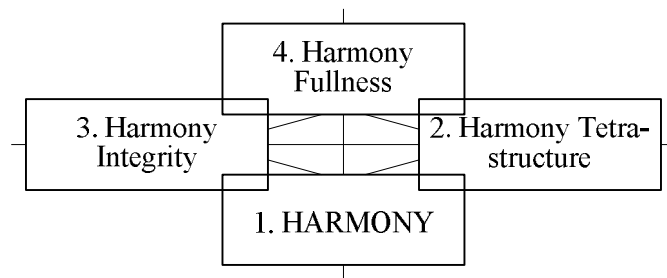

**Necessary, Sufficient and Coherent Nature of Harmony Elements**

Integrity and fullness of harmony are specified and detailed in the necessity and sufficiency of its elements. The necessity and sufficiency is the strongest logical argument on which is built the logical consequences. The ancient and best example of this necessity and sufficiency of the four elements was distinguished by the sages of ancient Greece who identified land, water, air, and fire. Each of these elements is necessary. Correspondingly, the absence of any one of them makes life on Earth impossible. Only together do they make up the sufficient conditions for life's existence.

The logic of necessity and sufficiency of the ABC's five clusters of harmony and their 20 elements is similar. This is the fundamental characteristic of the harmony elements. The necessity and sufficiency of the elements are inseparable from their coherence, consistency and proportionality. But if the first two qualities (necessity and sufficiency) of the elements reflect the impossibility of the existence of each element separately, without the others, then coherence expresses them in coordination and proportional dependence of each element from the others. Therefore, the harmony of the elements is expressed through the relationship of the three inseparable qualities: necessity, sufficiency and coherence.

**Model-6. Qualities of elements of harmony**

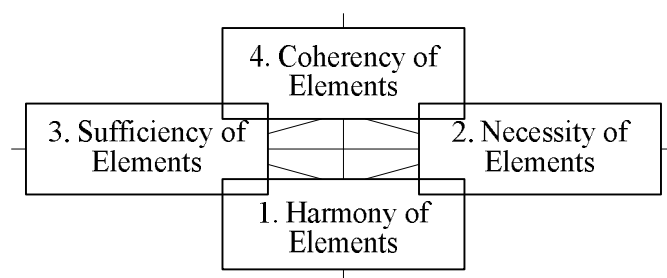

### Cluster 1: Resources

The main cluster of fundamental elements of social harmony in its *ABC* consists of four spherical PIOT resources. They are defined by the axiom above. Each spherical resource is empirically evident on a superficial level, but, as a whole, they are invisible and require theoretical definition in a static state outside of motion. This creates the **social statics of harmony**.

PEOPLE are the priority social resource and harmony actor because they possess the unique quality (ability) to make all other resources, including themselves. People include all human beings from the moment of birth as all the human population. Zero population/people is a zero of society, a situation that expresses the necessity of this element.

The same logic of necessity is for three other social resources: zero each have zero society that expresses the necessity of these elements.

In PIOT, another important feature is coherency and their mutual inclusion as "all in all" or "everyone in every one." This means that each of these resources includes and cannot exist without the participation of all other resources. The priority among these resources the one determines the quality of each resource, and only that circumstance allows us to carry it to one of the four classes of resources. This ontological feature of resources is the cause of the epistemological difficulties and errors of classification of resources. Internal and external coherence of PIOT resources determines their internal and external social harmony. A more detailed description of these resources, their dialectics and their different priority are presented in the book [6, 186–200].

#### Model-7. PIOT Resources

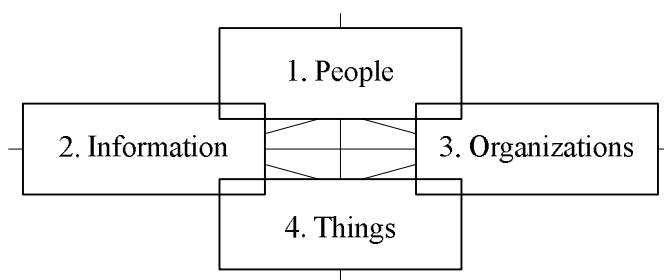

### Cluster 2: Processes

None of the PIOT resources is found in nature as a finished and ready-made product. Therefore, a society and individuals are compelled to reproduce them continuously throughout their entire life from birth to death. This is known as reproductive employment [5, 35–46]. As Adam Smith and Karl Marx showed, each PIOT resource passes four necessary and sufficient processes of reproduction:

- **Production (P),**
- **Distribution (D),**
- **Exchange (E) and**
- **Consumption (C),**

They constitute a closed cycle from the emergence of the resource in production until its disappearance in consumption. The PDEC processes represent extremely large functional spheres of social relations that constitute the **social dynamics of harmony**.

The PDEC processes are coherent and mutual inclusive, that is, production of any product requires consumption of all PIOT resources in certain proportions. Harmony of social resources and harmony of social processes (functions and relations) are mutually dependent on each other, but the primary role play PIOT resources. Through their harmony is expressed the harmony of PDEC process in their knowledge and statistical expression (see below).



### Model-8. PDEC Processes

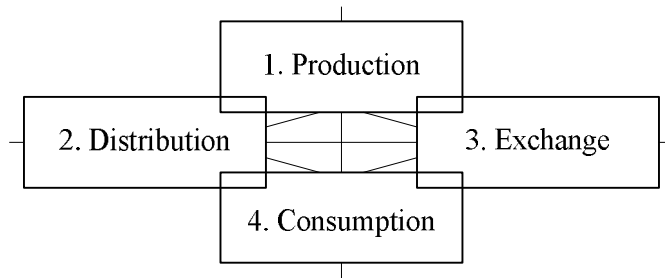

### Cluster 3: Structures

PIOT resources are inseparably connected with PDEC processes, forming the fundamental social structures of four spheres of social reproduction. They differ in the final product/resource that they produce. The PIOT resources are the subject and the product of the four necessary, sufficient and coherent structures/sphere of social reproduction:

- *Social sphere, or Sociosphere (S), the subject and the product of which are people (P);*
- *Information sphere, or Infosphere (I), the subject and the product of which is information (I);*
- *Organizational sphere, or Orgsphere (O), the subject and the product of which are organization/s (O);*
- *Technical (economic/ecological) sphere, or Technoecosphere (T), the subject and the product of which are things (T).*

The SIOT structures are extremely large social systems, which are called spheres of reproduction and constitute the **social structuratics of harmony**. These spheres combine old PIOT resources and PDEC processes for reproduction of new PIOT resources. These spheres are inseparable, coherent and mutual inclusive, so no one sphere of production cannot exist separately from the other spheres. Therefore, they are equally necessary, which means that no one is more primordial than the others. They produce a similar from similar through others, that is, every PIOT product is made from the appropriate resource(s) with and through other resources. These spheres define the structure of social needs, abilities, employment, labor, property, money, distribution, exchange/market, consumption, and so on. SIOT structures are structures of reproduction not only in society with all its resources and processes but also the social harmony of the whole together with them – if they are coherent. But if the SIOT structures are disharmonious and insufficiently coherent, as in an industrial society, they reproduce social disharmony as a whole. Therefore, harmonious development of society is dependent on the harmonious development of its SIOT spheres in their unity and coherency of mutual limitations.

### Model-9. SIOT Structures

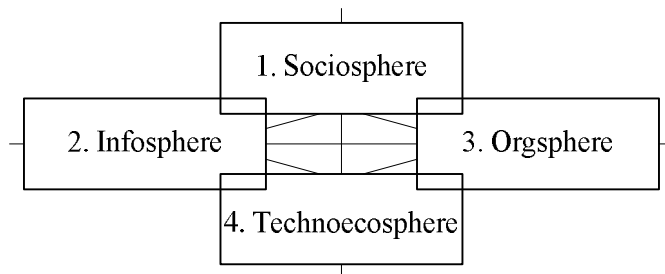

### Cluster 4: Classes

SIOT spheres cover the entire population. They include each person from birth to death. All personal life activities are represented as reproductive employment in these spheres and change (replacement) of this sphere employment in time. It is a whole **universal reproductive employment** for the entire population and for every individual. Therefore, the eternally existing

SIOT spheres divide the entire population, without exception, into four eternally existing spherical classes. The population classes occupied (employed) in the SIOT spheres of social reproduction are:

- ***SOCIOCLASS, people who are employed in the sociosphere;***
- ***INFOCLASS, people who are employed in the infosphere;***
- ***ORGCLASS, people who are employed in the orgsphere;***
- ***TECHNOCLASS, people who are employed in the technoecosphere (economical/ecological sphere).***

The abbreviation of these classes is the same as for the structures (Cluster 3), so we will differentiate them by adding the word "class" to these: "SIOT-classes."

The SIOT classes are differed not in particular or temporal attributes of private property (like Marx) or stratification (as in empirical sociology) but in universal spheres of the SIOT employment. Employment in these spheres is key criterion for these classes. Therefore, they are referred to as **SPHERAL classes of the population** (SIOT-classes).

The spherical classes of the population are universal, necessary, sufficient and coherent as is the case with spheres in which they are employed. Therefore, they are the primary and permanent actors of social harmony. However, antagonistic economic classes (Marx) constantly exist on the surface to dominate the industrial civilization, determine its disharmonious nature and neutralize the spontaneous harmony of spherical classes. They become the full actors of social harmony, when they become conscious, based on knowledge of alphabet (*ABC*), language and thought of harmony. This occurs in a harmonious civilization, which they consciously create and constantly reproduce.

The human simultaneously belongs to all classes, as each day he/she is busy in each sphere even for a minimum of time. However, at each life stage, the sphere that takes the most of an individual's time has a priority. At each life stage, the individual's class identification (class membership) is determined by this criterion. Therefore, the spherical classes are "soft," without distinct economic and other boundaries, and do not prevent them from being the most profound and fundamental to the social harmony as a whole. In contrast and on the surface of society, there are also people who are historically transient and limited in both class and group structures; these are known as partial classes or groups.

The partial classes/groups dominate in all disharmonious civilizations that have preceded the harmonious one. The consequence of their presence (or even dominance) in every sphere is suppression of and violence toward other spheres and classes. We find four forms of these partial classes/groups:

1. Economic, which is realized by the economically dominant classes and applies not only to other spheres and classes but also to nature. Economic suppression is the priority in industrialisms and manifests itself in continuous wars of trade and competition.

2. Political, which is made by the politically dominant classes and is manifested in the continuous political wars, violent revolutions and wars between states.

3. Information, which is realized by the informational dominant classes and is manifested in continuous derogatory or defamatory information designed to divide the population and create ideological wars.

4. Social, which is made by the socially dominant classes and is manifested in the continuous wars over religion, gender, inter-generations and so on as well as in genocide.

These wars are often accompanied by the use of weapons, crises, and degradation, which ultimately lead to the destruction of the whole (including those who created the wars) and creation of a new separate, evolved state or civilization such as the demise of the industrial civilization and the rise of the harmonious civilization. The suppression by other spheres and classes, i.e. society in general, by the partial classes first occurs through violence and war. This is the first sign of a typical social pathology and disharmony. It is the manifestation of ignorance of harmony – the necessary coherence – of all spheres and sphere classes. In contrast, the conscious spherical classes – those owning a basic *ABC* understanding of harmony as well as the language,

thinking, and theory of harmony – will create a society that excludes all forms of violence of the partial over the whole.

Together with the SIOT spheres, the SIOT-CLASSES constitute a deep social structure in a whole or deep structure of social harmony in a whole. During the pre-harmonious history of humankind, they acted as spontaneous, intuitive and unconscious actors of harmony. They have since become conscious actors of a harmonious civilization, mastering scientific knowledge of the *ABC* of social harmony. Therefore, today, there is a differentiated spontaneous and conscious cultivation of harmony by society and the individual. SIOT-CLASSES define the **social occupatics of harmony** or universal occupation/employment by harmony. The term "occupatics" is made from an English word "occupation," which means any employment or any kind of activity.

**Model-10. SIOT Classes**

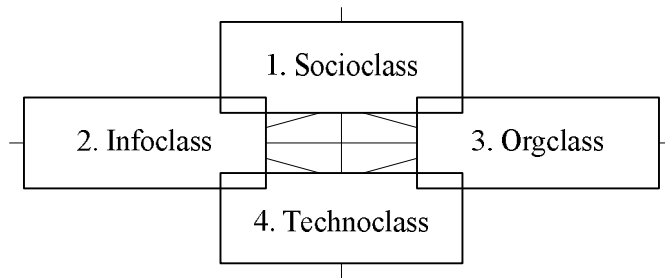

The considered four clusters of elements of harmony express society in a whole and its integral harmony on all levels. Inseparability and the relationship between these elements are represented graphically in Scheme-1 – Socionome (below).

**Cluster 5: Human**

Society cannot be understood without humans and vice versa. They relate both as macro- and micro- cosmoses, just as do the atom and the universe or the drop and the ocean. Therefore, society and the human are the same in their fundamental, deep, spheral structure. To the four spheres of society (SIOT) correspond the four fundamental spheres of reproduction/life of each individual/human:

- **CHARACTER (orientation, values and morals);**
- **CONSCIOUSNESS (information and spiritual culture);**
- **WILL (individual order and self-organizing); and**
- **BODY (anatomy, temperament, subconsciousness and physiology).**

To the four spheres of human (CCWB) correspond the four kinds of individual needs, abilities, work, employment, property, distribution and exchange.

The spheres of the individual are interconnected. Therefore, harmonious development of an individual is a harmonious development of these spheres in their unity and coherency of mutual limitations. The individual spheres represent the extremely large psycho- socio- physio complexes that define **individual structuratics of harmony**. The human spheres (CCWB) are also as necessary, sufficient and coherent as the society spheres (SIOT), which are an external extension and embodiment of the internal individual spheres.

The SIOT spheres of social harmony are not possible without the CCWB spheres of individual harmony and vice versa, which means that the individual spheres are included in the elements of social harmony.

### Model-11. Individual Spheres

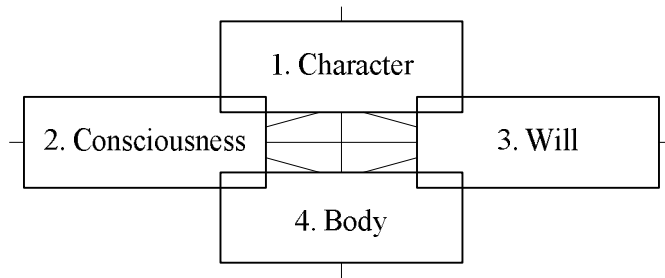

### Socionome of a Society and Psynome of a Man as Integral Images of Society and Man in the ABC of Harmony

The elements of social and individual harmony mentioned above need to be integrally summarized and to have a united image so that each of 20 the elements will find its own place in a holistic and logically organized structure. The best similitude for such a structure is the genome. The ABC of Harmony deals with two genomes: the social genome of the society, which we will call by means of a new term, SOCIONOME, and the psychological genome of the human, which we will call by means of another new term – PSYNOME.

The Socionome of a Society is the social genome of any society represented by the integral summary of 16 fundamental interrelated elements/spheres of social harmony, which constitute the deep structure of society in whole and guarantee its stable life.

The Psynome of a Man is the psychological genome of a man or woman represented by the integral summary of four fundamental interrelated elements/spheres of individual harmony that constitute the deep structure of man in whole and guarantee his/her stable life.

Socionome and psynome are similar in structure but different in consisting elements. Socionome and psynome express their fundamental dialectical and harmonious properties: coincidence, identity in the deep structure of society and man. But they differ and contrast in elements, filling this structure at the level of society and at the level of man.

Socionome and psynome are represented in large graphical, integral schemes. The first scheme is below, the second, similar, is presented in the book [1, 44–45].

#### Definitions, Explanations and Notes to the Socionome. Definitions:

1. Socionome of a Society is the social genome of any society represented by the integral summary of 16 fundamental relative elements/spheres of social harmony that constitute the deep structure of society in general and guarantee its stable life.

2. Social Harmony is the consent (adequacy, proportion, coherence) of any sphere of society as a part within the whole and in regard to other spheres or parts.

3. Harmonization of Society assigns the property of consent to all interrelations of the elements/spheres of society, as represented in the scheme.

#### Explanations to the Socionome:

1. This scheme demonstrates four equally necessary and, together, sufficient spheres of any society as its eternal structural-functional frame, which I called: the socionome of society.

2. The socionome of society is similar to the eternal psychological genome of a man (see below) because the macrocosm is similar to the microcosm.

3. Production and consumption processes are represented in one module of the scheme that expresses their continuity and coincidence: production is consumption and vice versa.

4. Exchange as a market, where demand and supply meet, is a spontaneous regulator of harmony (balance) of four spheres of social production, which turns into a conscious, much more effective regulator of social harmony along with its knowledge.

#### Notes to the Scheme-1:

1. The similar Scheme was first created in 1980, more than 30 years ago. But it hasn't been published anywhere for all this time. Its updated version was first published in *the ABC of Harmony* (2012), where it takes its logical place as the integrator of all elements of the social harmony [1, 40-41].

2. The Scheme-1 represents two ontological levels: society and nature, which is planet Earth for a man. In the upper part, there is society in a whole; in the lower part, it is represented as the part of nature in the form of noo- or anthroposphere of Earth in the integrity of its seven spheres.

3. The Scheme-1 demonstrates well that the spheres are the elements of not just social but also of natural harmony. That is why harmony of nature and society passes not through the branches of society but through its spheres interacting with the spheres of Earth. Interaction of every social sphere with the spheres of the Earth is demonstrated in the Scheme. Death of at least one natural sphere means inevitable death of society. The previous century has shown that it is only disharmony of society and man that passes and enlarges through the branches. Consequently, scientific understanding of the global ecological problem is possible not at the level of disharmonious branch thinking of the previous century but at the level of harmonious spherical (tetranet) thinking of the new century. *The ABC* of this thinking consists of 20 fundamental spheres as the elements of harmony. It teaches to think with the harmony of spheres but not with the disharmony of branches.

4. The Scheme represents two levels of thinking: structural (the level of four spheres) and functional (the level of the interactions between four spheres), which logically transforms into a technological level, including IT, by means of the statistical matrix of spherical indices [1, 51-53; 7]. The Scheme covers the objects of harmonization (16 elements) and the technology of their harmonization by means of special statistics and mathematics (ibidem).

5. The Scheme-1 is an integral, holistic model of any social level, from global to family (in some modifications also to atomic – individual), where any positive and negative social processes from ideal harmony to collapse of society may be modeled.

6. Scheme-1 is the most important tool of knowledge and conscious governance of social harmonization at any level; hence this Scheme is an organic part of *the ABC of Harmony*, its knowledge and practical application.

7. Discovery of the socionome is equal to the transformation of sociology to the level of fundamental theoretical science of society in a whole to the level of Tetrasociology as the science of social harmony. Sociology turns from narrowly empiric science to the fundamental theoretical science, connecting all of its broken branch parts in a one whole.

8. Socionome is extremely important not just for sociology but for all social sciences. It is known that, in disharmonious and partial industrial society, they correspondingly develop partially and disharmoniously. It makes them weak in the face of integrity and harmony of the relevant spheres and areas: economics, politics, culture, law, management, and so on. Discovery of the socionome enables every corresponding science to transform from the limited and narrowly empiric science to the fundamental, theoretical science and to overcome interdisciplinary barriers. In this case, such sciences become harmonious and integral and holistic. They rise to the level of thinking not by branches but by spheres. It is a new level of social thinking as a whole.

Scheme-1. SOCIONOME: Eternal Structure of the Society Spheres and their Functioning / Correlations at every Level: Global, Regional, National and Local Including the Human

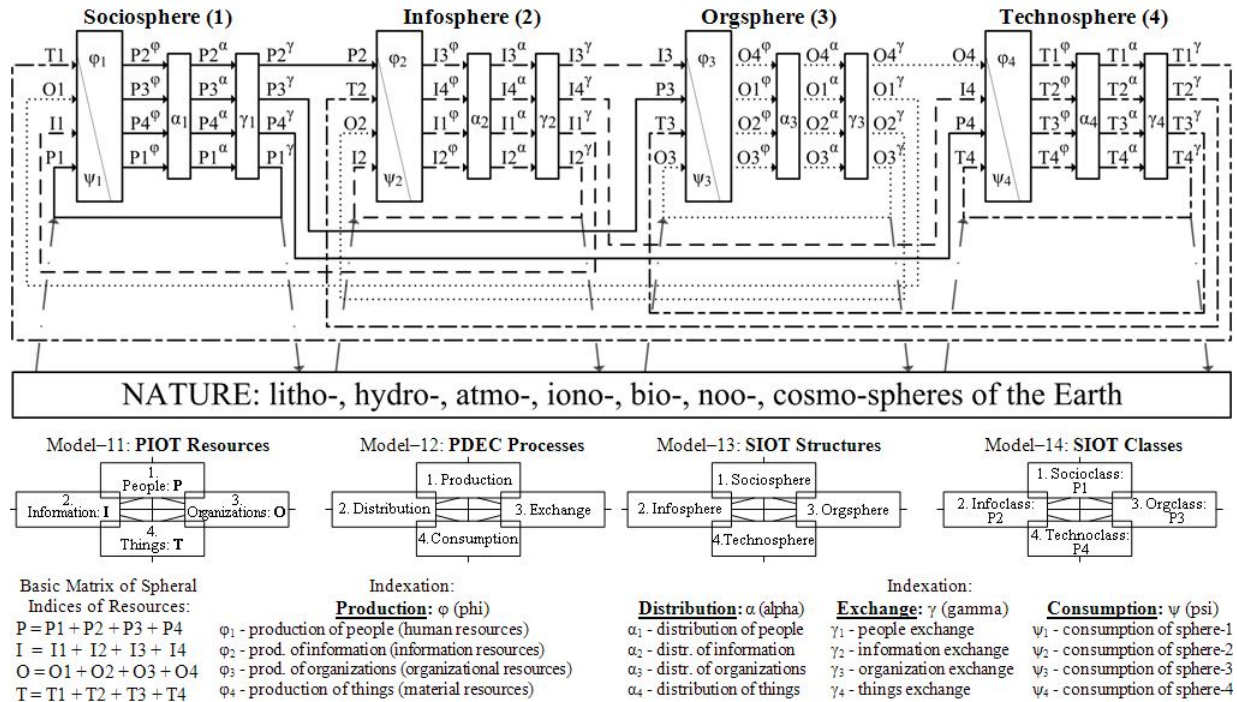

### Rejection and attraction

It is well known: the old rejected a new one that is born within it. Industrial society and sociology reject a harmonious society and its Tetrasociology. This situation is illustrated throughout its history of over 35 years.

Tetrasociology attraction creates a process of global harmonization and the birth of a harmonious civilization. *The ABC of Harmony* opens this civilization by the harmonious global sociology in the 21<sup>st</sup> century and the Age of Harmonious Enlightenment in this sociology. It generalizes the other works devoted to harmony [3; 8; 9; 10; and etc.].

### References

1. Semashko, Leo together with the GHA 75 coauthors from 26 countries (2012) *The ABC of Harmony for World Peace, Harmonious Civilization and Tetranet Thinking*. Global Textbook. New Delhi: Doosra Mat Prakashan.
2. Semashko, Leo together with the GHA 119 coauthors from 34 countries (2009) *Harmonious Civilization. Global Harmony Association Innovative Projects*, St-Petersburg: LITA
3. Stakhov, Alexey (2009) *The Mathematics of Harmony. From Euclid to Contemporary Mathematics and Computer Science*. Canada: World Scientific.
4. Jaspers, Karl; Bullock, Michael (Tr.) (1953) *The Origin and Goal of History* (1<sup>st</sup> English ed.). London.
5. Semashko, Leo (2002) *Tetrasociology: Responses to Challenges*. St.-Petersburg: Polytechnic University.
6. Semashko, Leo (1999) *Sociology for Pragmatists*, St.-Petersburg: European House.
7. Semashko, Leo (2000) *Tetrasociology as the Revolution of Social Thinking, the Way of Harmony and Prosperity*. St.-Petersburg: LITA
8. HRH The Prince Of Wales; Tony Juniper; Ian Skelly (2010) *Harmony: A New Way of Looking at Our World*, London: Harper Collins Publishers, Blue Door
9. Brahma Kumaris Spiritual University (1993) *Universal Harmony*, India
10. Baimuratov, Uraz (2010) *Harmony of Society and Economy: Global Paradigm*, Almaty 27/08/12



## Appendix 2

### Nicholas Roerich: 13 Paintings of the Interfaith Harmony Leaders

Interpretation of published below Nicholas Roerich's paintings is presented in Julia Budnikova's article, Deputy Director for exhibition work at the Roerich Family Museum and Institute, St. Petersburg, Russia. This article is published in the project.



**Mother of the World. 1924**



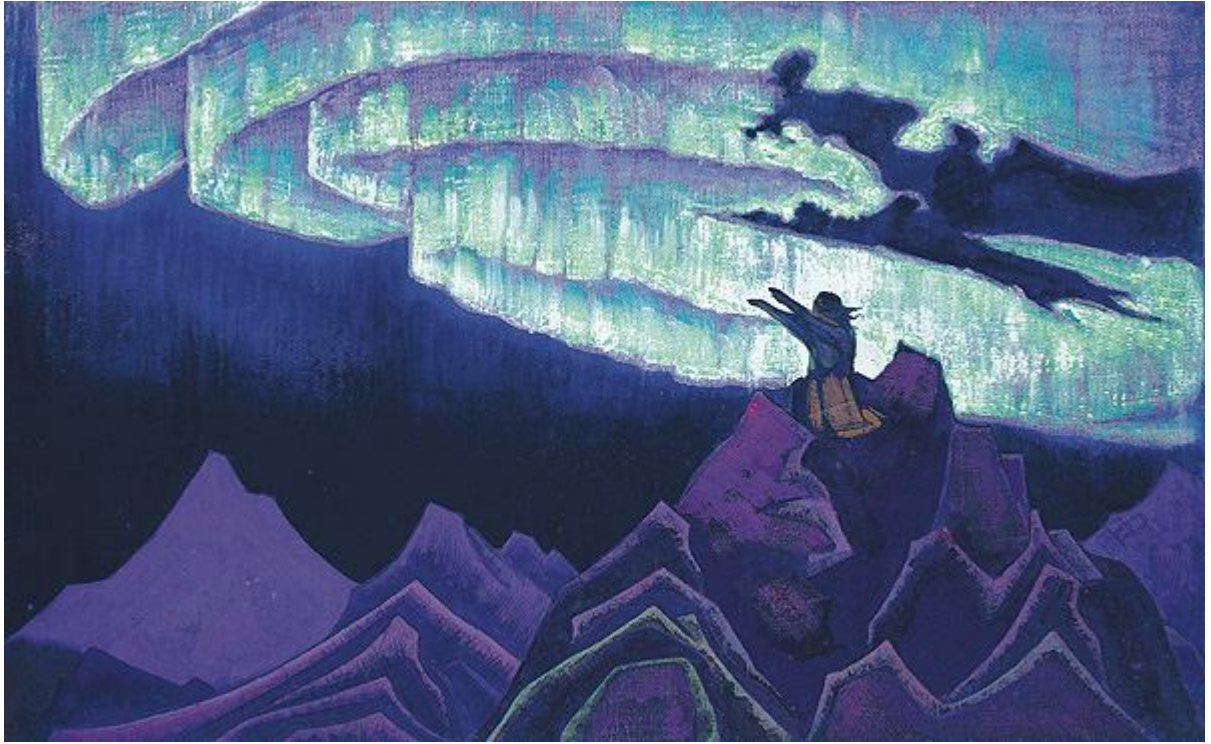

**Moses, the Leader. 1925**



**Buddha, the Conqueror. 1925**





**Confucius, the Just one. 1925**



**Lao Tze. 1924**





**Signs of Christ. 1924**

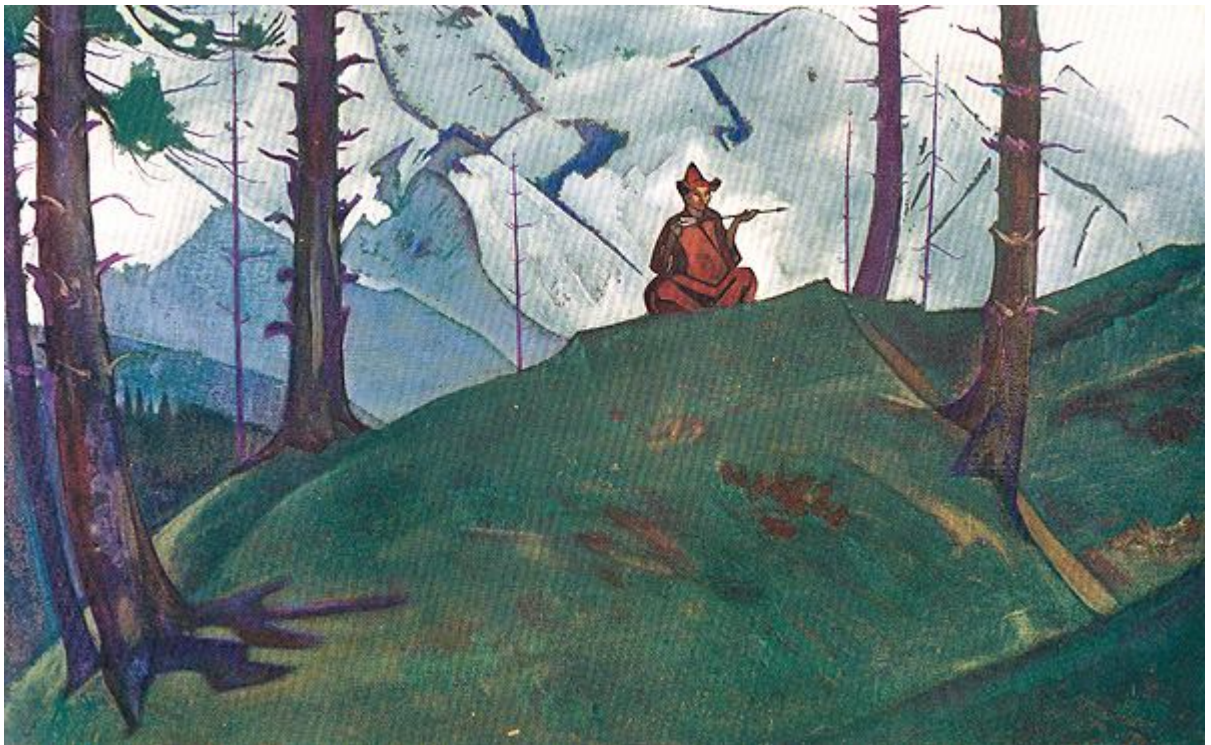

**Sarakha - the Blessed Arrow. 1925**





**Nagarjuna, the Conqueror of the Serpent. 1925**

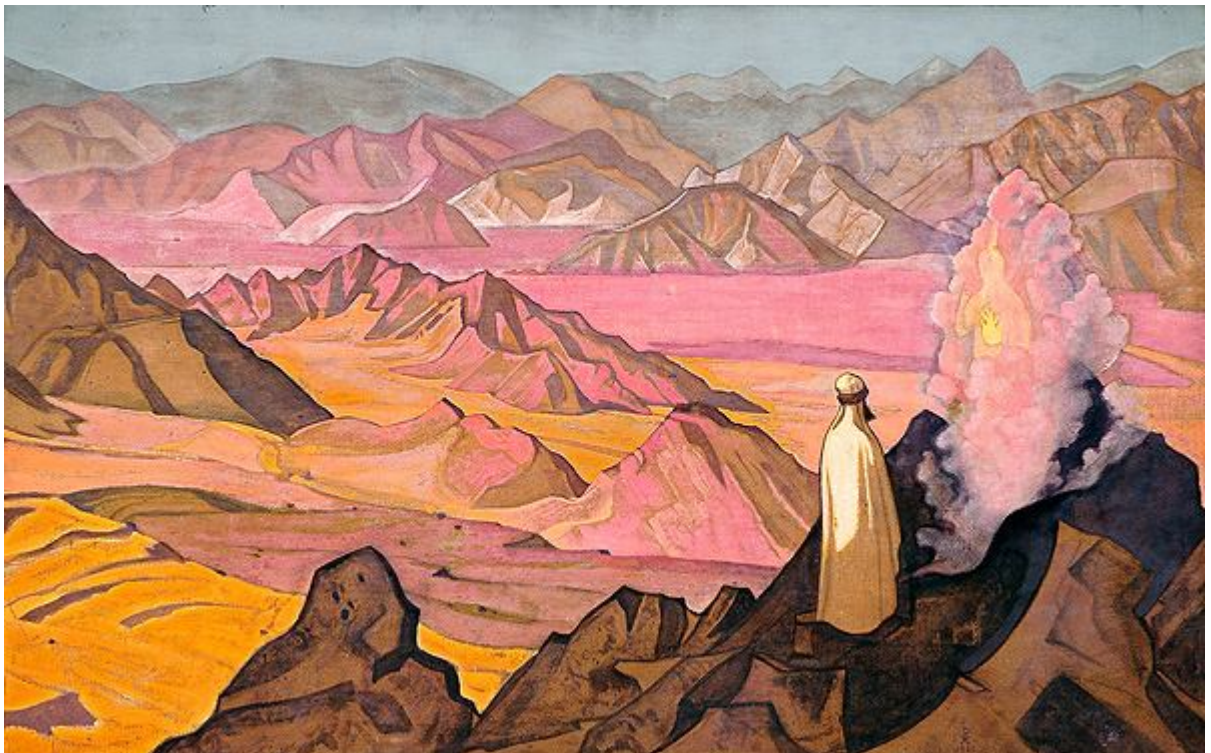

**Mohammed on Mount Hira. 1925**



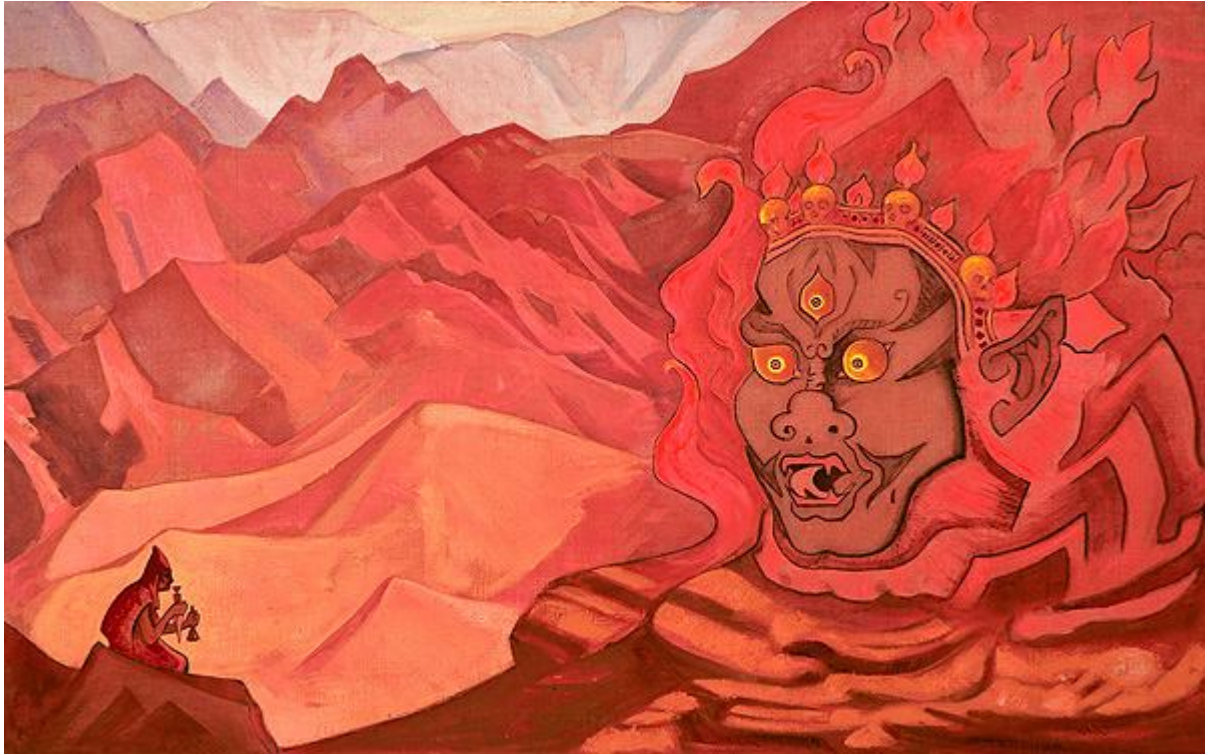

**Dorje, the Daring one. 1925**



**Padma Sambhava. 1924**



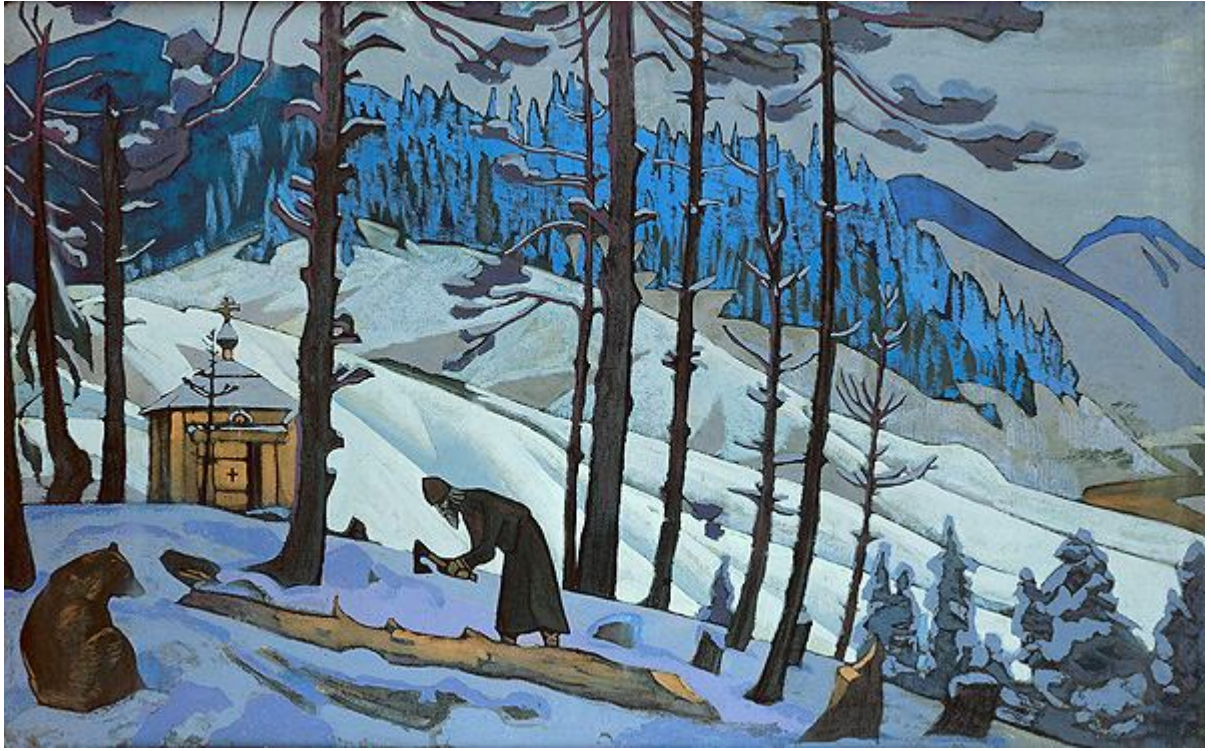

**Sergius, the Builder. 1925**

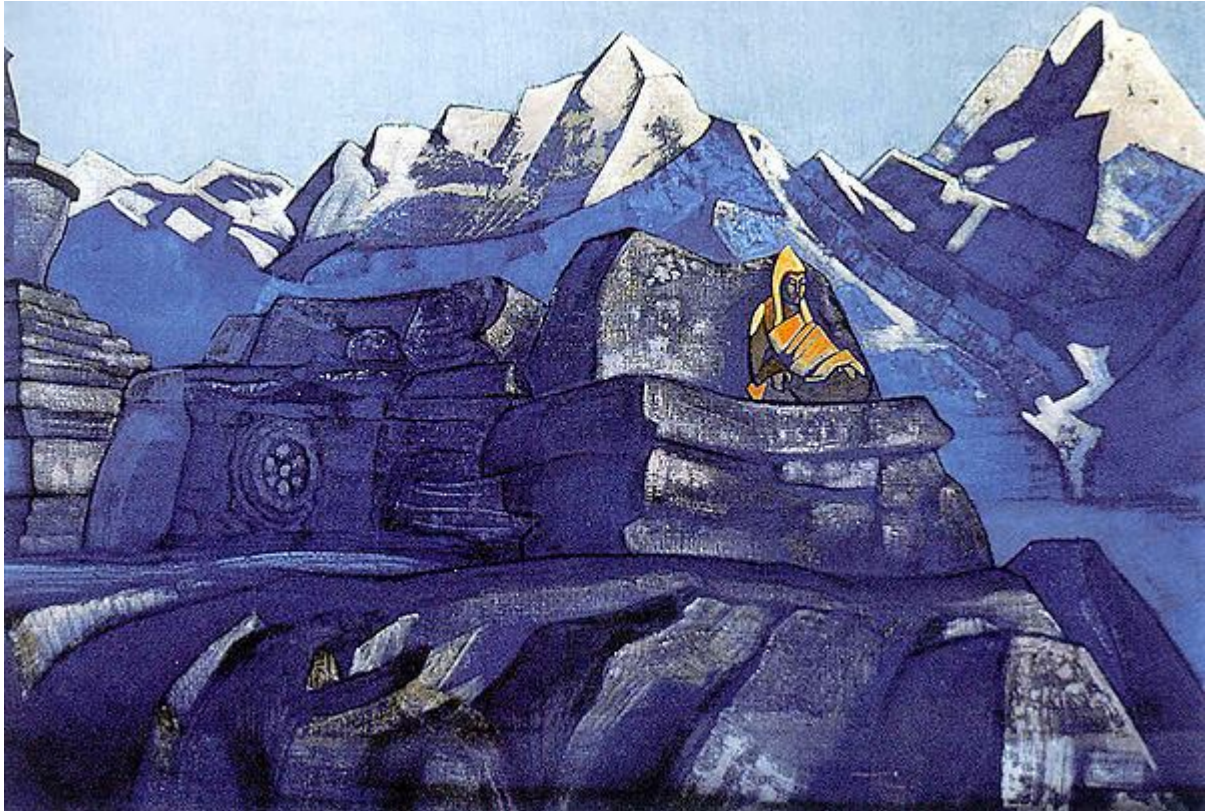

**Tsong-Kha-Pa. 1924**

## Appendix 3 The Project Authors List with Brief Information

### 1. Celia Altschuler

Catholic faith,  
Acting President, GHA-LAC,  
GHA Ambassador for Peace and Disarmament from Harmony in LAC,  
Artist, Poet, Translator,  
French Professor, Media Producer,  
**Address:** Parguera, Puerto Rico  
**Phone:** 787-462-1031  
**E-mail:** [psoleil5@yahoo.com](mailto:psoleil5@yahoo.com)

### 2. Ayo Ayoola-Amale

Catholic faith,  
Poet, Writer, Lawyer,  
Senior Lecturer & Head of Department of Law, Fac of Law, Kings University,  
GHA Vice-president, GHA-Africa President & Ambassador of Harmony for Africa,  
Founder/President Splendors of Dawn Poetry Foundation.  
**Address:** Accra, Ghana and Nigeria  
**Web:** [www.peacefromharmony.org/?cat=en\\_c&key=524](http://www.peacefromharmony.org/?cat=en_c&key=524),  
[www.splendorsofdawnpf.org](http://www.splendorsofdawnpf.org), [www.ayor.webs.com](http://www.ayor.webs.com)  
**E-mail:** [ayo@splendorsofdawnpf.org](mailto:ayo@splendorsofdawnpf.org)

### 3. Daurenbek Aubakir

Muslim faith,  
Ph.-Math.C., Ph.D., member of the Academy of IIA and ISAESNM, Professor Department of System Analysis and Control of Physics and Technology Department of L.N. GumilyovENU, Astana (Kazakhstan). Author of the book: "*Harmony in science, technology and life - an inexhaustible source of life and the perpetual motion of the intellect*" (Almaty, 2001, 200 p.).  
**Address:** Astana, Kazakhstan  
**Mobile:** +7-701-367-79-33.  
**E-mail:** [segiz-seri@yandex.ru](mailto:segiz-seri@yandex.ru)

### 4. Reimon Bachika

Shinto faith,  
Professor Emeritus (Dept Sociology) Bukkyo University, Kyoto, Japan. He is one of founders of the GHA.  
Coauthor, *The ABC of Harmony*: [www.peacefromharmony.org/?cat=en\\_c&key=478](http://www.peacefromharmony.org/?cat=en_c&key=478).  
**Address:** Yamamotodori 3-3-10 6F., Chuo-ku, KOBE, 650-0003 Japan  
**Web:** [www.peacefromharmony.org/?cat=en\\_c&key=24](http://www.peacefromharmony.org/?cat=en_c&key=24)  
**E-mail:** [rbac05yamk@yahoo.co.jp](mailto:rbac05yamk@yahoo.co.jp)

### 5. Uraz Baimuratov

Muslim faith,  
GHA Ambassador of Peace and Disarmament from Harmony,  
Academician of the National Academy of Sciences of the Republic of Kazakhstan,  
Doctor of Economics, Professor, Honored Worker of Science of Kazakhstan,  
Director of the Institute of Finance & Banking Management,  
Author of the book: "*Harmony of Society and Economy: World Paradigm*" (2010)  
**Address:** Almaty, Kazakhstan  
**Web:** [www.peacefromharmony.org/?cat=ru\\_c&key=561](http://www.peacefromharmony.org/?cat=ru_c&key=561)  
**E-mail:** [uraz.baimuratov@gmail.com](mailto:uraz.baimuratov@gmail.com)



## 6. Ammar Banni

Muslim faith,  
Professor of education,  
Poet & Writer. GHA Honorary Member since 2007. GHA Honorary Poet of Peace from Harmony for 2008. Famous Algerian and Moslem peace lover.  
Coauthor, *The ABC of Harmony*: [www.peacefromharmony.org/?cat=en\\_c&key=478](http://www.peacefromharmony.org/?cat=en_c&key=478)  
**Address:** Guemar, Algeria  
**Web:** [www.peacefromharmony.org/?cat=en\\_c&key=288](http://www.peacefromharmony.org/?cat=en_c&key=288)  
**E-mail:** [ammarbanni@yahoo.fr](mailto:ammarbanni@yahoo.fr)

## 7. Julia Budnikova

Orthodox Church,  
was graduated from the Philological Faculty of St. Petersburg's State University in 1988. She currently holds the position of Deputy Director for exhibition work at the Roerich Family Museum and Institute, St Petersburg, Russia. Coauthor, *The ABC of Harmony*.  
**Address:** St Petersburg, Russia  
**Web:** [www.roerich.spb.ru](http://www.roerich.spb.ru)  
**E-mail:** [jb@roerich.spb.ru](mailto:jb@roerich.spb.ru)

## 8. Tholana A. Chakravarthy

Hindu faith,  
Litt.D, GHA Vice-president,  
Co-Director, Embassy of Human Rights from Harmony and Justice, Ambassador,  
International Poet-Review Writer; Universal Peace Ambassador,  
Coauthor, *The ABC of Harmony*: [www.peacefromharmony.org/?cat=en\\_c&key=478](http://www.peacefromharmony.org/?cat=en_c&key=478).  
**Address:** Hyderabad, INDIA  
**Web:** [www.worldpeacepoetry.com](http://www.worldpeacepoetry.com), [www.peacefromharmony.org/?cat=en\\_c&key=286](http://www.peacefromharmony.org/?cat=en_c&key=286)  
**E-mail:** [taevorthy@gmail.com](mailto:taevorthy@gmail.com)

## 9. Bruce L. Cook

Catholic faith,  
Ph.D., GHA-USA Acting President. GHA Ambassador of Peace and Disarmament from Harmony. Publisher and Editor. President, World Writers Resources, Inc. Author, *Harmony of Nations*: 1943 – 2020, Just Fiction Editions, 2012.  
**Address:** 7337 Grandview Ct. Carpentersville, IL 60110 USA  
**Phone:** 312-859-8090  
**Web:** [www.harmonyofnations.com](http://www.harmonyofnations.com), <http://author-me.com>,  
[www.peacefromharmony.org/?cat=en\\_c&key=544](http://www.peacefromharmony.org/?cat=en_c&key=544)  
**E-mail:** [cookcomm@gmail.com](mailto:cookcomm@gmail.com)

## 10. Robert D. Crane

Muslim faith,  
GHA Vice-President,  
Dr., Full Professor - Center of the Study of Contemporary Muslim Societies  
Qatar Faculty of Islamic Studies  
Hamad Bin Khalifa University  
**Address:** P.O Box: 34110 Doha, Qatar  
**Tel:** +974 445 42822 **Fax:** +974 445 46620 **Mob:** +97466766013  
**Web:** [www.qfis.edu.qa](http://www.qfis.edu.qa)  
**E-mail:** [rcrane@qfis.edu.qa](mailto:rcrane@qfis.edu.qa)

## 11. Dmitry Delyukin

Orthodox Faith.

He has graduated from the Philology faculty of Saint-Petersburg State University in 1994. Now is the employee of Saint-Petersburg State Museum-institute of Roerich family. Coauthor, *The ABC of Harmony*: [www.peacefromharmony.org/?cat=en\\_c&key=478](http://www.peacefromharmony.org/?cat=en_c&key=478).

**Address:** Saint-Petersburg, Russia

**E-mail:** [dimdel10@yandex.ru](mailto:dimdel10@yandex.ru)

## 12. Pravat K. Dhal

Hindu faith,

PhD, M.SC., M.ED., GHA-India member,  
Principal, Grizzly College of Education.

**Address:** Koderma, Jharkhand (state), India

**Mob.:** +919430774502

**E-mail:** [pravatkumar.dhal@gmail.com](mailto:pravatkumar.dhal@gmail.com)

## 13. Michael Ellis

Buddhist faith,

MD, BA (Hons), GHA Ambassador of Peace from Harmony for Australia,  
Doctor of Medicine,  
President, THE GLOBAL PEACE CENTRE

**Address:** Melbourne, Australia

**Web:** [www.peacecentre.org](http://www.peacecentre.org), <http://vergemm.com/>, [www.xcellentu.com](http://www.xcellentu.com)

**E-mail:** [mindquest@ozemail.com.au](mailto:mindquest@ozemail.com.au)

## 14. Michael D. Greaney

Catholic faith,

CPA, MBA; GHA Embassy Co-Director, Human Rights from Harmony and Justice,  
Ambassador

Center for Economic and Social Justice (CESJ).

**Address:** P.O. Box 40711, Washington, DC 20016, USA

**O:** 703-243-5155

**F:** 703-243-5935

**Web:** [www.cesj.org](http://www.cesj.org)

**E-mail:** [thirdway@cesj.org](mailto:thirdway@cesj.org)

## 15. Kurt Johnson

Multifaith,

Rev. Dr. Kurt Johnson, co-author of *The Coming Interspiritual Age* (2013, Namaste Publishing). Ordained in three traditions and with a PhD in evolution, ecology, systematic and comparative biology Dr. Johnson was associated with the American Museum of Natural History for twenty-five years and now teaches at New York City's one Spirit Interfaith Seminary. GHA member. More can be learned at Wikipedia (Kurt Johnson, entomologist).

**Address:** New York, USA

**Web:** [www.isdna.org](http://www.isdna.org), [www.thecominginterspiritualage.com](http://www.thecominginterspiritualage.com), [www.namastepublishing.com](http://www.namastepublishing.com)

**E-mail:** [kurtjohnsonisd@yahoo.com](mailto:kurtjohnsonisd@yahoo.com)

## 16. APJ Abdul Kalam

Muslim faith,

B 1931, is one of the most distinguished scientists of India with the unique honour of receiving honorary doctorates from 42 Universities and institutions from India and abroad. Dr. Kalam became the 11<sup>th</sup> President of Republic of India on 25<sup>th</sup> July 2002. After five eventful years he demitted office on 25<sup>th</sup> July 2007.

The GHA Highest Honorary Title: WORLD HARMONY CREATOR:

[http://peacefromharmony.org/?cat=en\\_c&key=513](http://peacefromharmony.org/?cat=en_c&key=513)

Coauthor, *The ABC of Harmony*: [www.peacefromharmony.org/?cat=en\\_c&key=478](http://www.peacefromharmony.org/?cat=en_c&key=478)

**Address:** No 10, Rajaji marg, New Delhi-110011, India

**Phone:** 011 23793601

**Web:** [www.abdulkalam.com](http://www.abdulkalam.com), [www.peacefromharmony.org/?cat=en\\_c&key=95](http://www.peacefromharmony.org/?cat=en_c&key=95)

**E-mail:** [apj@abdulkalam.com](mailto:apj@abdulkalam.com)

## 17. Tatomir Ion-Marius

Ecumenical faith,

GHA Ambassador of Peace and Disarmament from Harmony in Europe,

Poet and Peace Worker,

*The ABC of Harmony* coauthor: [www.peacefromharmony.org/?cat=en\\_c&key=478](http://www.peacefromharmony.org/?cat=en_c&key=478)

**Address:** Maramures, Romania,

**Web:** [www.peacefromharmony.org/?cat=en\\_c&key=274](http://www.peacefromharmony.org/?cat=en_c&key=274)

**E-mail:** [tatomir@gmail.com](mailto:tatomir@gmail.com)

## 18. Glenn T. Martin

Multifaith,

President, World Constitution and Parliament Assoc. ([www.wcpa.biz](http://www.wcpa.biz))

President, Institute on World Problems ([www.worldproblems.net](http://www.worldproblems.net))

Professor of Philosophy and Chair of Peace Studies at Radford University

([www.radford.edu/gmartin](http://www.radford.edu/gmartin))

Coauthor, *The ABC of Harmony*: [www.peacefromharmony.org/?cat=en\\_c&key=478](http://www.peacefromharmony.org/?cat=en_c&key=478)

**Address:** Radford, USA

**Web:** [www.peacefromharmony.org/?cat=en\\_c&key=428](http://www.peacefromharmony.org/?cat=en_c&key=428)

**E-mail:** [gmartin@RADFORD.EDU](mailto:gmartin@RADFORD.EDU)

## 19. A. K. Merchant

Bahá'í Faith,

Vice-President, Global Harmony Association.

The author is the General Secretary, The Temple of Understanding — India [NGO with consultative status at the United Nations]; National Trustee, Lotus Temple & the Baha'i Community of India. He also serves as Chairperson, Sarvodaya International Trust — Delhi Chapter; Associate Secretary General, Global Warming Reduction Centre; Visiting Faculty, Centre for Cultural Resources & Training, Government of India; Member, Ethics Committee, Ram Manohar Lohia Hospital; subject expert for interfaith harmony & Indian culture, Jawaharlal Memorial Fund.

Dr. Merchant is the author of three monographs:

*Communal Harmony — India's Greatest Challenge* (1991);

*Hindu Dharama evam Bahá'í Dharma — Ek Adhayan* (1999);

*Five Basic Human Values & the Bahá'í Faith* (2009),

and 200 research articles and papers published in international and national journals and as book chapters.

Although ancestry wise from Gujarat, he was born in Myanmar and spent his early childhood over there. He is a member of the Bahá'í community since 1975 and has travelled to some 35

countries and lived in different parts of India — West Bengal, Goa, Tamil Nadu, Karnataka, Jharkhand, Uttar Pradesh, Maharashtra, Jammu & Kashmir; for the last 28 years in Delhi.

**Mailing address:** S – 28, Greater Kailash Part I, New Delhi 110 048, India.

**Telephones:** 011-29237919 / 9810441360

**E-mail:** [akmerchant@hotmail.com](mailto:akmerchant@hotmail.com), [ak9merchant@gmail.com](mailto:ak9merchant@gmail.com)

## 20. Charles Mercieca

Multifaith,

Ph.D.; President, International Association of Educators for World Peace

*Dedicated to United Nations Goals of Peace Education,*

*Environmental Protection, Human Rights & Disarmament*

Vice-President, Global Harmony Association

Professor Emeritus, Alabama A&M University, USA

Hon President & Professor, SBS Swiss Business School, Zurich

Coauthor, *The ABC of Harmony*: [www.peacefromharmony.org/?cat=en\\_c&key=478](http://www.peacefromharmony.org/?cat=en_c&key=478)

**Web:** [www.iaewp.org](http://www.iaewp.org), [www.peacefromharmony.org/?cat=en\\_c&key=129](http://www.peacefromharmony.org/?cat=en_c&key=129)

**E-mail:** [mercieca@knology.net](mailto:mercieca@knology.net)

## 21. Nina Meyerhof

Jewish faith, spiritual seeker,

Ed. D.; GHA Vice-President,

Founder and President, Children of the Earth (COE).

**Address:** Vermont, USA

**Phone:** +802-862-1936

**Web:** [www.coeworld.org](http://www.coeworld.org)

**Skype:** nina\_meyerhof

**E-mail:** [nina@coeworld.org](mailto:nina@coeworld.org)

## 22. Manijeh Navidnia

Moslem faith,

PhD; Assistant Professor in Sociology; Faculty member at Azad University, Garmsar Branch.

She was born in Tehran, Iran, 1964. Specific researches are sociology of security particularly concerning Societal Security. GHA Board Vice-President.

Coauthor, *The ABC of Harmony*: [www.peacefromharmony.org/?cat=en\\_c&key=478](http://www.peacefromharmony.org/?cat=en_c&key=478).

**Address:** Sociology Department of Azad University, Daneshjoo Blvd. Garmsar, Iran – P.O Box: 3581631167

**Web:** [www.SocietalSecurity.com](http://www.SocietalSecurity.com)

**E-mail:** [navidnia@hotmail.com](mailto:navidnia@hotmail.com), [navidnia@societalsecurity.com](mailto:navidnia@societalsecurity.com)

## 23. David Robert Ord.

Multifaith.

He is editorial director of Namaste Publishing, a multifaith practitioner who is a former Presbyterian (USA) minister and a graduate of San Francisco Theological Seminary. Most recently he is co-author, with Dr. Kurt Johnson, of the very popular book *The Coming Interspiritual Age*. He is also co-author with Dr. Robert B. Coote of *The Bible's First History—From Eden to the Court of David with the Yahwist; In the Beginning — Creation, Priestly History; Is the Bible True?; and Understanding the Bible Today*. With Namaste Publishing he has also authored *Your Forgotten Self: Mirrored in Jesus the Christ*.

**Address:** Phoenix, USA

**Web:** [www.namastepublishing.com](http://www.namastepublishing.com)

## 24. Abbas Panakkal

Muslim faith,  
PhD, GHA Vice-President,  
Coordinator, International Seminar on Interfaith Harmony and Tolerance, Malaysia,  
Professor, Ma'din Academy,  
**Address:** Vegara, India,  
**E-mail:** [apanakkal@gmail.com](mailto:apanakkal@gmail.com)

## 25. Bishnu Pathak

Hindu-Buddhist faith,  
PhD; Board Member, TRANSCEND Peace University,  
GHA Chief Coordinator: GHA Petition to the UN for Total Disarmament  
([www.peacefromharmony.org/?cat=en\\_c&key=529](http://www.peacefromharmony.org/?cat=en_c&key=529)),  
GHA Ambassador of Peace and Disarmament from Harmony  
([www.peacefromharmony.org/?cat=en\\_c&key=532](http://www.peacefromharmony.org/?cat=en_c&key=532)),  
Convener, TRANSCEND International (South Asia),  
Director, Peace and Conflict Studies Center (PCS Center).  
**Address:** P. O. Box 11374, Sukedhara  
Kathmandu, Nepal  
**Phone:** +977 1 4650696  
**Mobile:** +977 9841 345514  
**Web:** [www.transcend.org](http://www.transcend.org), [www.cscenter.org.np](http://www.cscenter.org.np),  
[www.insightonconflict.org/conflicts/nepal/peacebuilding-organisations/pcsc/](http://www.insightonconflict.org/conflicts/nepal/peacebuilding-organisations/pcsc/)  
**E-mail:** [pathakbishnu@gmail.com](mailto:pathakbishnu@gmail.com)

## 26. Steve V. Rajan

Muslim faith,  
PhD; Founder and Chairman of Borneo Open International University, USA ([www.borneo-edu.us](http://www.borneo-edu.us)); IAEWP Vice President for Strategy as well as GHA's Representative for Asia Pacific. In 2008, he had successfully organized the 18<sup>th</sup> IAEWP World Peace Congress in Malaysia. GHA Vice-President.  
**Address:** Malaysia  
Coauthor, *The ABC of Harmony*: [www.peacefromharmony.org/?cat=en\\_c&key=478](http://www.peacefromharmony.org/?cat=en_c&key=478).  
**Web:** [www.malaysian-iaewp.org](http://www.malaysian-iaewp.org), [www.welcome2peace.org](http://www.welcome2peace.org)  
**E-mail:** [steve\\_rajan@yahoo.com](mailto:steve_rajan@yahoo.com)

## 27. Maitreyee B. Roy

Hindu faith,  
GHA-India Vice-President; Coauthor, *The ABC of Harmony*:  
[www.peacefromharmony.org/?cat=en\\_c&key=478](http://www.peacefromharmony.org/?cat=en_c&key=478).  
Principal Basanti Devi College, 147B Rash Behari Avenue, Kolkata-700029. President,  
Beautiful Mind: a parental organization of special children.  
**Address:** Kolkata, India  
**Web:** [www.peacefromharmony.org/?cat=en\\_c&key=317](http://www.peacefromharmony.org/?cat=en_c&key=317)  
**E-mail:** [maitreyee25@rediffmail.com](mailto:maitreyee25@rediffmail.com)

## 28. Leo Semashko

Orthodox faith,

PhD; Philosopher and sociologist; Global Harmony Association (GHA) Founder and President since 2005. Editor in Chief, *The ABC of Harmony*: [www.peacefromharmony.org/?cat=en\\_c&key=478](http://www.peacefromharmony.org/?cat=en_c&key=478).

**Address:** Saint-Petersburg, Russia

**Web:** [www.peacefromharmony.org](http://www.peacefromharmony.org)

**E-mail:** [leo.semashko@gmail.com](mailto:leo.semashko@gmail.com)

## 29. Sunita Singh Sengupta

Hindu faith,

Ph.D., GHA Ambassador of Peace and Disarmament from Harmony for India, Professor of Organizational Behaviour, University of Delhi ([www.fms.edu](http://www.fms.edu))

Founder & Honorary Convener

Integrating Spirituality and Organizational Leadership Foundation

**Address:** Delhi, India

**Web:** [www.isolindia.org](http://www.isolindia.org)

**E-mail:** [sunita.singhsengupta@gmail.com](mailto:sunita.singhsengupta@gmail.com)

## 30. Varant Z. Seropian

Lebanese-Armenian Christian faith;

H.E. Grand Dr. Prof., GHA Ambassador of Peace and Harmony from Harmony in MENA, IAEWP-UN ESCWA representative.

Employment : Doctor Physician - Inventor - Scientist – Academician – Philosopher – Educator.

**Address:** POBox 70063 Antelias, Lebanon

**Web:** [www.iaewp.page.tl](http://www.iaewp.page.tl)

**E-mail:** [iaewp-un@live.com](mailto:iaewp-un@live.com)

## 31. Rudolf Siebert

Roman Catholic faith,

B. 1927, Professor of Religion and Society in the Department of Comparative Religion at Western Michigan University, Kalamazoo, Michigan, USA. He develops the Critical Theory of Society and Religion presented in about 300 scientific publications in 12 languages, including 28 books and 35 chapters. He is the leading researcher of the world religions Golden Rule as the first conscious principle of social harmony. Director of the two international courses: 1. "Future of Religion" in Dubrovnik, Croatia since 1975, and 2. "Religion in Civil Society" in Yalta, Crimea, Ukraine since 1999. He is the "Peace from Harmony" and GHA founder in 2005 and has the GHA highest Honorary Title: World Harmony Creator.

Coauthor, *The ABC of Harmony*: [www.peacefromharmony.org/?cat=en\\_c&key=478](http://www.peacefromharmony.org/?cat=en_c&key=478).

**Address:** USA

**Web:** [www.rudolfjsiebert.org](http://www.rudolfjsiebert.org), [www.peacefromharmony.org/?cat=en\\_c&key=51](http://www.peacefromharmony.org/?cat=en_c&key=51)

**E-mail:** [RSieb3@aol.com](mailto:RSieb3@aol.com)



### 32. Yehuda Stolov

Jewish faith,

Executive director of the Interfaith Encounter Association, an organization that works to build peaceful inter-communal relations in the Holy Land by fostering mutual respect and trust through active interfaith dialogue. Dr. Stolov has lectured on the role of religious dialogue in peace-building throughout the world. He holds a B.Sc. and an M.Sc. in Physics and a Ph.D. from the Hebrew University of Jerusalem.

Coauthor, *The ABC of Harmony*: [www.peacefromharmony.org/?cat=en\\_c&key=478](http://www.peacefromharmony.org/?cat=en_c&key=478).

**Address:** P.O. Box 3814, Jerusalem 91037, Israel

**Web:** [www.interfaith-encounter.org](http://www.interfaith-encounter.org)

**E-mail:** [yehuda@interfaith-encounter.org](mailto:yehuda@interfaith-encounter.org)

### 33. Laj Utreja

Sanatana Dharma faith;

Dr. Laj Utreja has worked in various capacities, as hands-on engineer, as technical leader in people management, and as CEO of a small business. He has been an ardent student of Sanatana Dharma for most of his adult life. His reverence for Bhagavad Geeta has in part motivated him to write his two books, "Who are we?" and "What is our origin?" He is founder of the Institute of Spiritual Healing (ISH); GHA Vice-president; Peace Ambassador, IAERP; Director, Institute of Global Harmony, Gandhi Vidya Mandir. My faith is Sanatana Dharma (the Eternal Truth); Coauthor, *The ABC of Harmony*: [www.peacefromharmony.org/?cat=en\\_c&key=478](http://www.peacefromharmony.org/?cat=en_c&key=478)

**Address:** 122 Foxhound Drive, Madison, AL 35758, USA

**Web:** [www.peacefromharmony.org/?cat=en\\_c&key=353](http://www.peacefromharmony.org/?cat=en_c&key=353)

**E-mail:** [lutreja7@gmail.com](mailto:lutreja7@gmail.com)

### 34. Rene Wadlow

Liberal protestant,

Prof.; President, Association of World Citizens,

Representative to the UN, Geneva. GHA member,

Coauthor, *The ABC of Harmony*: [www.peacefromharmony.org/?cat=en\\_c&key=478](http://www.peacefromharmony.org/?cat=en_c&key=478).

**Address:** Le Passe, France

**Web:** [www.peacefromharmony.org/?cat=en\\_c&key=272](http://www.peacefromharmony.org/?cat=en_c&key=272)

**E-mail:** [Wadlowz@aol.com](mailto:Wadlowz@aol.com)

### 35. Chintamani Yogi

Hindu faith,

Dr., GHA World Ambassador of Peace and Disarmament from Harmony,

Founding Principal, Hindu VidyaPeeth-Nepal (HVP),

Founding Chairperson, Shanti Sewa Ashram (SSA),

Patron, Youth Society for Peace ( YSP),

Founder, Society for Value Education (SVE),

Chairperson, Nepal Inter-faith Movement (NIM)

Coordinator- GNRC-Nepal.

**Address:** Po. Box: 6807, Kathmandu, Nepal; Ph. 00977-1-5527924 /5006125

**Web:** [www.cmyogi.org](http://www.cmyogi.org), [www.hvp-nepal.org](http://www.hvp-nepal.org), [www.peaceservicenepal.org.np](http://www.peaceservicenepal.org.np),  
[www.childrenspeacehome.org](http://www.childrenspeacehome.org)

**E-mail:** [mail2cmyogi@yahoo.com](mailto:mail2cmyogi@yahoo.com)

Appendix 4  
Responses on the Project during its Discussion within the UN Week of World  
Interfaith Harmony, February 1-7, 2013 and later

GHA Message

The UN World Interfaith Harmony Week, February 1-7: Invitation to Discuss the  
GHA Interfaith Harmony Project

Dear Global Harmony Association (GHA) Members and Friends around the World:

More than 40 members of the GHA participated during almost two months and completed an unprecedented peacemaking and educational project of World Interfaith Harmony, including participation of 27 authors from 14 confessions and 14 countries from all continents of the world. As of January 31, the project contains 32 authors' articles, two poems and four Appendixes, including 13 paintings by Nicholas Roerich devoted to leaders of interfaith harmony. It has 122 pages in total.

Please, see the project in the attachment. It also is published here:  
[www.peacefromharmony.org/?cat=en\\_c&key=541](http://www.peacefromharmony.org/?cat=en_c&key=541).

This unique project embodies interfaith harmony not only in its content and purpose, but also in its authors and their team work and solidary cooperation. This project is purposefully dedicated to the UN World Interfaith Harmony Week, February 1-7.

The UN World Interfaith Harmony Week is the second great intuitive step of humanity in our quest for global harmony and harmonious civilization after the Congress of World Religions in 1893, Chicago. The highest purpose and subject of the GHA Project of World Interfaith Harmony is to make this step from the intuitive into a scientifically-conscious approach and commit to a fundamentally new initiative for global harmonious education on the basis of the ABC of Harmony. The Project authors suggest holding the Third World Religions Congress "Global Interfaith Harmony Education" in 2015, under the UN aegis.

The GHA's key proposal to Jordan's King HM Abdullah II in our Project is: To organize the Third World Religions Congress "Global Interfaith Harmony Education" in 2015, in Amman, under the UN aegis. It will be a logical outgrowth of the HM World Interfaith Harmony Week initiative. It constitutes the intrinsic meaning of this project.

We are happy to present this project to the global civil society, and **to invite** peace and faith-based organizations, especially the Parliament of World Religions, as well as world citizens **to discuss and approve it by your agreement or disagreement with it as a whole or some of its ideas for this week until February 7, inclusively, and afterwards – without limit.**

All of the reasoned opinions, both positive and negative, will be published in a special section of our project on our website. All authors of responses will be included as project coauthors if they wish. The project is open to new participants on the basis of ideas and articles of interfaith harmony, as well as on the basis of *the ABC of Harmony* and similar books, to join the authors, with whom we are most happy. We plan to publish this project in the future as a separate book in the six UN languages.

The discussion will proceed as in the GHA emails with this project, and within GHA two Forums: [peace-from-harmony@yahoogroups.com](mailto:peace-from-harmony@yahoogroups.com) and [www.forum.peacefromharmony.org/viewtopic.php?f=2&t=2049](http://www.forum.peacefromharmony.org/viewtopic.php?f=2&t=2049), as well as: [gha@freelists.org](mailto:gha@freelists.org), in which you could include without problems.

- Please, invite your friends and students to actively participate in the discussion of this unprecedented project!**
- Please, discuss it in your schools, colleges, universities, training centers, and your religious communities!**
- Please, publish the project address on your websites, social networks and your emails!**
- Please, spread it actively in the global civil society, especially among the believers of different faiths in the regions of inter-religious frictions and conflicts!**

This is the peacemaking meaning of the UN World Interfaith Harmony Week! This is the meaning of peace organizations and world citizens!

Best wishes in interfaith harmony,

On behalf of the authors,

Dr. Leo Semashko,  
Project Editor,  
GHA President,  
January 31, 2013

-----

The GHA World Interfaith Harmony Project honors Jordan's HM Abdullah II's Interfaith Harmony week and has worked to embrace the totality of meaning for this United Nations event. The GHA Project covers the history of global interfaith efforts. It compares religious traditions, explaining differences but - more important - meaningful opportunities for common thinking. With new technologies, it is no longer feasible to consider religious traditions in isolation from each other. Through careful study of the documents in the Interfaith Project, anyone can readily identify the restrictions historically placed by leaders in the various religious traditions. It is the hope of the authors that this fresh thinking will lead to harmony and a more perfect approach in our individual relationships to God.

**Bruce L. Cook, Ph.D.**

President, GHA-USA

GHA Ambassador of Peace and Disarmament from Harmony

Publisher and Editor

President, World Writers Resources, Inc.

Author, **Harmony of Nations: 1943 – 2020**, Just Fiction Editions, 2012

7337 Grandview Ct.

Carpentersville, IL 60110 USA

312-859-8090

[cookcomm@gmail.com](mailto:cookcomm@gmail.com)

[www.harmonyofnations.com](http://www.harmonyofnations.com)

<http://author-me.com>

**Personal page:** [www.peacefromharmony.org/?cat=en\\_c&key=544](http://www.peacefromharmony.org/?cat=en_c&key=544)

01/02/13

-----  
Dear Leo and friends.

Firstly, congratulations to Professor Leo who could compose harmoniously, scientifically, artistically, this bouquet of flowers from different gardens, from five continents. For me, I propose a torch for this project to make it universal light of human relationships of our planet: "The GHA Torch for interfaith harmony".

**Ammar Banni**

Professor of education, Algeria  
01/02/13  
-----

Dear all interfaith friends,

I am sorry, I could not help in the project, But the quality and commitment for the Project is highly appreciable. It will help to create the religious and global harmony. We have to appreciate the works and efforts of Dr. Leo. Congratulations for this initiative. I can hope that we will achieve the objective of the project. Thank you all with high regards.

**Dr. Surendra Pathak**

GHA-India President  
01/02/13  
-----

Dear Prof. Semashko and all the respected Friends,

Hearty congratulations! Every communication that arrives from you in my inbox tells of the great commitment and clarity of approach in promoting harmony and unity. I am, indeed, very happy to read of the unprecedented peacemaking and education projects dedicated to World Interfaith Harmony. With warm personal regards. Sincerely,

**Dr. A. K. Merchant**

General Secretary, The Temple of Understanding--India;  
National Trustee, Lotus Temple & Baha'i Community of India;  
Chairperson, Sarvodaya International Trust--Delhi Chapter  
Vice President, Global Harmony Association—India  
02/02/13  
-----

Dear interfaith friends,

This project is one step forward towards our goal. Thanks to editor for his tireless effort.  
With regards,

**DR. Pravat Kumar Dhal**

GHA INDIA MEMBER  
02/02/13  
-----

Dear Leo,  
Dear Friends of Harmony,

I support this Great idea and shall take part as adherent, author and congruous participant.  
Best harmony wishes:

**Dr. Erika Lazarova,**  
Bulgaria  
03/02/13

---

Leo and friends,

Here is my support for this unique initiative, especially concerning the Parliament of the World Religions. My grandfather used to talk a lot about the first one held in 1893, in which he was active, and for this reason I became a member of the General Assembly of the second one in 1993.

As co-founder of The Abraham Federation: A Global Center for Peace through Compassionate Justice, and as its Director for Global Strategy, I hereby endorse the GHA's peacemaking and educational project of World Interfaith Harmony in support of the 2013 U.N. World Interfaith Harmony Week.

Peace, prosperity, and freedom through the interfaith harmony of compassionate justice for everyone,

**Dr. Robert Crane**  
Full Professor - Center of the Study of Contemporary Muslim Societies  
Qatar Faculty of Islamic Studies  
Hamad Bin Khalifa University  
**Tel:** +974 445 42822 **Fax:** +974 445 46620 **Mob:** +97466766013  
**Address:** P.O Box: 34110 Doha, Qatar  
**E-mail:** [rcrane@qfis.edu.qa](mailto:rcrane@qfis.edu.qa)  
**Web:** [www.qfis.edu.qa](http://www.qfis.edu.qa)  
04/02/13

---

Dear authors of Inter Faith Harmony all friends sponsoring the vision of GHA.

It is exciting to see the book on the forum. We must extend our thanks and deep regards to Leo, who has taken all the initiative of compiling the spread up documents of all authors of Interfaith Religion. I must appreciate his leadership and his command over all the honorable members who have left the traces of unquestionable support to Leos and conformed to his thinking and imagination and compiled into a remarkable document for future generation thinkers.

Thank you. Leo and all

**Dr. Maitreyee Bardhan Roy**  
Vice-President, GHA-India  
Principal, College, Calcutta, India  
04/02/13

---

Respected Prof Leo

I approve this project with full support. Interfaith Harmony is an very important need for the world and that is needed to maintain the actual peace in whole human society. Our human society is cruelly hunted by ultra-orthodox population and now we are suffering from

sectarianism globally. I do hope that the project on World Interfaith Harmony will increase the awareness among whole human population and will form strong bond of fraternity.  
Thank you very much Sir, Sincerely

**Dr. Kamlesh Choure**

India

04/02/13

-----

Dear Leo and all

I send my warm congratulations for this new project that I approve. Unfortunately due to health problems I was unable to participate this time in it. However, I will spread it into my contacts  
Have a wonderful harmonic day.

**Prof. Emeritus Dr. Ernesto Kahan**

MD University Professor - Poet – Physician

Tel Aviv University, Israel.

04/02/13

-----

Dear Leo and all GHA members:

I congratulate all of you to have helped produce a document, "World Interfaith Harmony: Internal Harmonious Potential of Religious and General Scientific Platform of the ABC of Harmony," which may indeed become a lasting contribution by the GHA toward interfaith harmony. Interfaith harmony in itself is a subset of global harmony and in that regard the document well serves the GHA charter for global harmony. This compendium of articles represents our understanding of what the individual faiths offer as well as some of the strides made in interfaith understanding and cooperation. Our understanding has been presented in various expressions of poetry, paintings and text. As such the document is the GHA gift to the civil society to move forward for interfaith harmony.

This GHA project has been proposed for:

1. Entry into UN endorsed World Interfaith Harmony Week in February 2013,
2. UN sponsored conference on Global Interfaith Harmony Education in 2015, and
3. Creation of Center for Interfaith Harmonious Education (CIHE) in the USA.

I endorse all of the above proposals with a view to develop understanding among faiths and thereby creating harmony. Love and regards,

**Dr. Laj Utreja**

GHA Vice-president; Peace Ambassador, IAEWP; Director, Institute of Global Harmony, Gandhi Vidya Mandir.

**Address:** 122 Foxhound Drive, Madison, AL 35758, USA

**Web:** [www.peacefromharmony.org/?cat=en\\_c&key=353](http://www.peacefromharmony.org/?cat=en_c&key=353)

**E-mail:** [lutreja7@gmail.com](mailto:lutreja7@gmail.com)

05/02/13

-----

Respected Leo,

Indeed it is good efforts by the authors and you towards the peace mission as well as to enrich interfaith harmony. I approve and appreciate your efforts. By the same time, it is my sincere call



to work for the harmonious interfaith relationship through ground level practical work will reach our efforts to the common man. Let we all work in this direction. In Harmony

**Dr. N.S. Ravishankar,**  
Vice-President, GHA, India  
05/02/13

---

The World Interfaith Harmony project created by GHA is a bright and fecund path for the humanity to reach the desirable Global Harmony. History of all nations provide us numerous of teaching via human fatal mistakes and egoistic, arrogant games for power and money enrichment with the use of religions. Also fanatics of religions caused and cause nowadays wars, hate and human victims, and among them thousands of kids. All religions in their base provide the message of Love, which is the critical factor to reach the global harmony and prosperity.

I hope this project to be read by humans servants of Love, who may select whatever ideas they want from this, and apply them in their life, for the achievement of the harmonic life with all fellow humans worldwide.

**Dr Takis Ioannides,**  
Poet, Athens, Greece  
08/02/13

---

If there will be no global peace there will be no survival on Earth  
If there will be no a global agreement based on harmony will be no global peace  
If there will be no tolerance will be no global agreement based on harmony  
If there will be no tolerance we will destroy the associations for harmony and peace  
The Interfaith Harmonious Education that GHA started in collaboration with other organizations is a strong tool to initiate a fruitful dialogue for and for harmony from tolerance

**Prof. Emeritus Dr. Ernesto Kahan** MD University Professor - Poet – Physician  
Tel Aviv University, Israel.  
Honorary President- Israeli Association Writers. Spanish Branch  
1st Vice President & Secretary General- World Academy of Arts and Culture USA  
Former Vice President of IPPNW (Association awarded the Nobel Peace Prize) and the actual president of the Israeli Branch  
Honorary President co Founder United Nations of Letters  
Honorary President of SIPEA – International Society of Poets Writers and Artists  
Vice President Intl Forum for Literature and Culture of Peace (IFLAC)  
Co-President -UHE- International Union of Hispano-American Writers  
Former 1st Vice President. Global Harmony Association (GHA). GHA World Harmony Creator  
09/02/13

---

Interfaith Harmony is a very important to encourage international public and private initiative for peace and person that promote the establishment of Global Harmony and Solidarity among Cultures and Nations. We call creative expressions to everybody to mobilize inner power and physical abilities for restoration and harmonious relations amongst people, space, and

community forcing us to reflect in the urgent change for the benefit of people. This awakening in Harmony can save the world from destruction.

As a writer and poet I am sure that the lack of creativity in harmony with nature is causing our current planetary situation, creativity is an affirmation of the existence of intelligence of Divine Will in our collective efforts.

**Susana Roberts**

poet/writer/ translator

Argentina

Dr. Litt Honoris Causa-WAAC-Ca-EEUU

Full Member World Academy of Arts and Culture.Ca

Vice Dir. Iflac-Argentina and Sudamerica

MCA-Bilingual-Argentina

Presd. Honoray Hispan A.Union Writers.

Honoray Member Bolivian Society of Arts

Editor Member Remes-Spain.

Member Global Harmony Association

Ambassador "The Love Foundation" Tap.FI.-EEUU

Universal Ambassador of Peace-Geneva-Suitzerland

Member Noosphere Ethical Ecological World Assembly

Member Presidium World Forum Spiritual Culture-Kazajastan

10/02/13

-----  
Dear Dr. Mazin Qumsiyeh,

Thanks you for your information about Palestine. Please, let me invite you to review Dr. Bahrah's article in the attachment and write joint paper about opportunities for interfaith harmony of Palestinian and Jewish nations as the first condition for sustainable peace between them.

Could you both write this paper in 4-6 pages (on 2-3 pages for everybody of you) with title: **Opportunities for Interfaith Harmony of Palestinian and Israelite Nations?** I will be happy to publish this article in the GHA Project of Interfaith Harmony ([www.peacefromharmony.org/?cat=en\\_c&key=541](http://www.peacefromharmony.org/?cat=en_c&key=541)), which we created for the UN World Interfaith Harmony Week.

Do you recognize this UN Week? – And the opportunities for World Interfaith Harmony? Or you recognize only eternal war between your religions and nations? Your joint article will be affirmation of your both peaceful priorities and efforts but do not militaristic and disharmonious ones. The GHA will be happy to discuss your joint peaceful and harmonious paper and no any other. It is possible for you both as very worthy scientists, intellectual, thinkers and humanists?

Could you both reply on ONE principal question for your nations: WHAT make for PEACE between them? HOW maybe PEACE among your nations? The GHA very long response: ONLY through common harmonious education ([www.peacefromharmony.org/?cat=en\\_c&key=461](http://www.peacefromharmony.org/?cat=en_c&key=461)). Do you agree with it? Maybe you both must concentrate your time and efforts in this direction on all 100% but no mutual accusations, which are infinite? What is your priority: peace or war? Who are you: peacemakers or militarists?

We, GHA, very want to hope that you are peacemakers that will be proved your joint article in the GHA Interfaith Harmony Project. We are very waiting it. You could discuss this key question for you on the GHA Forum, devoted to Interfaith Harmony here: [www.forum.peacefromharmony.org/viewtopic.php?f=2&t=2049](http://www.forum.peacefromharmony.org/viewtopic.php?f=2&t=2049). It is very good place for your peaceful dialog. Best harmony wishes,

**Dr. Leo Semashko,**  
GHA President  
18/02/13

---

Dear Leo and all,

I'm pleased on the join of Dr. Hedva and Dr. Mazin for Peace between Israel and Palestine. It would make strongly peace not only between Israel and Palestine, but also in the world for the world without wars. Just we got the light of GHA.

Dr. Mazin is very intellectual person and humanist who received Pulitzer Prize for peace. He is the man who everyone can frankly talk. As we see, any humanists don't have the border in mind.

Thanks, Dr. Hedva! Thanks, Leo! I wish peace and better future for Israelis and Palestine.

Love,

**Kae Morii,**  
Poet, Japan  
19/02/13

---

Dear Leo,

The article of Dr. Hedva Bachrach in the GHA Interfaith Project you shared is simply a regurgitation of mythologies that even intelligent Zionists have long abandoned. Even a Zionist historian like Benny Morris documented the processes of history that surrounded the creation of Israel etc. But even the regurgitation was done rather crudely and without much thought or even proper language. It is actually rather childish rants similar to those that the extremist settlers in Hebron say as they attack native Palestinians, foreign visitors, diplomats, and media. Mr Hedva would do well to read a bit of history so that his propaganda efforts would be a little more credible and perhaps worthy of an individualized response. For answers to his myths and many more similar myths, may I suggest he look at this <http://qumsiyeh.org/liesandtruths/>

Now for the issue of harmony between religions and nations etc. That is a more worthy issue. But there are many books and voluminous articles written on the subject. I myself wrote two books and over 100 articles that deal with the subject and published in many widely read journals etc. I also read many other books and can recommend a few including by Jewish intellectuals (e.g. Marc Ellis, Out of the Ashes; Mark Braverman, Judas Magnes, etc). See also

<http://qumsiyeh.org/openletterbygeorgesalzman/>

<http://qumsiyeh.org/answertorosenfeld/>

<http://qumsiyeh.org/einsteinetalonbegin/>

I do not believe in reinventing the wheel. Perhaps publishing some of the existing articles or selections from the existing books on your website maybe helpful to your readers.

Finally, I caution people from equating oppressed with oppressor, colonized with colonizers. This is a common error and a tool of the oppressor. In South Africa under apartheid, the struggle was not between black and white people but between those who supported apartheid (black and white) and those who opposed it (black and white). In the struggles in Europe between 1932-1945 it was not between a "German Nation" and a "Jewish nation" but between humans who opposed racism and those who supported it (including leading Zionists who collaborated with Nazi Germany\*).

\* See Jewish authors Lenni Brenner, 51 Documents: History of Nazi Zionist Collaboration; Edwin Black, The Transfer Agreement; Norman Finkelstein, The Holocaust Industry; Naeim Giladi, Ben Gurion's scandals) Best,

**Prof. Mazin Qumsiyeh,**  
**Palestinian**  
19/02/13

---

Dear Dr. Semashko and dear all.

While I tried to understand the other side of Palestinians, maybe not all, but really tried to in what I have written, this person is full of hate and one sided convictions. He is a perfect example of hate propaganda.

I am a mother of a son who was long ago wounded, much before the Gaza war. He almost lost his sight and had a concussion and broken parts of face by a "stone" thrown by a youngster, while he was gathering the people under his command to try and save them. Big stones also kill, you know??! Thanks God my son was saved, while many of his friends were not. Still I, and my son and his family, want peace.

This man, Mazin Qumsiyeh, I believe that he works at a Palestinian propaganda center. He has written to me hateful e-mails before. I have already started thinking ( which I thought long ago) of both parties reconstructing their homes and working together for a better future. But, Dr. Semashko, you must understand that without giving up terror, and without neglecting the conviction that they can destroy us, there can be no cooperation. As I wrote, there can be a solution for two independent states under the cover of some common upper institutions which will legally regulate the differences between the nations.

However, if I want to write an article (this is a longer article than you suggested, as many aspects should be covered) Please find another broad thinker with whom to write such an article. When a person can not get out of his hateful propaganda, and not think about the welfare of all people in the Middle east, with such a person it is hard for me to converse.

My darling Kae, thank you for your words. I am honored. Mr. Mazin should take example of the poet and artist Kae Morii, whose family was terribly harmed in the Atom Bomb in Hiroshima, and she travels around the world speaking of PEACE!! not HATE and Slander, Mr. Qumsiyeh. You say my ideas are regurgitation of mythologies?? Well have you ever had in your propaganda any constructive Idea to end this conflict, except slander?? I am very sorry for your people in prison. I wish not one of them would be there. But stop the acts of Terror or preparing for terror - which has raised its ugly head all over the world. Your side does not want to condemn terror, and it never stops it ...We have got out of the Gaza strip and have taken all our settlements out, so it is not "an occupied territory" and for 7 years they have sent missiles which kill and harm our civil population, without considering that they harm children and parents, it is not important to them; in their hate and blindness - so why do you blame us for trying to protect ourselves ???

And by the way do you understand the meaning of "Zionist"?? Zion is just another name for Jerusalem which is holy for both our nations, so this makes you also a Zionist!

**Dr. Hedva Bachrach,**  
**Israelis**  
19/02/13

---

Dear Hedva,

I asked Prof. Mazin to write the short (to 1 page) review about the ABC of Harmony (see below). Please, let us read and your review on this book asap. Is it possible for you? Thank you.

GHA will not publish or discuss any unilateral accusations, criticism and hostile attacks - it is forbidden by the GHA Constitution, our Mission and internal information order. We will publish and discuss only your peace ideas to ensure harmony between you personally, and between your nations and religions. To your peoples remain only eternal war and strife, if you, their best intellectuals, can not talk to each other about anything else except the war. Can you take a war and enmity for the brackets of your mind and intellectual communication, at least temporarily, and to express your ideas about peace and harmony of your religions and peoples?

**As you know, the war begins in the mind. Peace and harmony also begin in the mind.** If you will be able to write reviews about *the ABC of Harmony*, the GHA next step will be to invite each of you to write the 2-3 pages with your ideas of peace and harmony, ONLY. They are attended at you? If yes, please, show them to us, ONLY them. You constantly feed us your hostile ideas. Please, let us try and taste your peaceful and harmonious ideas. Have you them? Is it possible for you to glad us with a decent, but not obnoxious spiritual food? We would be very grateful to you for this food and fresh breath of spiritual air of peace and harmony from you both. Thank you very much for that and only that! We are waiting for that!

**Dr. Leo Semashko,**  
GHA President  
19.02.13

-----  
Dear Hedva and Mazin,

You write that you had 8 wars during 64 years. It's very sad. But why is this happening? I think the reason is that you only think about the war. We did not read any more of your pages dedicated to 100% peace between your peoples and religions. In this state of your minds you will have 80 more wars during 640 years. And so on to infinity. WHO will establish peace between you and your nations, if you think and write only about the war? WHO? Jean of Rwanda? Leo from Russia? Kae from Japan? - No one but you only.

This requires that you start to think and write about peace. I invited you twice and now I ask for the third and last time to write: 1. Short, up to 1 page review on *the ABC of Harmony*, which is designed for world peace ([www.peacefromharmony.org/?cat=en\\_c&key=478](http://www.peacefromharmony.org/?cat=en_c&key=478)), and 2. The 2-3 pages of your ideas about peace, about how maybe peace among of your peoples and religions. I and GHA will be discuss only like your writings and no other. Both of you accused me in disrespect. However, your persistent ignore all my letters with my invitations is disrespectful to me and the GHA.

You write to me "long letters that did not address the peaceful substance of my letters". I will not respond to such emails. Yes, GHA can not respect your militarist writings. We can only respect your peacemaking writings about your interfaith harmony. But we do not see them. Please, show them to us.

**Dr. Leo Semashko,**  
GHA President  
21/02/13

-----  
Leo,

The preminent leaders of Christianity and Islam are retiring almost on the same day. Each leaves a legacy of harmony in a chaotic world.

Perhaps next year the award should be given to him. I'll have to look at the United Nations award to him for his quotes on harmony and justice.

Today, God willing, I will write a review of the GHA's book.

**Dr. Robert Crane**

Full Professor - Center of the Study of Contemporary Muslim Societies  
Qatar Faculty of Islamic Studies  
Hamad Bin Khalifa University  
Tel: +974 445 42822 Fax: +974 445 46620 Mobile: +97466766013  
Address: P.O Box: 34110 Doha, Qatar  
E-mail: [rcrane@qfis.edu.qa](mailto:rcrane@qfis.edu.qa)  
Web: [www.qfis.edu.qa](http://www.qfis.edu.qa)  
25/02/13

-----  
Dear Robert,

Legacy of harmony in the world remains chaotic because all the leaders, including religious leaders and the UN, are totally ignorant in common science of social harmony, which is represented in *the ABC of Harmony*. Only on the basis of its knowledge, they can join together to harmonize purposefully the world from different perspectives: in religions, in politics, in the economy, in the information and etc.

Who may interests the world's leaders, including religious, learn *the ABC of Harmony* and educate in it? Only then they will be able to provide global justice and peace in the world, based on scientific knowledge of social harmony. Only this knowledge provides a regime and order of most favored conditions and opportunities for the development of each and any part (group, nation, culture, religion, etc.) of the world as a whole, in all holistic and integral system of its interdependent parts. No other value, or an idea, or knowledge is not able to provide this global regime and world order of most favored for each of its parts, including every person on Earth of 7-10 billions.

Therefore, your review about *the ABC of Harmony*, like everyone, is very of current importance and waiting for its understanding and recognition as a key knowledge of modern humanity to overcome his total ignorance in harmony, which prevents to his harmonious education and unity in harmony of all its diversity.

Maybe you and Islamic world will understand and recognize it first?

**Dr. Leo Semashko,**  
GHA President  
25/02/13  
-----

The UN Decade of Interfaith Harmonious Education for 2014-2024 Proposal

Dear GHA members, interfaith friends,

An excellent idea matured within the GHA: the idea UN Decade of Interfaith Harmonious Education for 2014-2024, which requires a logical and organizational completion.

**The first and most important.** Implementation of this idea will significantly enhance the harmonizing social mission of States, the UN members, and religions and their churches in the life of society through the development of global harmonious interfaith education. The issue of enhancing the social role of the state and religion through harmonious education is very important for both of them in our time of burgeoning social and religious conflicts in the world. The harmonizing social mission of state and religion is very relevant and for the population,



which faces growing global challenges demanding from them adequate responses in a non-violent way of global harmonious interfaith education, rather than on a way of global militarization and violent solutions.

**Second.** The need for global interfaith harmonious education has reached a new level to meet the challenges of globalization in the 21st century. The existing system of national, common and elite education does not respond to the global challenges of our time and fails to prepare the young generations for non-violent harmonious solutions to any social problems. This is a key flaw of modern education that can be overcome only in harmonization as in interfaith perspective, and through harmonization of science and religion.

These two key global motives determine the relevance and necessity of the UN Decade of Interfaith Harmonious Education for the years 2014-2024, which will give a good start and order for the most favorable global trends of spiritual and educational nature. The common good of this UN Decade is so obvious that it requires no special logical proofs.

Organizing to complete this idea may proceed from its initiation within the UN by any organizations involved in the UN one way or another. This can be the Interfaith Coalition of Partnership with the UN, or the head of any state who can offer this idea in the UN General Session. Obviously, the most logical initiator of this idea may be Jordan's King Abdullah II as the initiator of the World Interfaith Harmony Week in the UN, 2010.

In this regard, we propose to add the GHA offers to Jordan's King in the GHA Project of Interfaith Harmony as a new, ninth point with the following content:

***Initiate in the UN, as a development of initiative 2010, a proposal of the UN Decade of Interfaith Harmonious Education for 2014-2023, which will strengthen a harmonizing mission of state and religion in global society in a non-violent peacemaking way of qualitative renewal of the education system in the world, especially in the direction of interfaith harmony instead of militarization.***

**We offer within three days, until March 5, inclusively, to discuss this proposal and include it in the GHA Interfaith Harmony Project, in section 9: [www.peacefromharmony.org/?cat=en\\_c&key=541](http://www.peacefromharmony.org/?cat=en_c&key=541).**

We understand that the common benefit of this proposal is so obvious that it requires no special discussion. There may be a difference only in the formulations of this proposal. Therefore, in this case, we will take your silence as a sign of consent and approval of this proposal and welcome all of its amendments to improve it. Thank you for supporting this proposal.

Best harmony wishes,

**Dr. Leo Semashko**, GHA President  
**Dr. Bruce Cook**, GHA-USA President  
02/03/13

-----  
This is great work! I am in Seattle right now as we just finished up a 5 day strategic planning meeting with International Leaders of The Global Peace Foundation.

We had national leaders from:

- Asia (Korea, China, Japan, Nepal, India, Mongolia, Indonesia, Malaysia and Philippines)
- Africa (Nigeria, Kenya, Uganda, South Africa & Zimbabwe)
- Latin America (Brazil & Paraguay)

- USA- Many cities
- Europe (Germany & Britain-Ireland)

One of GPF's 3 main planks is interfaith cooperation.

We will be having Global Peace Conventions in 2013 in Mongolia, Nigeria & Malaysia that you are all welcome to attend. <http://www.globalpeaceconvention.org/>

**Peter Hayes**

The Global Peace Foundation

Seattle, USA

02/03/13

-----

Peter ... it sounds wonderful but from an outsiders perspective ... what does it mean. Most of these terms would seem to have special meaning to GHA members but to outsiders it seems simple platitudes. "anti violent, interfaith harmonious education," means exactly what?

**Jerome J. Peloquin**

02/03/13

-----

Dear Peter,

Many thanks for your appreciation of the GHA work and your kind invitation to your wonderful Global Peace Conventions in 2013. We could offer to your remarkable Foundation the new peace leaders from India, Ghana, Latin America, Russia, Kazakhstan and other countries.

We have carefully reviewed your website and have found several common peace directions: education, interfaith harmony and cooperation, culture of harmonious peace and family. They are very interesting to us, because the GHA Mission is: *"To bring peace from harmony and to pave a conscious way for harmonious civilization on scientifically based 'ABC of Harmony' through harmonious education"*, or in short: "Peace from Harmony" ([www.peacefromharmony.org](http://www.peacefromharmony.org)).

For the GHA the Interfaith Harmony Project is only one of the ways to a global peace and we would be happy to cooperate with your Foundation in this project ([www.peacefromharmony.org/?cat=en\\_c&key=541](http://www.peacefromharmony.org/?cat=en_c&key=541)), as in others. During the past 8 years GHA has created 42 peacemaking projects to implement our mission ([www.peacefromharmony.org/?cat=en\\_c&key=472](http://www.peacefromharmony.org/?cat=en_c&key=472)). We would like to offer two of them for your strategic planning (plus the Interfaith project, based on the global textbook *the ABC of Harmony for World Peace* ([www.peacefromharmony.org/?cat=en\\_c&key=478](http://www.peacefromharmony.org/?cat=en_c&key=478))). It defines global harmonious education and consciousness as the deepest spiritual foundation for Global Peace and Sustainable Development. These two projects are:

1. The GHA Petition to the UN for Disarmament within 50 years, for which we need to collect 1 million signatures by September 21, 2013 ([www.peacefromharmony.org/?cat=en\\_c&key=529](http://www.peacefromharmony.org/?cat=en_c&key=529)). Could you help us collect these signatures? Could you turn this project into your strategy?

2. The New Global Peace Movement from Harmony for the 21st century ([www.peacefromharmony.org/?cat=en\\_c&key=532](http://www.peacefromharmony.org/?cat=en_c&key=532)), as now in the world there is no united peace movement, whereas the threat of a world war is increasing along with the arms race. Only such projects are able to embody the great imperative of Martin Luther King Jr.: "We must shift the arms race into a race of peace and harmony."

The above three projects, we are assured, are worthy of Strategic Planning of your wonderful Foundation. We look forward to full cooperation between our related peace organizations. Best harmony wishes,

**Dr. Leo Semashko**  
GHA President and  
**Bruce L. Cook, Ph.D.**  
President, GHA-USA  
04/03/13

-----

Dear Leo, all GHA members, Friends,

I absolutely agree that the idea UN Decade is really excellent. Among the problems that reflect current global situation - emerging confrontation and how to manage it effectively (as possible). Fortunately, the chain of confrontations – from misunderstanding to military face-off – is not an uncontrolled chain reaction.

It's really true that "the existing system of national, common and elite education does not respond to the global challenges". That's why mission of education as well as includes: systematic and timely identification and record of contradictions, an analysis of causes, using **appropriate** tools, programs to settle them. There are all the way to harmonize the international community.

**Raissa K. Kaziyeva**  
Global Harmony Association (Kazakhstan), Vice-president,  
Doctor in Economics, Professor,  
T. Ryskulov's Kazakh Economic University,  
Expert on franchising and Central Asian countries  
Address: Almaty, Kazakhstan  
Email: [RKaziyeva@gmail.com](mailto:RKaziyeva@gmail.com)  
Mob. +7 701 24 29 408  
03/03/13

-----

Dear Nina,

Thank you for your support and interest,

We will invite Leo Semashko and his organization, following your advice.

You raise several interlinked issues. "Multifaith" is a wider concept than "interfaith".

We shifted from "interfaith" to "multifaith" because of two main reasons.

- The first is a political one: the main open reason given by the European Union for opposing to a UN Decade of Interreligious Dialogue and Cooperation for Peace was that the UN is not an appropriate body for promoting or organizing such a dialogue.

- In practical terms, many of the ongoing programs of cooperation between religious inspired communities or organizations and UN sponsored programs (as those of UNAIDS) involve at field level only organizations or communities identified with only one religion, which usually is the dominant religion in that country or region.

- So, a multi-religious approach permit interreligious activities when social conditions are favorable, but also permit to mono-faith organizations participate in the initiative.

Philippines used to be an important actor in this field, but always focusing on interreligious dialogue aimed at solving hot conflicts, closely related to "culture of peace" and associated to UNESCO. We certainly don't want to exclude neither Philippines as political actor in this field, nor UNESCO as UN partner, nor "culture of peace" as important theme. Nevertheless we want to avoid being captured by the "black hole" of "interreligious dialogue and culture of peace" as unfortunately happened with the Decade Initiative. Our clear focus now is on what SG Ban Ki-moon calls "transformative partnerships", action oriented partnership.

Whenever you like we can have a conversation on all these matters through Skype. My Skype identity is gerardo.gonzalez97. Best regards

**Dr. Gerardo Gonzalez,**  
Executive Secretary  
Multi-Faith Coalition for Partnering with the United Nations  
Chile  
03/03/13

---

Dear Interfaith friends and partners  
I am fully supportive of the idea hoping it matures into an initiative  
Love and respect to all

**Sheikh Maytham Al Salman**  
Bahrain Interfaith  
04/03/13

---

Dear All,  
I am too in total agreement.  
Salam,

**Din Syamsuddin**  
04/03/13

---

I say this reluctantly, but I fail to see any mention of Justice as an essential condition for achieving Peace, Harmony or Love. I totally agree with Pope Paul VI that "If you want Peace, work for Justice." For definition of such terms as "Justice," "Social Justice," or Economic Justice" see the Just Third Way Glossary at <http://www.cesj.org/definitions/glossary.html>. For a vision that would deliver Peace, Prosperity and Freedom through Justice for all, see <http://www.cesj.org/thirdway/paradigmpapers/jtw-greengrowth.pdf>.

While the UN, the US, the Eurozone countries and all other nation states are failing to address the injustices of the global economy, the good people now associated with GHA can succeed in leading the way to a solution by reflecting on the message delivered in 1987 by President Ronald Reagan at <http://www.youtube.com/watch?v=06vP84SqnS4>. And to strengthen the bonds of the GHA in its educational outreach to interfaith leaders and scholars in all cultures, we should all seriously consider the wisdom of other global moral leaders in the attached set of quotes.

**Norman G. Kurland, J.D.**  
President  
Center for Economic and Social Justice (CESJ)  
P.O. Box 40711, Washington, USA  
04/03/13

---

Dear Norm,

Still in 2011 year, at *the ABC of Harmony* preparation, we found with you a general formula relationship of harmony and justice: they are inseparable, justice requires harmony, harmony is impossible without justice. This is expressed in your wonderful article in *the ABC of*

*Harmony for World Peace ...* ([www.peacefromharmony.org/?cat=en\\_c&key=478](http://www.peacefromharmony.org/?cat=en_c&key=478), pp. 100-102). Why just private property (the property - for each) is not established in society for many decades, as Harold Moulton (1935), Louis Kelso and Mortimer Adler (1958) start to write about it? Why it was not possible to Ronald Reagan? Because in a society the social harmony was not, therefore, there was no social need to harmonize private property through its just distribution among all everyone to be the owner.

Why was not and there are still social harmony? Because society, including science, religion, them leaders, governments, together with the presidents and the United Nations are totally ignorant in social harmony **as the best (optimal and efficient) universal condition, mode and order of the most favored for all parts and units (groups, nations, businesses, families and people) of society as a whole, without exception. In nature and society, there is nothing better (optimal, supportive, effective, etc.) and anything with greater potential and the best opportunities for the development of each and any part of the whole, than harmony, which is the first condition of life and survival of any system.** All other values and benefits: life, peace, love, justice, freedom, brotherhood, happiness, etc. are aspects, manifestations, consequences and necessary part of harmony. This, scientific and philosophical understanding of holistic harmony was first expressed in the global textbook – *The ABC of Harmony* created by the GHA 76 co-authors from 26 countries in 2012. So when we speak "harmony", we mean "justice, peace, love, brotherhood, freedom, happiness" and all the other values and the common goods of mankind.

In *the ABC of Harmony* (pp. 13-46, etc.) the fundamental elements of harmony and human values are analyzed in four dimensions:

1. Universal – Integral/Holistic.
2. Necessary - Sufficient.
3. Internally - Externally
4. Coherent - Discoherent.

The conclusion from this analysis is one: only harmony simultaneously possesses the qualities of universality, integrity (holism), necessary, sufficiency, internally, externally and coherence. All other values: life, peace, love, justice, freedom, brotherhood, happiness, well-being, prosperity, tolerance, culture, science, religion, democracy, market, etc. (as well as the fundamental elements of harmony) are universal, but not integral/holistic; necessary but not sufficient; or internally, or externally and discoherent both internally and externally. Their coherence comes together with harmony and coherence measure is determined by the degree of harmony. This is the scientific conclusion of social harmony philosophy, presented in the first approximation in *the ABC of Harmony*. (We find it in various forms at many other authors in history). Of course, this is the eternal philosophical question that will produce the eternal philosophical debates that GHA has periodically, along with virtually every new project of global harmony. We do not intend to abandon this spiritual (interfaith and philosophical) and intellectual (scientific and sociological) tradition in the GHA, what write Bruce, Ernesto, Laj and others.

*The ABC of Harmony* for the first time in history opened a harmonious education way as overcoming a total ignorance of humanity in harmony. It opened a new era in human history - ***the Age of Harmonious Enlightenment***, which was proclaimed by the GHA on February 11, 2012 in Delhi at the International Seminar of Teachers in IASE University ([www.peacefromharmony.org/?cat=en\\_c&key=511](http://www.peacefromharmony.org/?cat=en_c&key=511)). Therefore, the UN Decade as the GHA initiative of Interfaith Harmonious Education is a logical distribution of this Age on the believers around the world. They are the most spiritual people who are able to understand and to take *the ABC of Harmony* through harmonious potential of each religion most other. They can also most other to understand and accept the idea of economic/social justice: everybody is the owner. You could use for this goal the GHA project of Interfaith Harmony and write in it your article, about such title: "Economic Justice as Interfaith and Multy-religious Harmony." Or: "Interfaith Harmony and Social Justice." And so on. In this article, you could use the rich historical

wisdom, the quotes of which you kindly have shared with us. If you want, we could write this article together. We will be to update the GHA Interfaith project in April and will be happy to add it to your (or joint) article on this subject.

This article will be of great importance, since it touches, as rightly said Bruce, GHA strategy, which includes not only the harmonious education but economic justice, and many other areas and directions submitted in the GHA 42 projects. Our Interfaith project is second after *the ABC of Harmony* global textbook, on which learn and overcome the total ignorance in harmony above all the authors, we all are, without exception. We can teach others, just learning ourselves. Harmonious Education – it is a universal prerequisite for the establishment of social harmony, economic justice, political harmony, complete disarmament, global peace, overcoming poverty and all other global and local social pathologies.

Without a harmonious education on scientific basis of *the ABC of Harmony* and similar global textbooks can not exist economic justice and global peace, no culture of peace, neither disarmament nor interfaith harmony and so on one thing of social harmony and harmonious civilization. Therefore, the famous American philosopher Dr. Glenn Martin by right appreciated *the ABC of Harmony* as "***Our new planetary paradigm, the fundamental revolution in science and paradigm shift in human consciousness***" (p. 296). We must examine ourselves this paradigm, including economic justice and interfaith harmony, to teach others. Do you agree with it?

**Dr. Leo Semashko**

GHA President

04/03/13

-----  
Dear All:

I concur with Norm in stating that it is impossible to achieve harmony without justice, whether caused by economics, politics or faith. Two of the most important factors that compromise our ability to properly and correctly address the issues that we face are the man-made divisions of the powerful and the powerless and the economics of global trade. However, unjustified wars, disproportionate wealth-gaps, inequitable access to food, healthcare, education, opportunity and fair governance remain related factors. These factors contribute to differences that cause conflicts. The differences that really cause conflict are the resulting human suffering and injustice. That's where harmony is important. Love and regards,

**Dr. Laj Utreja**

GHA Vice-president

USA

04/03/13

-----  
Hi Leo,

The Honolulu-based All Believers Network (Belnet) congratulates you and supports your vision for The UN Decade of Interfaith Harmonious Education for 2014-2024. We'll be happy to assist in whatever manner we can. Our website, [www.AllBelievers.net](http://www.AllBelievers.net), provides an idea of what we do and how.

I am also happy to reproduce below my poem, In which language does God speak?, some verses of which we recited jointly by high school students from a Buddhist school (Pacific Buddhist Academy) and a Christian school (St. Andrews Priory) as part of our observance of the U.N.-sponsored World Interfaith Harmony Day. Earlier, these were also recited at the Christmas eve observance at Honolulu' Unity Church. I will be happy to provide any additional information you might need.



**Aloha,**  
Saleem Ahmed  
1-808-371-9360  
Honolulu  
04/03/13

---

Everyone,

Speaking from the USA part of GHA, I welcome this challenge from Norm. I suggest that we view Norm's ideas as a prospective tactic to use in achieving our purposes. I have been privileged to discuss Norm's ideas at length recently as a preparation for new directions in GHA-USA and I have been impressed with their potential. (His organization, The Third Way (www.cesj.org) has a distinguished history of pursuing this economic justice.)

I look forward to an open debate in our GHA List correspondence. Perhaps the question is, can we effectively pursue peace and harmony through education and interfaith sharing alone? Or, will our efforts be too limited without also addressing social and economic justice (recognizing as Norm does that economic justice is a precondition to social justice)?

In a way, we are considering a strategy for the GHA. In another view, we may be addressing the question of our age. Yours in harmony,

**Bruce L. Cook, Ph.D.**  
President, GHA-USA  
04/03/13

---

Dear all,  
Greetings. This is a very nice idea. I support it. With regards,

**Dr. Praavt Kumar Dhal**  
GHA- INDIA CHAPTER  
04/03/13

---

Dear friends, Leo and all

I agree with Norm and Laj, that justice is important to achieve a harmonic civilization. The great question is what is first justice, tolerance or harmony? During years I have sustain that before this achievement it will be necessary to make an universal agreement towards harmony, and for that a world wide campaign for tolerance will be the key issue.

The present Interfaith Harmonious Education for 2014-2024 Proposal is important. However we should not forget the great power of people without any religion, like myself.

Another point is "harmonization of science and religion". I recognize that I do not understand if we are talking about "harmonization" of each part separately - What is harmonization of science? Maybe, what may pretend to say is the creation of a constructive dialogue among them towards a harmonic world. Made these observations I agree with the program.

**Prof. Emeritus Dr. Ernesto Kahan MD**  
University Professor - Poet – Physician  
Tel Aviv University, Israel.  
04/03/13

---

Dear friends, Namaste from Nepal.

Very glad to hear many good news and views from the circle of GHA. Well friends, we also have been practicing Interfaith Harmonious Education for many decades in Nepal. We have tried best to educate our students and awaken the educators through the VALUES BASED EDUCATION (truth, love, peace, selfless service and non violence). I feel happy to say that our institutions also can become role models for Interfaith Harmonious Education. Therefore, now at the moment I have been invited to share the VBE in Australia too. So friends, happy to share more with you all in future if you have any particular interest... Thank you sooo much. love/prayers

**Dr. CM Yogi**  
04/03/13

---

Dear Members / supportive members of GHA

The harmonious and peace-filled concept and idea is extremely beneficial and useful for promoting Universal Welfare and Universal Brotherhood. This perhaps will leave a lasting impression and impact on all the peace-loving citizens of the world. Poetically Yours

**Dr. T. Ashok Chakravarthy, D.Lit.,**  
International Poet – Review Writer  
Vice-President, Global Harmony Association,  
India  
04/03/13

---

Hello Dear all,

I do support the idea. As an Educationalist, it is very important for this decade. Thanks

**Mr Heli Habyarimana**  
Linguist, GHA Vice-President  
Assistant Lecturer & Director/Office of the Rector  
Institute of Agriculture, Technology and Education of Kibungo (INATEK)  
Rwanda-Africa  
04/03/13

---

Dear Leo and all members,

If one day, I doubt or I feel that religion is a barrier against my human relations, I will divorce with my religion because every human being is born to be free, tolerant, and accept the other. For this reason, I support this project for globalization this educational initiative by UN and by its various branches ... With harmony and respect.

**Ammar Banni**  
Professor of education  
Algeria  
04/03/13

---

I support too. Best,

**Dr. Matjaž Mulej**  
Professor Emeritus

Slovenia  
04/03/13

---

Dearest all,

About the Harmony I would like to mention something I think important, coming from the Greek ancient literature.

Diotima, the woman teacher of Socrates, when he used the word harmony, she accused him as an abusive. So if someone uses this word he is sacrilegious. Harmony was sacred, holy for Greeks.

I think harmony is a holy target, that the present humanity is not yet ready to reach it. Nevertheless, we must continue our efforts to reach it somehow, all together.

About the harmonization of science and religion.

The Greek philosopher and scientist Pythagoras asked from his "internal students", to burn all his books after his death, in order to prevent the humanity, in case his scientific discoveries and achievements to get in evil persons hands. In Greece, in the first half of previous century, a big number of scientists where also involved in the matters of religions and philosophy. In the present times only few are involved. I spoke about with young scientists and all told me that their science was very exacting and they had no spare time for other occupations.

Some years ago I published in Greece and abroad my statement that the present criminals of humanity are those scientists who offer their holy science for much money and glory, to evil people who make the wars and all other against humanity actions. Who builds the weapons, the toxics, the dangerous foods etc.? Or who is able to build them al? The scientists who own the knowledge of their science.

My proposal is to educate properly the young student, the future scientists. It's difficult to make actions with the scientists now, as there are countries whose scientists obey to religion orders, or tyrannical military governments so all other countries must build weapons to be protected.

I think that the harmonic education must be started from the family, then in schools, via TV, radio, magazines, internet. In my country, even if our spiritual civilization is alive, while the big efforts of "somebody's"... to hide it from our new generation are too strong, and in spite of the actions of some spiritual people, DISHARMONY applies...

I do agree with the Decade with many hopes.

**Takis Ioannides**

Poet, Greece,  
05/03/13

---

UN Decade of Interfaith Harmonious Education on 2014-2023 was approved in the GHA

Dear GHA members, interfaith friends,

I am happy to congratulate all of us with approval of the GHA proposal for the UN Decade of Interfaith Harmonious Education on 2014-2023. It is included in the GHA proposals to King of Jordan HM Abdullah II as the best proponent of this idea in the UN, as it develops his historic initiative for the UN Week of World Interfaith Harmony in 2010. This proposal is included in the 9th section of the GHA project and published on the website here: [www.peacefromharmony.org/?cat=en\\_c&key=541](http://www.peacefromharmony.org/?cat=en_c&key=541). More than 20 positive responses posted here, we have not received any objection against this UN Decade, which is necessary for everyone, and it is obvious without any doubts. GHA warmly thank all participants of this discussion. The final wording of this paragraph is:

9. *Initiate in the UN, as a development of your initiative 2010, a proposal of the UN Decade of Interfaith Harmonious Education for 2014-2023, which will strengthen a harmonizing mission of state and religion in global society in a non-violent peacemaking way of qualitative renewal of the education system in the world, especially in the direction of interfaith harmony and harmonious consciousness of nations, instead of militarization.*

GHA fulfilled their civic peacemaking duty before the world community: We've made all possible and the best way. We can now immerse themselves in the creation of the First World Center (School) Interfaith Harmonious Education (CIHE) in New York. We are happy to invite to the preparation of its curriculum all other interfaith and multy-religious organizations in the world and will appreciate greatly your contribution to it.

I like to bring to your attention two Power Point presentations of the ABC of Harmony as the scientific platform of interfaith harmony and harmonious education - see attachment. They are one of directions of the CIHE curriculum. The first presentation is prepared me, and the other is prepared on this basis by Dr Abbas Panakkal, GHA Vice-President of India, who spoke with it at the Seminar of Interfaith Harmony, February 27, 2013 in Kaula Lumpur, Malaysia ([http://www.peacefromharmony.org/docs/Interfaith\\_and\\_Social\\_Harmony\\_of\\_Islamic\\_World.pdf](http://www.peacefromharmony.org/docs/Interfaith_and_Social_Harmony_of_Islamic_World.pdf)). We thank Abbas for his presentation.

Both presentations are examples for each of you to prepare your personal presentation of the ABC of Harmony for CIHE. We like to invite you to such presentations, and will welcome every kind this presentation as *the ABC of Harmony* and other similar books, such as *The Coming Interspiritual Age* ([tinyurl.com/interspiritual](http://tinyurl.com/interspiritual)) and others. The diversity of these presentations will be spiritual and scientific richness of the CIHE curriculum.

Best Harmony wishes,

**Dr. Leo Semashko,**

GHA President  
06.03.13

-----  
March 14, 2013

**Monica Willard**

United Religions Initiative  
United Nations NGO Representative  
Committee of Religious NGOs  
at the United Nations, President  
International Day of Peace (Sept 21)  
NGO Committee, Co-Chair

## Global Harmonious Education and the UN

Dear Monica,

We, the GHA leaders (see below), thank you for your congratulations and your three letters (below) with your vision of the UN Decade of Interfaith Harmonious Education (UN Decade IHE), which was initiated by the GHA. The main purpose of this Decade - to create 10,000 Centers (Schools) of IHE (CIHE, Center of Interfaith Harmonious Education) in the world, each year by 1,000, primarily in the areas of religious tensions: the Middle East, Ireland, Afghanistan, Pakistan, India, Sudan, Mali, etc.

Many of us have known you for many years as the UN wise social activist, (we recognize that you are not a UN employee), who has spent years advocating various civil concerns through NGO groups in the UN, as well for your development of a positive relationship with many of the

UN departments. We understand that you share the GHA goals and projects and offer to help implement them as part of the UN's existing actions (not creating new ones, which would become mired in the conservative bureaucratic apparatus of the UN). You have rightly warned us about this obstacle, and we thank you for that.

There may be some misunderstanding of our proposed action. GHA itself does not intend to initiate the Decade in the UN. We agree with you – this would be counterproductive. Instead, we intend to initiate it only before the King of Jordan, no more. We also understand that, even in this case, this decade will face resistance from the UN bureaucracy, as you warn us. So our message is subject to two purposes: recognizing the UN's bureaucratic apparatus and cooperating with the UN as part of approved actions, working together with other NGOs.

You have addressed your email to "GHA members," so our answer is prepared by the GHA 17 leaders (see list below). Please permit us to express our (GHA) vision of the UN from the perspective of the CIHE and to explain a few basic ideas and facts. They are very important and not short.

1. In its wisdom, the UN/UNESCO has found that wars begin in the mind and consciousness. Peace also starts in the mind, but is prepared for in peaceful/harmonious upbringing and education from childhood.

2. Mind and consciousness begin with education, which is the determining factor for any social change. For example, Nelson Mandela gave the classical definition: "Education is the most powerful weapon, if you want to change the world." The same idea was expressed by Mahatma Gandhi: "If you want peace, then start with the children." That is, start with **the education** of children.

3. Please consider this question. Why has the Israeli-Palestinian war continued for 65 years and end of it is not visible? Isn't it because their schools form in children an image of another nation as a mortal enemy, who must be killed? As a result of this education, they are killing each other and will kill until they are replace the militaristic education by harmonious/peacemaking one. The people on both sides of the conflict are totally ignorant in peace by ignoring this education.

**Note.** In our philosophical lexicon "ignorance" is not an insult in any case. This is a statement of the eternal epistemological limitations of man and mankind, who will never reach full and complete knowledge. It is an absolute quality, well-known in philosophy. All people are always ignorant in one way or another. We are literate only in very narrow areas of our education and experience, and we remain ignorant in all others. (For example, I, Leo Semashko, am ignorant in physics, chemistry, biology, etc., and am literate only in the areas of special education and my experience - in philosophy and sociology.) This is typical for each person. The path from ignorance to knowledge and literacy is the eternal epistemological process of every person and of humanity in general, which comes from the one milestone of knowledge to another. For example, Newton and Einstein freed humanity from ignorance in physics, knowledge of which opened to every man the possibility of physical literacy. For this unprecedented contribution humanity will be always grateful to Newton, Einstein and other physicists. Mendeleev freed humanity from ignorance in chemistry by an unprecedented contribution which humanity will use and remember forever. Similarly, *the ABC of Harmony*, created by GHA, has opened before mankind the possibility of freeing everyone from total ignorance in social harmony through its harmonious education. This education opens before each person, government, nation and organizations, including the UN, the ability to harmoniously correctly solve all social problems. Through this unprecedented contribution of GHA, humanity will now be able to move ahead in a constant process of harmonious education of the world population from the first days of childhood. GHA offers the UN a chance to begin this historic process by the Decade of IHE, which will probably face resistance from be rejected positions of total ignorance and utter conservatism. However, our proposal is better seen as an opportunity to upgrade the UN for the global harmonization of the 21st century. If the UN ignores this path, it might well be waiting for the same infamous finale as occurred in the League of Nations in 1946.

4. All nations and peoples, with a few rare exceptions, are totally ignorant in peace from harmony without harmonious education, which synthesizes spiritual and scientific knowledge. Almost all nations teach their children the lessons of war and victory, filling the minds of new generations with ideas of war, not peace. Therefore we have not seen the end for wars. Education in the world is militaristic. For example, these textbooks rarely if ever mention Numa Pompilius, who gave 43 years of peace from harmony to the ancient Romans.

5. It is depressing to realize that the UN and governments are so ignorant in the truths of peace from harmony. They remain warlords in mind, blithely stimulating the arms race by billions of dollars daily. In ignorance 1948 the UN failed to require the Israelis and the Palestinians to teach their children the principles of unified peacekeeping training programs. The result of this ignorance was a historical mistake of endless war between them, which can be corrected only by the way of joint harmonious peace education now being offered by GHA:

([www.peacefromharmony.org/?cat=en\\_c&key=454](http://www.peacefromharmony.org/?cat=en_c&key=454)  
[www.peacefromharmony.org/?cat=en\\_c&key=461](http://www.peacefromharmony.org/?cat=en_c&key=461)).

6. Even elementary examples of harmonious education give amazing results. For example, in Singapore, after years of religious war they adopted the State Declaration of Religious Harmony in 2003, the study of which was made compulsory in all schools for all religious communities in the country. This has led to social peace on the basis of religious harmony and prosperity of the country. Similar examples are found in Malaysia and some other countries. But this experience has not become the property of all peoples and the UN has not done anything to further such initiatives.

7. A single scientific textbook is required for the universal/global peacemaking harmonious education of different people of different religions. This appeared for the first time in history in 2012 as *the ABC of Harmony*, co-founded by the 76 GHA members from 26 countries ([www.peacefromharmony.org/?cat=en\\_c&key=478](http://www.peacefromharmony.org/?cat=en_c&key=478)). This global scientific textbook opens the door for global harmonious education (GHE) in all schools throughout the world. Only GHE ensures harmonious global consciousness and global harmonious peace.

8. Fortunately there are UN state leaders, such as the King of Jordan, who understand the key peacemaking value of harmony for peace among religions and peoples. Jordan's King initiated the first-ever World Interfaith Harmony Week in 2010.

9. The next logical step of this Week is the IHO for interfaith social harmony based on the scientific basis of *the ABC of Harmony*. The GHA project of 35 members of 17 countries ([www.peacefromharmony.org/?cat=en\\_c&key=541](http://www.peacefromharmony.org/?cat=en_c&key=541)) is dedicated to IHE. In this project GHA offers the UN Decade of IHE on the basis of the ABC and similar global textbooks. This initiative in the UN can probably best be moved only by the King of Jordan as a continuation and development of his previous initiative. It makes sense of along with the GHA project of Interfaith Harmony.

10. If wars and peace keep education in mind, the key should be the UN Decades developing different directions of harmonious education - interfaith, women's, youth, environmental, peace, etc. If the UN rejects the UN Decade of IHE, one can expect the UN's continuing total ignorance of social harmony, just as the UN did 65 years ago. The first step in saving this fate for the UN would be the IHO Year (as the most important form of global harmonious education today) based on the scientific *ABC of Harmony* for UN staff and permanent representatives of member states. GHA is ready to prepare for UN CIHE the relevant curriculum and implement it, of course, with your (UN) participation and help.

Harmonious education begins with harmonious self education as overcoming total ignorance begins with each of us. The UN reform ideas are based on global harmony and education as the GHA presented in the "Magna Carta of Harmony" (2006: [www.peacefromharmony.org/?cat=en\\_c&key=3](http://www.peacefromharmony.org/?cat=en_c&key=3))

Your words: **"I think your idea for a separate Decade is counter-productive to the work of the UN at this time"** are correct in the plan of realization of this idea through the UN bureaucracy. This conclusion is not supported by any of the GHA members as we believe that, in



essence, our idea is correct. Happily, you have not objected to the IHO in principle also. You write about the "great impact GHA", which in reality would be to initiate the IHO in the UN as a crucial mechanism for its renewal, at least indirectly, through the King of Jordan.

You have noted the advantages of breakfasts, speeches, prayers, shows ("Common ground for the common good"), and similar events. We agree that these are wonderful events, but sadly they are local and temporary, "here and now" and all. **They are not able to change the world to the better.** In fact, these events in the UN have little if any impact on world interfaith harmony. This brings us to the question - which is more important for progress: fundamental interfaith education in scientific knowledge of social harmony or breakfasts, speeches, and shows? This is a rhetorical question for which the answer is obvious. Benefit and impact would be greater if the UN spends less money on breakfasts but instead creates the CIHE, for example in Jerusalem or other places of religious hatred. It may be in the UN also. Martin Luther King Jr. formulated for the UN a great imperative - "Shift the arms race into a peace race and harmony." This shift can not be made by the breakfasts, speeches and shows, even the most excellent, but only the CIHEs worldwide. **Do you agree with this?**

We are also facing the Decade for Rapprochement of Cultures, 2013 -2022. Education is the core of culture. It develops and deepens culture and provides surviving friendships between different cultures. Of course, if this Decade would include an educational dimension, it will significantly increase its influence in the world. GHA will be happy to participate in it in this case. But this does not change our desire to achieve the UN Decade of IHO through the King of Jordan.

Dear Monica, we pray that you will take the lead in developing the CIHE in the UN. Educational foundations of the CIHE are *the ABC of Harmony* and similar global textbooks, for example, "*The Coming Interspiritual Age*" ([www.tinyurl.com/interspiritual](http://www.tinyurl.com/interspiritual)), the GHA Interfaith Project, "*Capital Homesteading For Every Citizen*," (2004: [www.cesj.org/homestead/capitalhomesteading-s.pdf](http://www.cesj.org/homestead/capitalhomesteading-s.pdf)), affirming the impossibility of social harmony and world peace without economic justice, and the like. This UN CIHE (school) would be a momentous historical event for the United Nations and the world at large. It would represent a conscious turn of humanity toward social harmony, overcoming total ignorance through harmonious education, launched by UN. Just such an event can make the UN a true global leader of social harmony in the 21st century. How wonderful if all the people of the world could see this role of the UN for the first time in history.

This role would be the best reformation of the UN. What a contrast with the traditional UN – seemingly powerless in the face of growing global challenges. In responding to these challenges, the UN and humanity can find the way of global harmonious education.

**Dear Monica, please, become the leader of this process in the United Nations!** This will be your most useful and great contribution! The GHA representatives at the UN, for example, Dr. Bruce Cook, GHA-USA President and Dr. Kurt Johnson, GHA-USA Vice-President, which we recommend, would be your competent assistants in this historic renewal of the UN through the IHO, through the appropriate UN School (CIHE).

Regarding the International Day of Peace - you are Co-Chair of its NGO Committee at the UN6 – you, obviously, know about the GHA Petition to the UN for Disarmament in 50 years that we started on this day in 2012 and which intends to collect 1 million signatures by the next IDP – September 21, 2013 ([www.peacefromharmony.org/?cat=en\\_c&key=529](http://www.peacefromharmony.org/?cat=en_c&key=529)). So as you can see, the GHA already is working with the UN, giving educational dimension to the International Day of Peace.

GHA always desires and intends to work in fullest accord and cooperation with any and all existing and ongoing programs and initiatives within the United Nations and the international community as long as these programs and initiatives do not reject the educational dimension. In this spirit, GHA aspires to dialogue, exchange, and understand with leaders and representatives of all other international programs and initiatives, working harmoniously with them in solidarity and synergy toward the goals mutually shared by all.

We will publish this letter on our website for the public ([www.peacefromharmony.org/?cat=en\\_c&key=5](http://www.peacefromharmony.org/?cat=en_c&key=5)) as we consider it important for the UN leadership and world community.

We are happy to cooperate with you on this fresh new direction within the United Nations.

Best harmony wishes,

Dr. Leo Semashko, GHA President, Russia,  
Prof. Ayo Ayoola-Amale, GHA-Africa President, Ghana,  
Prof. Celia Altshuler, GHA-LAC Acting President, Puerto Rico,  
Julia Budnikova, GHA-Russia Acting President,  
Prof. Uraz Baimuratov, GHA-Kazakhstan Acting President,  
Dr. Bruce Cook, GHA-USA President,  
Dr. Surendra Pathak, GHA-India President,  
Prof. Ernesto Kahan, GHA Vice-President, Israel,  
Dr. T. Ashok Chakravarthy, D.Lit., GHA Vice-President, India,  
Dr. Maitreyee Bardhan Roy, GHA-India Vice-President,  
Mr. Habyarimana Heli, GHA Vice-President, Rwanda,  
Prof. Ammar Banni, GHA-Africa Vice-President, Algeria,

**GHA-USA Vice-Presidents:**

Dr. Kurt Johnson,  
Dr. Norman Kurland,  
Dr. Nina Meyerhof,  
Dr. Charles Mercieca,  
Dr. Laj Utreja

---

---

**Monica's letters, underlined by Leo Semashko.**

Dear GHA Members,

I want to let you know that you are not working by yourselves on World Interfaith Harmony as an important issue for the United Nations. The Committee of Religious NGOs at the UN helped anchor WIHW in 2011 with a breakfast that included the partnership of:

1. The Mission of Jordan. Amb Zeid Ra'ad Zeid Al-Hussein opened the breakfast.
2. Department of Public Information sent announcements and USG Akasaka spoke
3. Alliance of Civilizations with their Director Marc Scheuer being a speaker
4. UNICEF and UNFPA had their representatives for faith based initiatives speak, Stephen Hanmer and Azza Karam.

I would also like you to know that the RNGOs organized a most successful event that was held in the General Assembly, with the President of the General Assembly and UNESCO on Feb 14, 2013. The title for this event was: United for a Culture of Peace Through Interfaith Harmony. It was cosponsored and supported by 10 Missions and 5 NGO coalitions.

I think you might be interested in hearing the speeches and prayers that were shared on Feb 14. I have attached the draft program that includes all the speakers with their identification and two collages of photos that share the speakers and the religious representatives. Enjoy!

You can watch this 2 hour program on the UN website:  
<http://webtv.un.org/watch/united-for-a-culture-of-peace-through-interfaith-harmony/2165451739001/>

This was the second such event in the General Assembly, working with the President of the General Assembly. The first was held during World Interfaith Harmony Week, 2012. The title for the 2012 event was Common Ground for the Common Good.

To see the event from 2012, you can go to: <http://www.unmultimedia.org/tv/webcast/2012/02/common-ground-for-the-common-good-on-the-occasion-of-the-world-interfaith-harmony-week.html>

When I encourage you to consider how to embrace an already proclaimed Decade for Rapprochement of Cultures, 2013 -2022, and to use the International Day of Peace theme, Education for Peace to emphasize Interfaith Education, I come with experience and knowledge of the UN and the value of Interfaith Harmony that is already being recognized in that system.

**You can have great impact if you will embrace what is already happening instead of working to create a new Decade.**

May Peace Prevail on Earth,  
Monica

---

**Monica Willard**

631-697-7972

United Religions Initiative

United Nations NGO Representative

Committee of Religious NGOs

at the United Nations, President

International Day of Peace (Sept 21)

NGO Committee, Co-Chair

March 6, 2013

---

Dear Leo and all the GHA Members,

I congratulate you on your efforts and recognize the importance of Interfaith Education. I want to encourage you to incorporate this focus into the already proclaimed Decade for Rapprochement of Cultures, 2013-2022. UNESCO is in charge of this Decade. It was proposed by Krygyzstan and adopted in Dec by the General Assembly. So far, they don't even have a launch date for this Decade we are in.

It is much easier to get included in a Decade that is already approved than to work on getting a new decade with a similar theme considered. You could also put your energy into creating the content for participation instead of working to get a Decade created. I encourage you to ask Jordan to include Interfaith education as part of this important Decade that is about to be launched. If you want to do that, you will have help from people in NY.

Having worked on the Decade for Interfaith Cooperation for Peace, Development and Understanding from 2007-10, I know first hand that getting a Decade on Interfaith anything proclaimed is not easy. You already have a decade proclaimed that can easily include your emphasis. Please use it to promote the importance of Interfaith Harmony and Education!

You also have an ideal emphasis with the theme chosen by the UN for the International Day of Peace, Education for Peace. You can use IDP, Sept 21, as a core component in your work this year.

If you are interested in either of these ideas, I would like to continue to be on your list and work with you. If neither of these ideas are to your liking, I would like to be taken off your list. **I think your idea for a separate Decade is counter-productive to the work of the UN at this time.** A new Decade is not something I am willing to even consider when there is so much already available through approved resolutions. I can assure you that I will be working with others to accomplish Interfaith Education and Harmony as important parts of the Decade for

Rapprochement of Cultures and IDP 2013. I invite your participation and leadership in making it happen. May Peace Prevail on Earth,

**Monica Willard**

March 6, 2013

---

Dear Leo,

You have some great ideas and I would suggest that you find a way to incorporate your wonderful information through UNESCO. They are already working on the UN Decade for Rapprochement between Cultures, 2013-2022. It seems to be a well kept secret now, but **establishing another Decade is very difficult**. Better to find a way to work with the system that is in place and help expand their outreach.

I don't know who is organizing the Decade in Paris. NY is not clear about their launch yet either. Interfaith is an important component in this already set decade. Maybe you can suggest harmonious education as a subtheme. That way you can put your work into getting the message out instead of creating a mechanism to do that. Good luck.

Peace,

**Monica Willard**

March 2, 2013

---

